



### Main

Range of Product	Modicon TM5
Product or Component Type	Counter module
Product Specific Application	Downcounting Frequency generator Upcounting Period measurement Frequency meter Axis following with encoder
Function of module	2 x 24 V DC auxiliary inputs 24 V DC encoder power supply
Discrete input number	1
Counting frequency	100 kHz
Encoder type	1 incremental encoder

### Complementary

Range Compatibility	Modicon LMC058 Modicon M258
Product Compatibility	Logic controller Motion controller
Counter inputs resolution	16 bits/32 bits
Maximum cycle time	2 ms
Input compatibility	1 incremental encoder (24 V)
Isolation	500 Vrms AC insulation between channel and bus
Discrete input logic	Sink
Discrete input voltage	24 V DC
Discrete input current	3.3 mA 24 V
Input resistance	7.19 kOhm
Current consumption	2 mA 5 V DC bus 58 mA 24 V DC input/output
Maximum power dissipation in W	1.41 W
Marking	CE
Net Weight	0.06 lb(US) (0.025 kg)

### Environment

Standards	IEC 61131-2 CSA C22.2 No 213 CSA C22.2 No 142 UL 508
Product Certifications	CSA C-tick GOST-R cULus
Ambient air temperature for operation	32...131 °F (0...55 °C) without derating horizontal installation) 32...140 °F (0...60 °C) with derating factor horizontal installation) 32...122 °F (0...50 °C) vertical installation)
Ambient Air Temperature for Storage	-13...158 °F (-25...70 °C)
Relative humidity	5...95 % without condensation
IP degree of protection	IP20IEC 61131-2
Pollution degree	2 IEC 60664
Operating altitude	0...6561.68 ft (0...2000 m)

Storage altitude	0.00...9842.52 ft (0...3000 m)
Vibration resistance	1 gn 8.4...150 Hz DIN rail 3.5 mm 5...8.4 Hz DIN rail
Shock resistance	15 gn 11 ms
Resistance to electrostatic discharge	4 kV on contact EN/IEC 61000-4-2 8 kV in air EN/IEC 61000-4-2
Resistance to electromagnetic fields	0.91 V/m (1 V/m) 2...2.7 GHz EN/IEC 61000-4-3 9.14 V/m (10 V/m) 80...2000 MHz EN/IEC 61000-4-3
Resistance to fast transients	1 kV EN/IEC 61000-4-4 I/O) 1 kV EN/IEC 61000-4-4 shielded cable) 2 kV EN/IEC 61000-4-4 power lines)
Surge withstand	0.5 kV differential mode EN/IEC 61000-4-5 1 kV common mode EN/IEC 61000-4-5
Electromagnetic compatibility	EN/IEC 61000-4-6
Disturbance radiated/conducted	CISPR 11

## Ordering and shipping details

Category	22532 - M258 PLC
Discount Schedule	PC12
GTIN	3595864074849
Nbr. of units in pkg.	1
Package weight(Lbs)	1.34 oz (38 g)
Returnability	No
Country of origin	AT

## Packing Units

Unit Type of Package 1	PCE
Package 1 Height	0.75 in (1.9 cm)
Package 1 width	2.32 in (5.9 cm)
Package 1 Length	4.09 in (10.4 cm)
Unit Type of Package 2	S01
Number of Units in Package 2	42
Package 2 Weight	3.96 lb(US) (1.794 kg)
Package 2 Height	5.91 in (15 cm)
Package 2 width	5.91 in (15 cm)
Package 2 Length	15.75 in (40 cm)

## Offer Sustainability

Sustainable offer status	Green Premium product
California proposition 65	WARNING: This product can expose you to chemicals including: Lead and lead compounds, which is known to the State of California to cause cancer and birth defects or other reproductive harm. For more information go to <a href="http://www.P65Warnings.ca.gov">www.P65Warnings.ca.gov</a>
REACH Regulation	<a href="#">REACH Declaration</a>
REACH free of SVHC	Yes
EU RoHS Directive	Pro-active compliance (Product out of EU RoHS legal scope) <a href="#">EU RoHS Declaration</a>
Toxic heavy metal free	Yes
Mercury free	Yes
RoHS exemption information	<a href="#">Yes</a>
China RoHS Regulation	<a href="#">China RoHS Declaration</a>
Environmental Disclosure	<a href="#">Product Environmental Profile</a>
Circularity Profile	<a href="#">End Of Life Information</a>
WEEE	The product must be disposed on European Union markets following specific waste collection and never end up in rubbish bins.
PVC free	Yes

## Contractual warranty

---

Warranty	18 months
----------	-----------

---

---

TM5 Slice

---

Dimensions

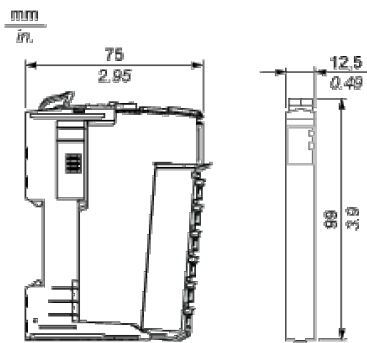

TM5 System

Spacing Requirements

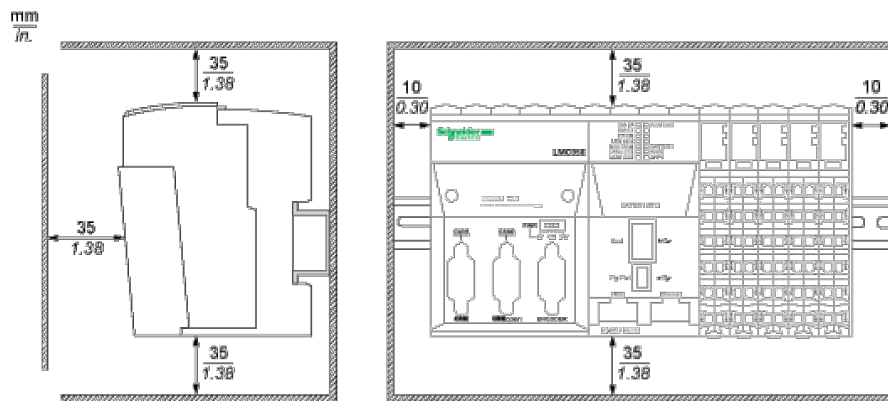

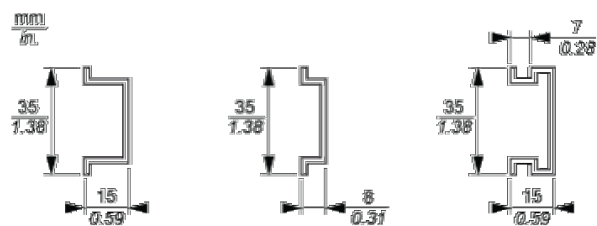

Mounting on a DIN Rail



TM5 System Wiring Recommendations

Wire Sizes to Use with the Removable Spring Terminal Blocks

mm in					
mm <sup>2</sup>		0,08...2,5	0,25...2,5	0,25...1,5	2 x 0,25...2 x 0,75
AWG		28...14	24...14	24...16	2 x 24...2 x 18

Electronic Module 1 HSC INC 100 KHz

Wiring Diagram

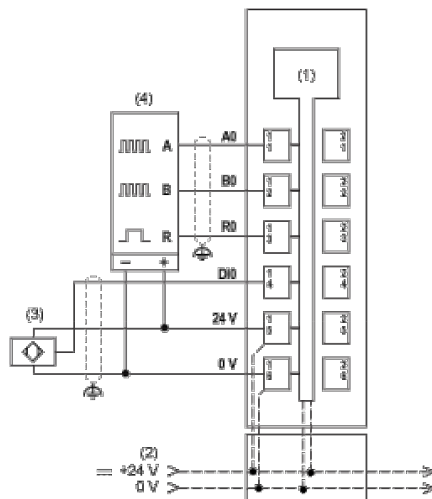

- (1) Internal electronics
- (2) 24 Vdc I/O power segment integrated into bus base
- (3) 3-wire sensor
- (4) Encoder