

UF225(85)APA series

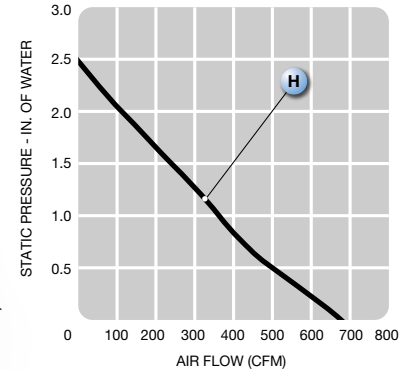

(225 dia. x 85 mm)
8.86 dia. x 3.35 inches

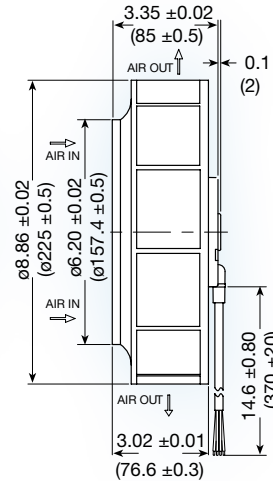
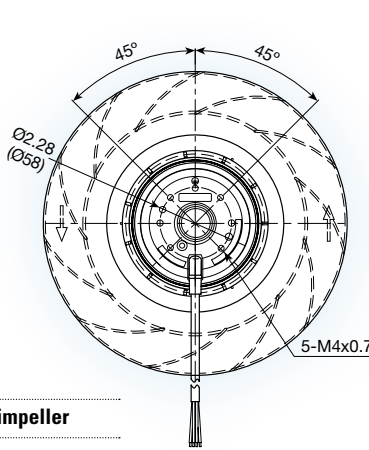

Features:	backward curved impeller
Operating voltage:	115 or 230 VAC
Operating temp.	-40° ~ 50°C
Construction:	aluminum die cast motor base; UL94V-0 reinforced nylon impeller
Bearing option:	ball bearing
Motor:	permanent split capacitor required capacitor included
Air Flow:	centrifugal
Connection:	AWM 2517 lead wires
Protection:	thermal
Option:	tachometer output

Model No.	Rated Voltage V	Freq. HZ	Input Power W	Rated Cur. A	Locked Cur. A	Speed RPM	Air Volume		Max. Static Pressure (H ₂ O)		Sound Noise dbA	Weight kg
							M ³ /Min.	CFM	MM	INCH		
UF225(85)APA12-H1C2A	115	60	135	1.20	2.30	3,000	19.2	680	64	2.5	75	2.3
UF225(85)APA23-H1C2A	230	60	135	0.60	1.15	3,000	19.2	680	64	2.5	75	2.3

