

Q56-2Q56-200GB-PDAC1MIBLZ-C

MSA and TAA Compliant 200GBase-CU QSFP56 to 2xQSFP56 Infiniband HDR Direct Attach Cable (Passive Twinax, 1m, LSZH)

Features

- PAM4 modulation
- MEET SFF-8636
- MEET IEEE802.3bj & IEEE802.3cd
- Support I2C two - line string interface, easy to control
- 1m length
- Low crosstalk
- Low power
- Operating case temperature: -20°C to +75°C
- Hot pluggable
- RoHS Compliant



Application

- 10G/40G /100g/200G Ethernet
- Infiniband SDR, DDR, QDR, FDR, EDR, HDR SWITCH
- Router Concentrator
- Data center, cloud server

Product Description

This is a MSA compliant compatible TAA compliant 200GBase-CU QSFP56 to 2xQSFP56 200G direct attach cable that operates over passive copper with a maximum reach of 1m (3.3ft). It has been programmed, uniquely serialized, and data-traffic and application tested to ensure it is 100% compliant and functional. This direct attach cable is TAA (Trade Agreements Act) compliant, and is built to comply with MSA (Multi-Source Agreement) standards. We stand behind the quality of our products and proudly offer a limited lifetime warranty.

ProLabs' direct attach cables are RoHS compliant and lead-free.

TAA refers to the Trade Agreements Act (19 U.S.C. & 2501-2581), which is intended to foster fair and open international trade. TAA requires that the U.S. Government may acquire only "U.S. – made or designated country end products."



Environment Performance

Parameter	Requirement	Test Condition
Operating Temperature Range	-20°C to +75°C	Cable operating temperature range.
Storage Temperature Range (in packed condition)	-40°C to +80°C	Cable storage temperature range in packed condition.
Thermal Cycling Non-Powered	No evidence of physical damage	EIA-364-32D, Method A, -25 to 90C, 100 cycles, 15 min. dwells
Salt Spraying	48 hours salt spraying after shell corrosive area less than 5%.	EIA-364-26
Mixed Flowing Gas	Pass electrical tests per 3.1 after stressing. (For connector only)	EIA-364-35 Class II, 14 days.
Temperature Life	No evidence of physical damage	EIA-364-17C w/ RH, Damp heat 90°C at 85% RH for 500 hours then return to ambient
Cable Cold Bend	4H, No evidence of physical damage	Condition: -20°C±2°C, mandrel diameter is 6 times the cable diameter.
Low Level Contact Resistance	70 milliohms Max. From initial.	EIA-364-23: Apply a maximum voltage of 20mV And a current of 100 mA.
Insulation Resistance	10 Mohm (Min.)	EIA-364-21: AC 300V 1 minute
Dielectric Withstanding Voltage	NO disruptive discharge.	EIA-364-20: Apply a voltage of 300 VDC for 1 minute between adjacent terminals And between adjacent terminals and ground.

Electrical Performance

Parameter		Requirement	Test Condition																																			
Differential Impedance	Cable Impedance	105+5/-10Ω	Rise time of 25ps (20 % - 80 %).																																			
	Paddle Card Impedance	100±10Ω	Rise time of 25ps (20 % - 80 %).																																			
	Cable Termination Impedance	100±15Ω	Rise time of 25ps (20 % - 80 %).																																			
Differential (Input/Output) Return loss SDD11/SDD22		$\text{Return_loss}(f) \geq \begin{cases} 16.5-2\sqrt{f} & 0.05 \leq f < 4.1 \\ 10.66-14\log_{10}(f/5.5) & 4.1 \leq f \leq 19 \end{cases}$ <p>Where f is the frequency in GHz Return_loss(f) is the return loss at frequency f</p>	10MHz≤f ≤19GHz																																			
Differential to common-mode (Input/Output) Return loss SCD11/SCD22		$\text{Return_loss}(f) \geq \begin{cases} 22-(20/25.78)f & 0.01 \leq f < 12.89 \\ 15-(6/25.78)f & 12.89 \leq f \leq 19 \end{cases}$ <p>Where f is the frequency in GHz Return_loss(f) is the Differential to common-mode return loss at frequency f</p>	10MHz≤f ≤19GHz																																			
Common-mode to Common-mode (Input/Output) Return loss SCC11/SCC22		$\text{Return_loss}(f) \geq 2\text{dB} \quad 0.2 \leq f \leq 19$ <p>Where f is the frequency in GHz Return_loss(f) is the common-mode to common-mode return loss at frequency f</p>	10MHz≤f ≤19GHz																																			
Differential Insertion Loss (SDD21 Max.)		(Differential Insertion Loss Max. For TPa to TPb Excluding Test fixture) <table border="1" style="width: 100%; border-collapse: collapse; text-align: center;"> <thead> <tr> <th>F AWG</th> <th>1.25GHz</th> <th>2.5GHz</th> <th>5.0GHz</th> <th>7.0GHz</th> <th>10GHz</th> <th>12.89Ghz</th> </tr> </thead> <tbody> <tr> <td>30 (1m) Max.</td> <td>4.5dB</td> <td>5.4dB</td> <td>6.3dB</td> <td>7.5dB</td> <td>8.5dB</td> <td>10.5dB</td> </tr> <tr> <td>30/28 (3m) Max.</td> <td>7.5dB</td> <td>9.5dB</td> <td>12.2dB</td> <td>14.8dB</td> <td>18.0dB</td> <td>21.5dB</td> </tr> <tr> <td>26 (3m) Max.</td> <td>5.7dB</td> <td>7.2dB</td> <td>9.9 dB</td> <td>11.9dB</td> <td>14.1dB</td> <td>16.5dB</td> </tr> <tr> <td>26/25 (5m) Max.</td> <td>7.8dB</td> <td>10.0dB</td> <td>13.5dB</td> <td>16.0dB</td> <td>19.0dB</td> <td>22.0dB</td> </tr> </tbody> </table>	F AWG	1.25GHz	2.5GHz	5.0GHz	7.0GHz	10GHz	12.89Ghz	30 (1m) Max.	4.5dB	5.4dB	6.3dB	7.5dB	8.5dB	10.5dB	30/28 (3m) Max.	7.5dB	9.5dB	12.2dB	14.8dB	18.0dB	21.5dB	26 (3m) Max.	5.7dB	7.2dB	9.9 dB	11.9dB	14.1dB	16.5dB	26/25 (5m) Max.	7.8dB	10.0dB	13.5dB	16.0dB	19.0dB	22.0dB	10MHz≤f ≤19GHz
F AWG	1.25GHz	2.5GHz	5.0GHz	7.0GHz	10GHz	12.89Ghz																																
30 (1m) Max.	4.5dB	5.4dB	6.3dB	7.5dB	8.5dB	10.5dB																																
30/28 (3m) Max.	7.5dB	9.5dB	12.2dB	14.8dB	18.0dB	21.5dB																																
26 (3m) Max.	5.7dB	7.2dB	9.9 dB	11.9dB	14.1dB	16.5dB																																
26/25 (5m) Max.	7.8dB	10.0dB	13.5dB	16.0dB	19.0dB	22.0dB																																
Insertion Loss Deviation		$-0.176*f - 0.7 \leq \text{ILD} \leq 0.176*f + 0.7$	50MHz≤f ≤19GHz																																			
Differential to common-mode Conversion Loss-Differential Insertion Loss(SCD21-SDD21)		$\text{Conversion_loss}(f) - \text{IL}(f) \geq \begin{cases} 10 & 0.01 \leq f < 12.89 \\ \{ 27-(29/22)f & 12.89 \leq f < 15.7 \} \\ 6.3 & 15.7 \leq f \leq 19 \end{cases}$ <p>Where f is the frequency in GHz Conversion_loss(f) is the cable assembly differential to common-mode conversion loss IL(f) is the cable assembly insertion loss</p>	10MHz≤f ≤19GHz																																			
MDNEXT (multiple disturber near-end crosstalk)		≥26dB @12.89GHz	10MHz≤f ≤19GHz																																			
Intra Skew		15ps/m,	10MHz≤f ≤19GHz																																			

Mechanical and Physical Characteristics

Parameter	Requirement	Test Condition
Vibration	Pass electrical tests per 3.1 after stressing.	Clamp & vibrate per EIA-364-28E, TC-VII, test condition letter – D, 15 minutes in X, Y & Z axis.
Cable Flex	No evidence of physical damage	Flex cable 180° for 20 cycles ($\pm 90^\circ$ from nominal position) at 12 cycles per minute with a 1.0kg load applied to the cable jacket. Flex in the boot area 90° in each direction from vertical. Per EIA-364-41C
Cable Plug Retention in Cage	90N Min. No evidence of physical damage	Force to be applied axially with no damage to cage. Per SFF 8661 Rev 2.1 Pull on cable jacket approximately 1 ft behind cable plug. No functional damage to cable plug below 90N. Per SFF-8432 Rev 5.0
Cable Retention in Plug	90N Min. No evidence of physical damage	Cable plug is fixtured with the bulk cable hanging vertically. A 90N axial load is applied (gradually) to the cable jacket and held for 1 minute. Per EIA-364-38B
Mechanical Shock	Pass electrical tests Per 3.1 after stressing.	Clamp and shock per EIA-364-27B, TC-G, 3 times in 6 directions, 100g, 6ms.
Cable Plug Insertion	40N Max. (QSFP56)	Per SFF8661 Rev 2.1
Cable plug Extraction	30N Max. (QSFP56)	Place axial load on de-latch to de-latch plug. Per SFF8661 Rev 2.1
Durability	50 cycles, No evidence of physical damage	EIA-364-09, perform plug & unplug cycles: Plug and receptacle mate rate: 250 times/hour. 50 times for QSFP28/SFP28 module (CONNECTOR TO PCB)

Electrical Pin-Out Details

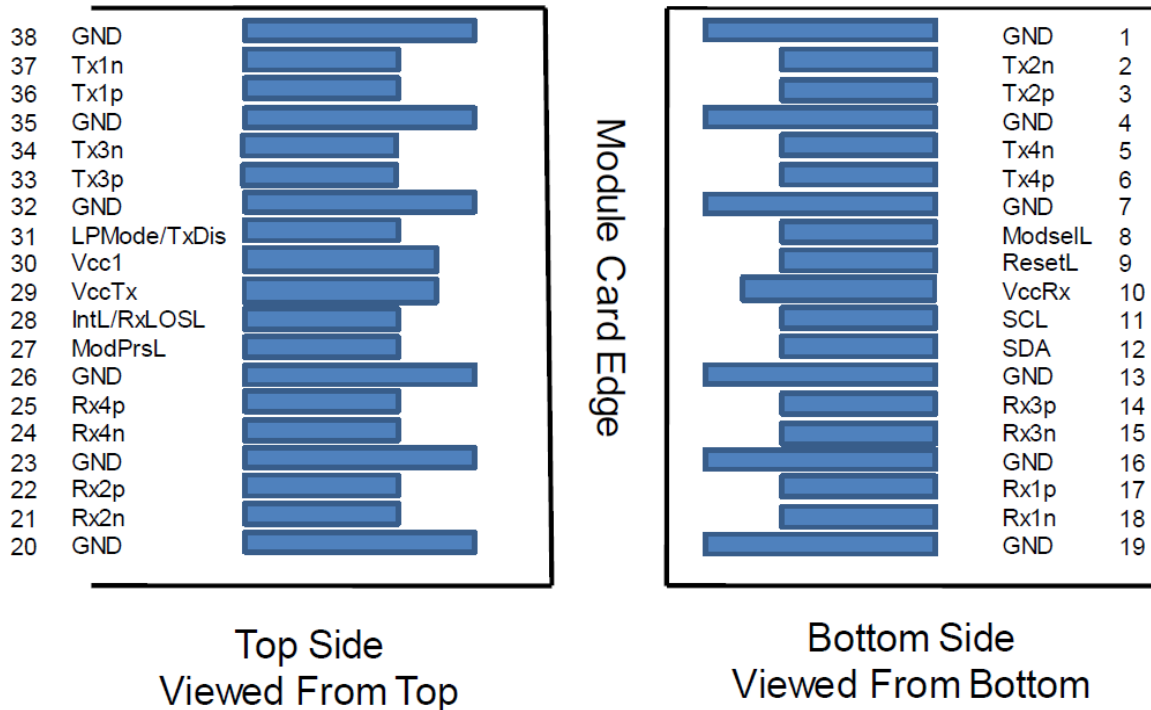

Pin Descriptions

Pin	Logic	Symbol	Description	Notes
1		GND	Ground	1
2	CML-I	Tx2n	Transmitter Inverted Data Input	
3	CML-I	Tx2p	Transmitter Non-Inverted Data Input	
4		GND	Ground	1
5	CML-I	Tx4n	Transmitter Inverted Data Input	
6	CML-I	Tx4p	Transmitter Non-Inverted Data Input	
7		GND	Ground	1
8	LVTTTL-I	ModSelL	Module Select	
9	LVTTTL-I	ResetL	Module Reset	
10		Vcc Rx	+3.3V Power supply receiver	2
11	LVC MOS-I/O	SCL	2-wire serial interface clock	
12	LVC MOS-I/O	SDA	2-wire serial interface data	
13		GND	Ground	1
14	CML-O	Rx3p	Receiver Non-Inverted Data Output	
15	CML-O	Rx3n	Receiver Inverted Data Output	
16		GND	Ground	1
17	CML-O	Rx1p	Receiver Non-Inverted Data Output	
18	CML-O	Rx1n	Receiver Inverted Data Output	
19		GND	Ground	1
20		GND	Ground	1
21	CML-O	Rx2n	Receiver Inverted Data Output	
22	CML-O	Rx2p	Receiver Non-Inverted Data Output	
23		GND	Ground	1
24	CML-O	Rx4n	Receiver Inverted Data Output	
25	CML-O	Rx4p	Receiver Non-Inverted Data Output	
26		GND	Ground	1
27	LVTTTL-O	ModPrsL	Module Present	
28	LVTTTL-O	IntL	Interrupt	
29		Vcc Tx	+3.3V Power supply transmitter	2
30		Vcc 1	+3.3V Power Supply	2
31	LVTTTL-I	LPMode	Low Power Mode	
32		GND	Ground	1
33	CML-I	Tx3p	Transmitter Non-Inverted Data Input	
34	CML-I	Tx3n	Transmitter Inverted Data Input	

35		GND	Ground	1
36	CML-I	Tx1p	Transmitter Non-Inverted Data Input	
37	CML-I	Tx1n	Transmitter Inverted Data Input	
38		GND	Ground	1

Note:

- GND is the symbol for signal and supply (power) common for the QSFP module. All are common within the QSFP module and all module voltages are referenced to this potential unless otherwise noted. Connect these directly to the host board signal-common ground plane.
- Vcc Rx, Vcc1 and Vcc Tx are the receiver and transmitter power supplies and shall be applied concurrently. Vcc Rx, Vcc1 and Vcc Tx may be internally connected within the QSFP transceiver module in any combination. The connector pins are each rated for a maximum current of 500 mA.

Wiring Diagram

wire	Starting signal	Starting	End	End signal
W1	RX1+	X1.17	X2.36	TX1+
	RX1-	X1.18	X2.37	TX1-
	GND	X1.19	X2.38	GND
	TX1+	X1.36	X2.17	RX1+
	TX1-	X1.37	X2.18	RX1-
	GND	X1.38	X2.19	GND
W2	GND	X1.20	X2.1	GND
	RX2-	X1.21	X2.2	TX2-
	RX2+	X1.22	X2.3	TX2+
	GND	X1.1	X2.20	GND
	TX2-	X1.2	X2.21	RX2-
	TX2+	X1.3	X2.22	RX2+

wire	Starting signal	Starting	End	End signal
W3	RX3+	X1.14	X3.36	TX1+
	RX3-	X1.15	X3.37	TX1-
	GND	X1.16	X3.38	GND
	TX3+	X1.33	X3.17	RX1+
	TX3-	X1.34	X3.18	RX1-
	GND	X1.35	X3.19	GND
W4	GND	X1.23	X3.1	GND
	RX4-	X1.24	X3.2	TX2-
	RX4+	X1.25	X3.3	TX2+
	GND	X1.4	X3.20	GND
	TX4-	X1.5	X3.21	RX2-
	TX4+	X1.6	X3.22	RX2+

Mechanical Specification

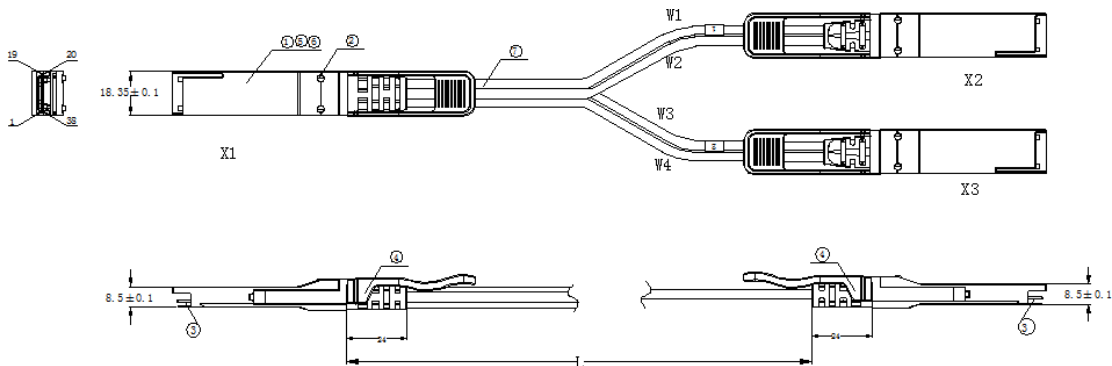

About ProLabs

Our experience comes as standard; for over 15 years ProLabs has delivered optical connectivity solutions that give our customers freedom and choice through our ability to provide seamless interoperability. At the heart of our company is the ability to provide state-of-the-art optical transport and connectivity solutions that are compatible with over 90 optical switching and transport platforms.

Complete Portfolio of Network Solutions

ProLabs is focused on innovations in optical transport and connectivity. The combination of our knowledge of optics and networking equipment enables ProLabs to be your single source for optical transport and connectivity solutions from 100Mb to 400G while providing innovative solutions that increase network efficiency. We provide the optical connectivity expertise that is compatible with and enhances your switching and transport equipment.

Trusted Partner

Customer service is our number one value. ProLabs has invested in people, labs and manufacturing capacity to ensure that you get immediate answers to your questions and compatible product when needed. With Engineering and Manufacturing offices in the U.K. and U.S. augmented by field offices throughout the U.S., U.K. and Asia, ProLabs is able to be our customers best advocate 24 hours a day.

Contact Information

ProLabs US

Email: sales@prolabs.com

Telephone: 952-852-0252

ProLabs UK

Email: salessupport@prolabs.com

Telephone: +44 1285 719 600