

POWER MANAGEMENT**Description**

The SC1301A/B is a cost effective single-channel high-speed MOSFET driver. The driver is capable of driving a 1000pF load in 20ns rise/fall time and has a 60ns propagation delay time from input transition to the gate of the power MOSFET. The high current driving capability (2A peak) allows fast switching up to 1MHz. The SC1301A is noninverting and the SC1301B is inverting.

An Undervoltage lockout circuit is included to guarantee that the driver output is low when Vcc is less than or equal to 4.1V (typ) at supply ramp up. An internal temperature sensor shuts down the driver in the event of overtemperature. The 5-pin SOT-23 package uses minimum space.

Features

- ◆ +4.5V to +16.5V operation
- ◆ Fast rise and fall times
(20ns typical with 1000pf load)
- ◆ 2A peak drive current
- ◆ Enable/disable control
- ◆ TTL-compatible input
- ◆ Inverting or noninverting versions
- ◆ Undervoltage lockout
- ◆ Low supply current
- ◆ -40°C to 85°C ambient temperature operating range
- ◆ Over temperature protection
- ◆ ESD protection
- ◆ SOT-23-5 package. Also available in Lead-free, fully WEEE and RoHS compliant.

Applications

- ◆ Switch-mode power supplies
- ◆ Battery powered applications
- ◆ Solenoid and motor drives

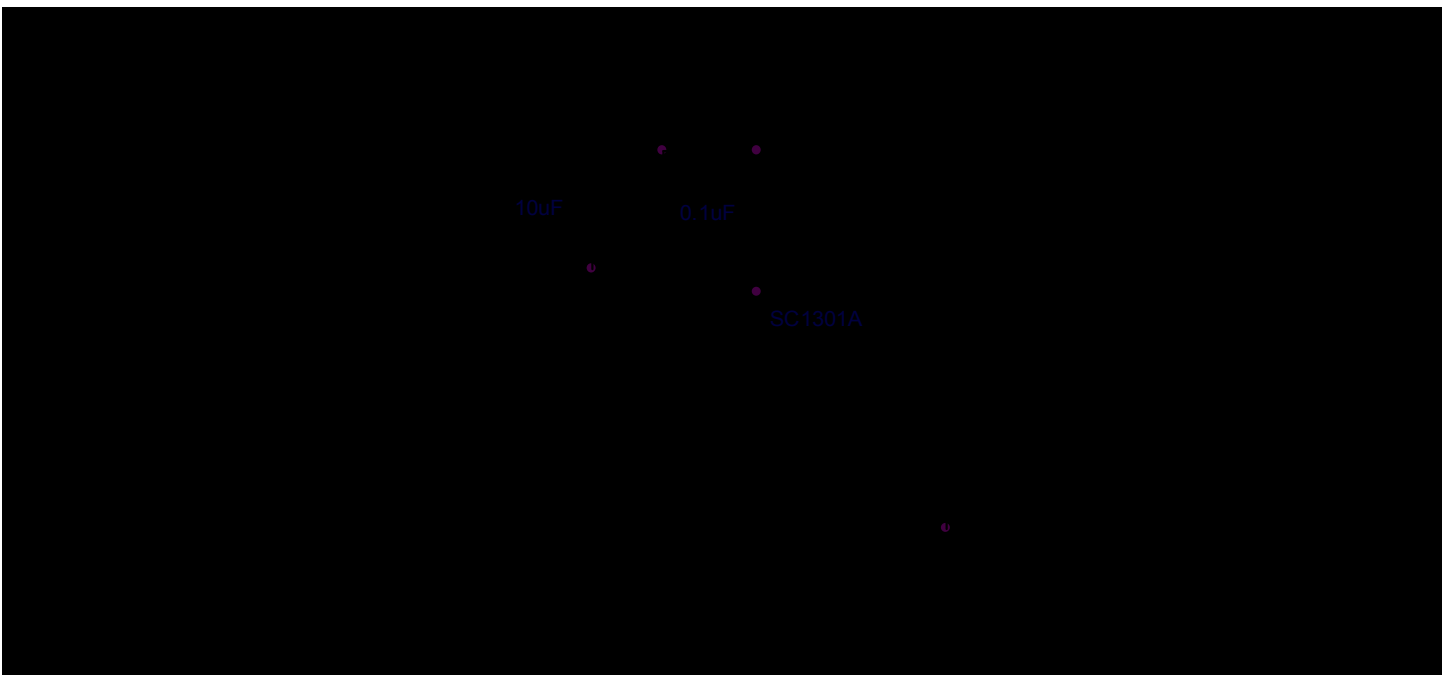
Typical Application Circuit

POWER MANAGEMENT
Absolute Maximum Ratings

Exceeding the specifications below may result in permanent damage to the device, or device malfunction. Operation outside of the parameters specified in the Electrical Characteristics section is not implied.

Parameter	Symbol	Max	Units
Supply Voltage	V _{CC}	-0.3 to 20	V
Operating Supply Voltage	V _{CC}	-0.3 to 16.5	V
Input Voltage	V _{IN}	-0.3 to V _{CC}	V
Enable Voltage	V _{EN}	-0.3 to V _{CC}	V
Continuous Power Dissipation	P _d	Internally limited	W
Thermal Resistance Junction to Ambient		260	°C/W
Operating Temperature Range	T _A	-40 to +85	°C
Storage Temperature Range	T _{STG}	-65 to +150	°C
Lead Temperature (Soldering)10 sec	T _{LEAD}	260	°C
ESD Rating (Human Body Model)	ESD	3	kV

DC Electrical Characteristics

Unless otherwise specified: T_A = 25°C, V_{CC} = 12V, V_{IN} = 5V, V_{EN} = 5V

Parameter	Symbol	Conditions	Min	Typ	Max	Units
Supply Current						
Quiescent Current	I _Q	V _{IN} = 0V for SC1301A		3.0	4.0	mA
		V _{IN} = 5V for SC1301B		3.0	4.0	
Under-Voltage Lockout						
Threshold Voltage	V _{CC}		3.9	4.1	4.4	V
Enable						
Enable Voltage	V _{EN}	0 < V _{EN} < V _{CC}	2.0			V
Disable Voltage	V _{EN}	0 < V _{EN} < V _{CC}			0.8	V
Delay to Output	t _{D_EN}	EN from low to high		60		nS
Delay to Output	t _{D_DIS}	EN from high to low		40		nS
Enable Input Current	I _{EN}	0 < V _{EN} < V _{CC}		5	12	µA
Input						
High Level Input Voltage	V _{IH}	0 < V _{IN} < V _{CC}	2.0			V
Low Level Input Voltage	V _{IL}	0 < V _{IN} < V _{CC}			0.8	V
Input Current	I _{IN}	0 < V _{IN} < V _{CC}		5	12	µA

POWER MANAGEMENT

DC Electrical Characteristics (Cont.)

Unless otherwise specified: $T_A = 25^\circ\text{C}$, $V_{CC} = 12\text{V}$, $V_{IN} = 5\text{V}$, $V_{EN} = 5\text{V}$

Parameter	Symbol	Conditions	Min	Typ	Max	Units
Output						
Output Peak Current	I_{PK_SOURCE}	$V_{OUT} = 0.5\text{V}$, $t_{PW} < 10\mu\text{S}$, single pulse		2		A
	I_{PK_SINK}	$V_{OUT} = V_{CC} - 0.5\text{V}$, $t_{PW} < 10\mu\text{S}$, single pulse		2		A
Thermal Shutdown						
Over Temperature Trip Point	T_{J_OT}			150		$^\circ\text{C}$

AC Electrical Characteristics

Unless otherwise specified: $T_A = 25^\circ\text{C}$, $V_{CC} = 12\text{V}$, $V_{EN} = 5\text{V}$, $C_L = 1000\text{pF}$

Parameter	Symbol	Conditions	Min	Typ	Max	Units
Rise time	t_R	See Timing Diagram		20		ns
Fall time	t_F	See Timing Diagram		20		ns
Propagation delay time	t_{D1}	See Timing Diagram		60		ns
Propagation delay time	t_{D2}	See Timing Diagram		60		ns

Timing Diagrams

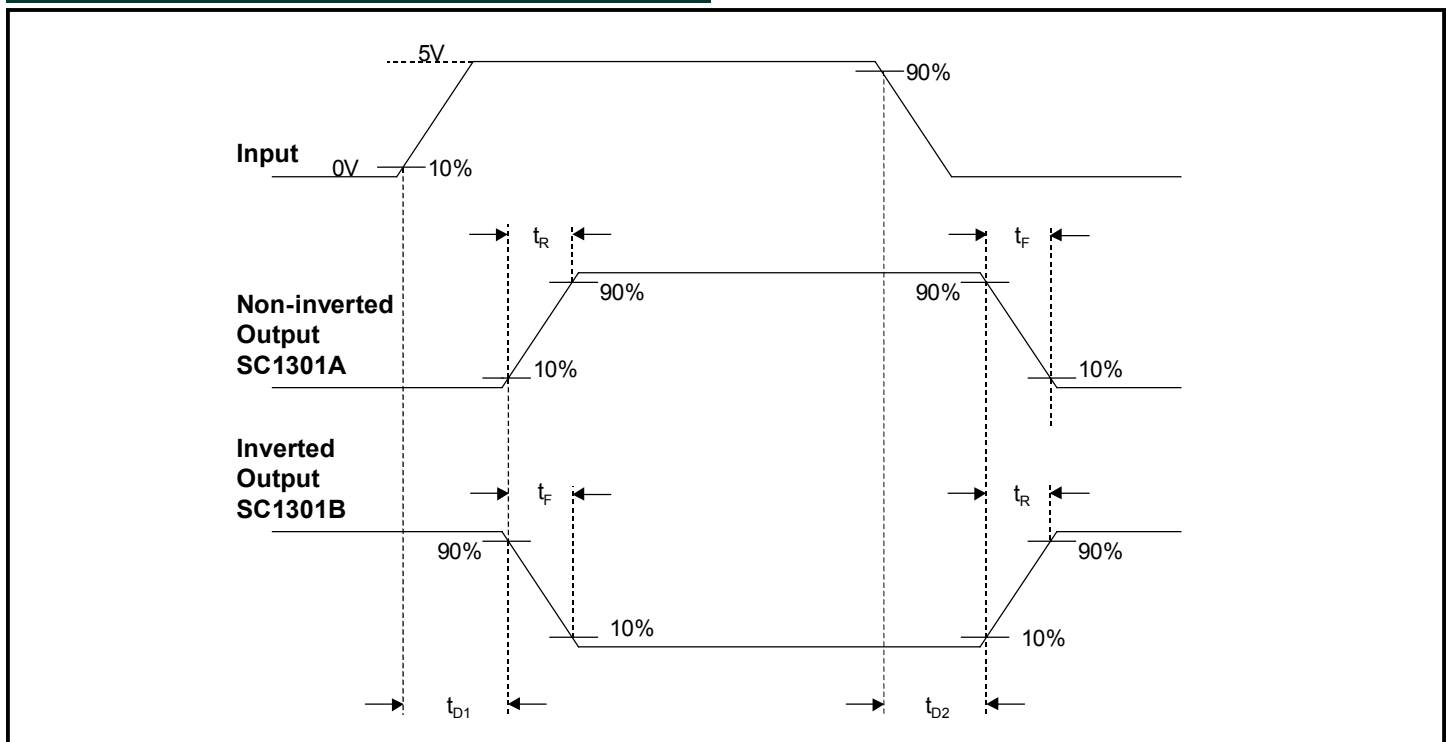

POWER MANAGEMENT

Pin Configuration

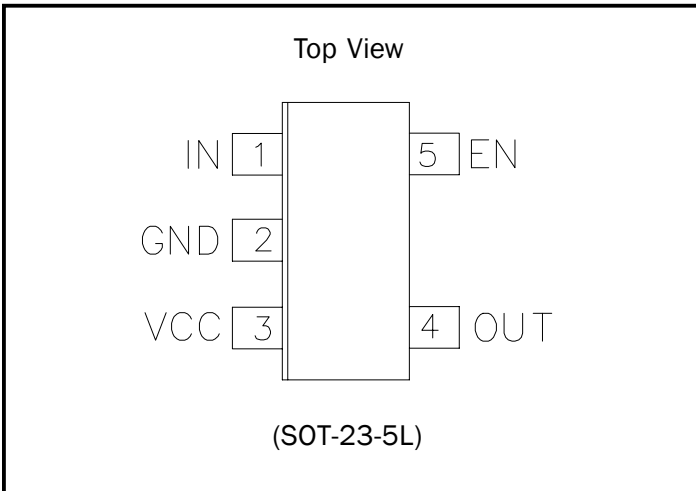

Ordering Information

Part Number	Top Mark	Package ⁽¹⁾
SC1301AISKTR	AJ0A	SOT-23-5
SC1301AISKTRT ⁽²⁾		
SC1301BISKTR	AJ0B	SOT-23-5
SC1301BISKTRT ⁽²⁾		

Notes:

- (1) Only available in tape and reel packaging. A reel contains 3000 devices.
- (2) Lead-free product. This product is fully WEEE and RoHS compliant.

Pin Descriptions

Pin #	Pin Name	Pin Function
1	IN	TTL-compatible input signal to the driver. SC1301A: Logic high forces the OUT to the VCC. Logic low forces the OUT to the GND. SC1301B: Logic high forces the OUT to the GND. Logic low forces the OUT to the VCC.
2	GND	Ground.
3	VCC	Supply: +4.5V to +16.5V supply. During UVLO, the OUTPUT is held low.
4	OUT	Output gate drive for the switching MOSFET.
5	EN	Enable/disable control. When the EN is driven low, the OUTPUT is low. When left open, the OUTPUT is low.

Block Diagrams

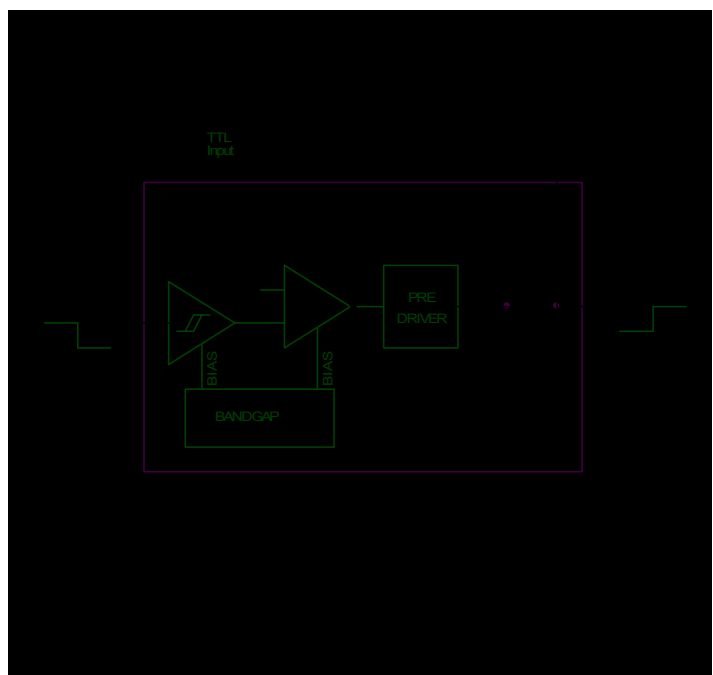
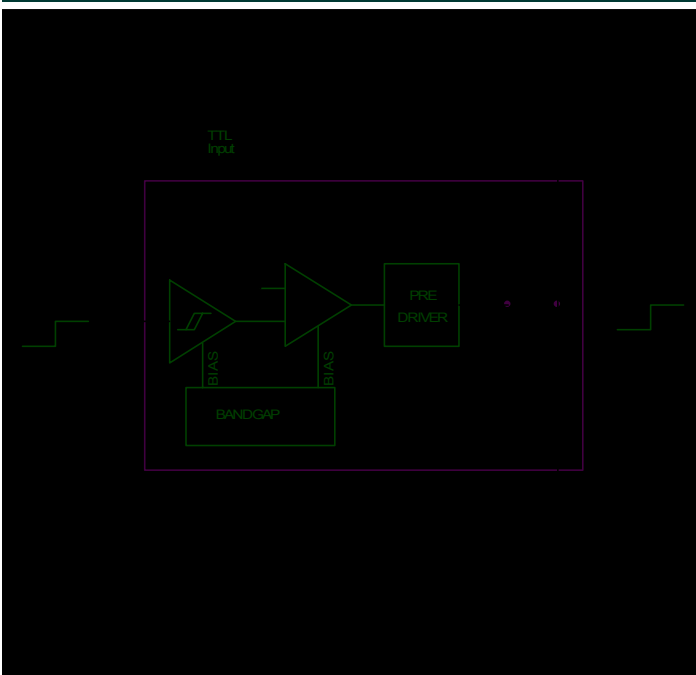

The SC1301A/B is a high speed, high peak current MOSFET driver. It is designed to drive power MOSFETs with ultra-low rise/fall time and propagation delays. As the switching frequency of PWM controllers is increased to reduce power converters volume and cost, fast rise and fall times are necessary to minimize switching losses. While discrete solutions can achieve reasonable drive capability, implementing delay and other housekeeping functions necessary for safe operation can become cumbersome and costly. The SC1301A/B presents a total solution for the high-speed, high power density applications. A wide input supply range of 4.5V - 16.5V allows operation in battery powered applications as well as distributed power systems.

Supply Bypass and Layout

A 4.7µF to 10µF tantalum bypass capacitor with low ESR (equivalent series resistance) and an additional 0.1µF ceramic capacitor in parallel are recommended to control switching and supply transients. Low ESR (equivalent series resistance) metalized film capacitors may also be used. As with any high speed, high current circuit, proper layout is critical in achieving optimum performance of the SC1301A/B. Attention should be paid to the proper placement of the driver, the switching MOSFET and the bypass capacitors.

The driver should be placed as close as possible to eliminate the possibility of oscillation caused by trace inductance and the MOSFET gate capacitance. A resistor in the range of 10Ω could be used in series with the gate drive to damp the ringing if the drive output path is not short enough. The bypass capacitors should be also placed closely between V_{cc} and GND of the driver. A Schottky diode may be connected between the ground and the output pin to avoid latch-up in some applications.

Drive Capability and Power Dissipation

The SC1301A/B is able to deliver 2A peak current typically for driving a capacitive load, such as a MOSFET. This high peak current will charge the input capacitance of the device to turn on quickly. A similar amount of current is needed to discharge the capacitance to ground to turn the device off.

Using the SC1301A/B for fast switching actions, such as turning on or turning off the capacitive load will significantly reduce the device switching loss for high frequency applications. Accordingly, the thermal stress and reliability of the device can be improved.

Due to the non-linear characteristics of the input capacitance of a device, the test load for the SC1301A/B is a capacitor. Thus, the power from the bias power supply can be calculated based on this setup. The energy, which is required to charge the capacitor for turning on process, is calculated by:

$$E_{on} = \frac{1}{2} \cdot C \cdot V^2$$

where, C is the load capacitance and V is the voltage applied to the driver.

During the turning off process, the same amount of energy will be dissipated in the resistive elements in the gate drive. Therefore, the energy for one switching action (one turning on and one turning off) will be as follows:

$$E_{total} = C \cdot V^2$$

The power dissipation due to the gate driving switching is calculated by:

$$P_{gate} = f \cdot C \cdot V^2$$

where, f is switching frequency for a given application. Below is an example to calculate the power dissipation for the given application.

With V_{cc} = 12V, C = 1nF and f = 200kHz, the power loss for the gate switching actions will be as:

$$P_{gate} = (200\text{kHz}) \cdot (1\text{nF}) \cdot (12)^2 = 29\text{mW}$$

The power supply current will be:

$$I = \frac{P_{gate}}{V_{CC}} = \frac{29\text{mW}}{12\text{V}} = 2.4\text{mA}$$

POWER MANAGEMENT**Applications Information (Cont.)****Thermal Information**

The lifetime and performance of a driver is basically determined by the drive power requirements of the load, the thermal characteristics of the driver package and its cooling method. The driver's junction temperature must be kept within the rated limit at all times. The application system has to effectively remove the heat generated in the driver in order for proper functions and performance. If the junction temperature reaches 150°C, the internal protection circuit will be triggered to shut down the gate driver.

As shown in the power derating table, the SC1301A/B has a power limit of 385mW when the ambient temperature is less than 25°C. As the ambient temperature reaches 85°C, the allowed maximum power dissipation for the driver will be 154mW. When the ambient temperature is somewhere between 25°C and 85°C, the power dissipation for the driver should be derated according to the table. For each degree increasing of the ambient temperature, 3.85mW decreasing should be applied to the driver power dissipation. Possible cooling methods may include using big pads, natural air-cooling by a careful layout and forced air-cooling if necessary.

Power Derating Table		
T_A ≤ 25°C	Derating Factor	T_A = 85°C
385mW	3.85mW/°C	154mW

POWER MANAGEMENT

Typical Characteristics

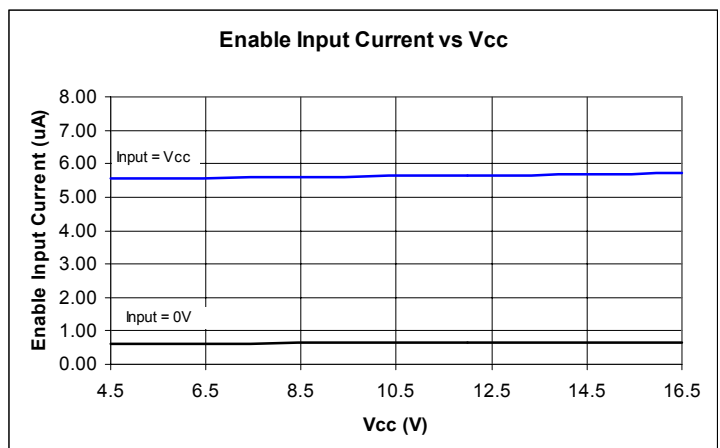
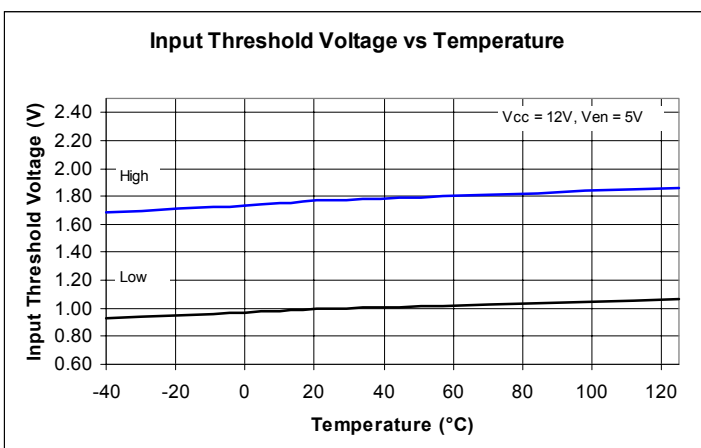
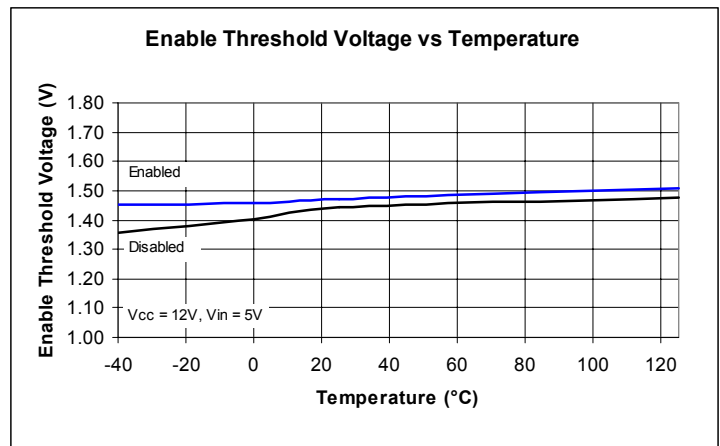
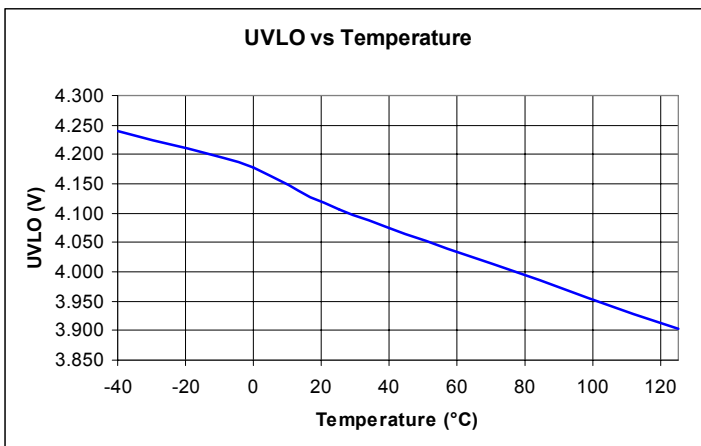
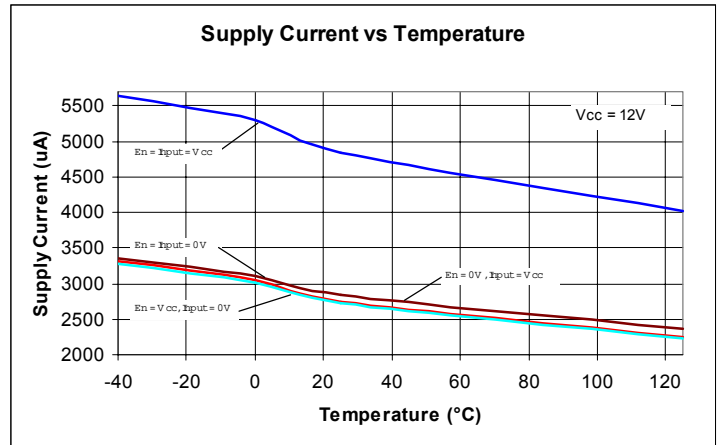
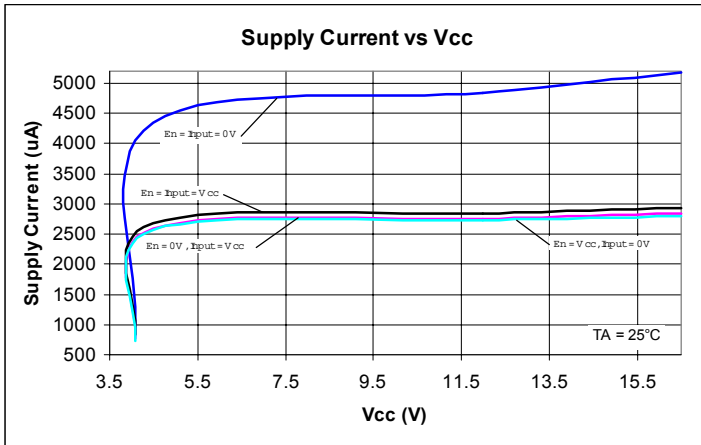

POWER MANAGEMENT

Typical Characteristics (Cont.)

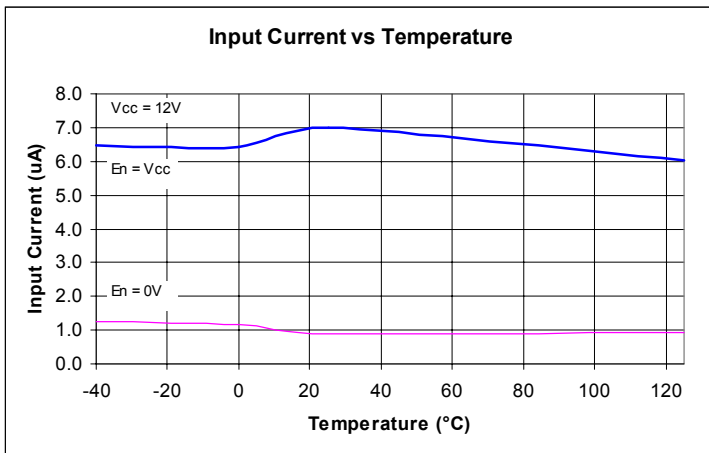
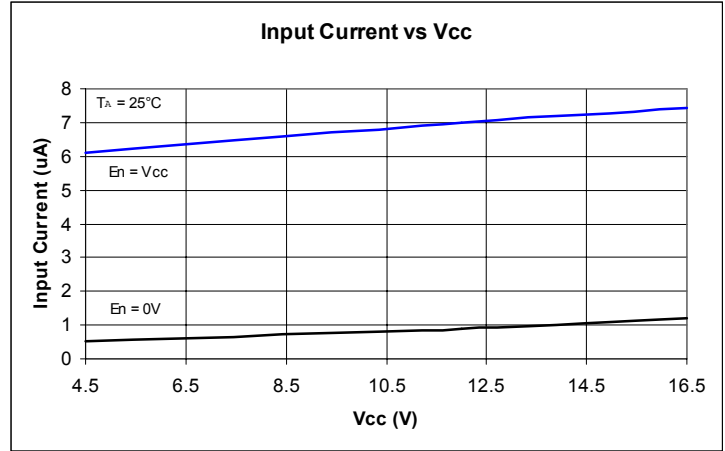
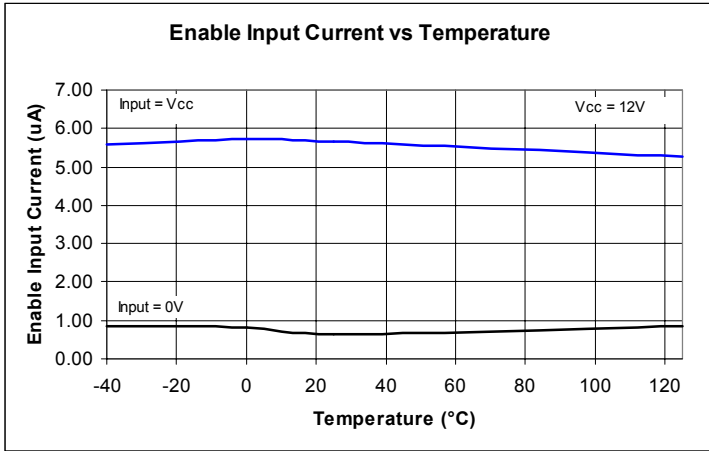

POWER MANAGEMENT

Outline Drawing - SOT-23-5

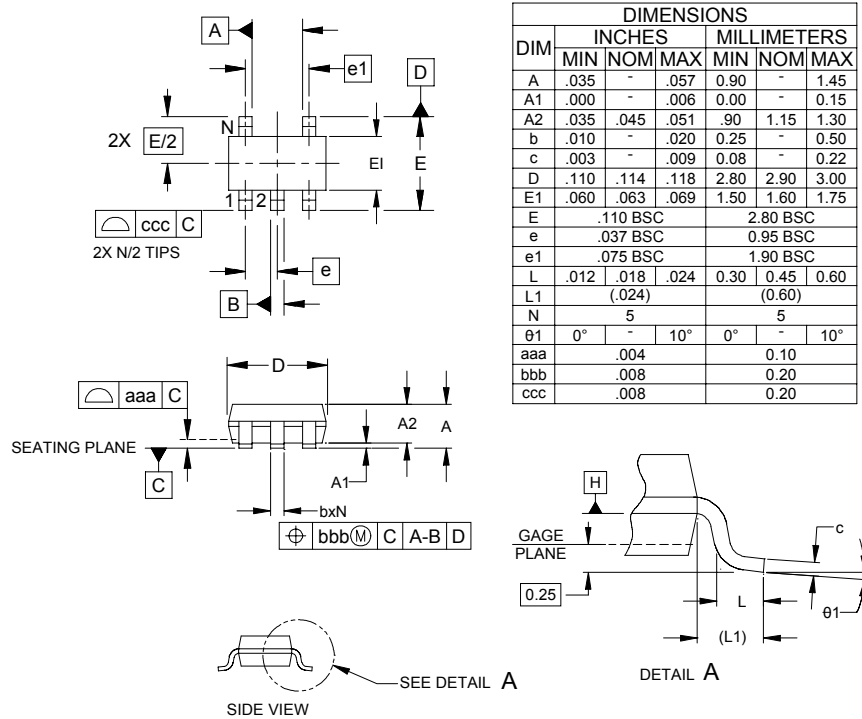

- NOTES:
1. CONTROLLING DIMENSIONS ARE IN MILLIMETERS (ANGLES IN DEGREES).
 2. DATUMS **-A-** AND **-B-** TO BE DETERMINED AT DATUM PLANE **-H-**
 3. DIMENSIONS "E1" AND "D" DO NOT INCLUDE MOLD FLASH, PROTRUSIONS OR GATE BURRS.

Land Pattern - SOT-23-5

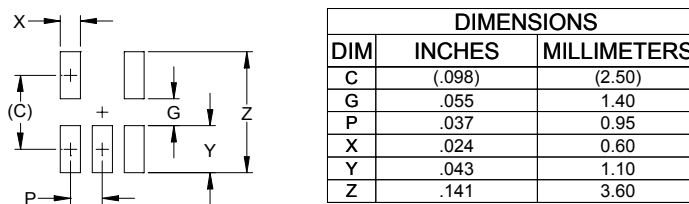

- NOTES:
1. THIS LAND PATTERN IS FOR REFERENCE PURPOSES ONLY. CONSULT YOUR MANUFACTURING GROUP TO ENSURE YOUR COMPANY'S MANUFACTURING GUIDELINES ARE MET.

Contact Information

Semtech Corporation
 Power Management Products Division
 200 Flynn Road, Camarillo, CA 93012
 Phone: (805)498-2111 FAX (805)498-3804