



# GS2004HE-A U

## SURFACE MOUNT RECTIFIER

**VOLTAGE** 400 Volt **CURRENT** 2 Ampere

### FEATURES

- For surface mounted applications in order to optimize board space
- Low profile package
- Ideal for automated placement
- Glass Passivated Chip Junction
- AEC-Q101 qualified
- Lead free in compliance with EU RoHS 2.0
- Green molding compound as per IEC 61249 standard

### MECHANICAL DATA

- Case: SOD-123HE, Molded plastic over passivated junction
- Terminals: Solder plated, solderable per MIL-STD-750, Method 2026
- Approx. Weight: 0.0006 ounces, 0.0184 grams
- Standard Packaging : 8mm tape (EIA-481)
- Polarity : Color band denotes cathode end

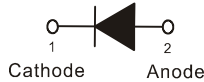
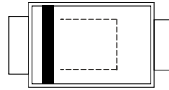

### SOD-123HE

Unit : inch(mm)

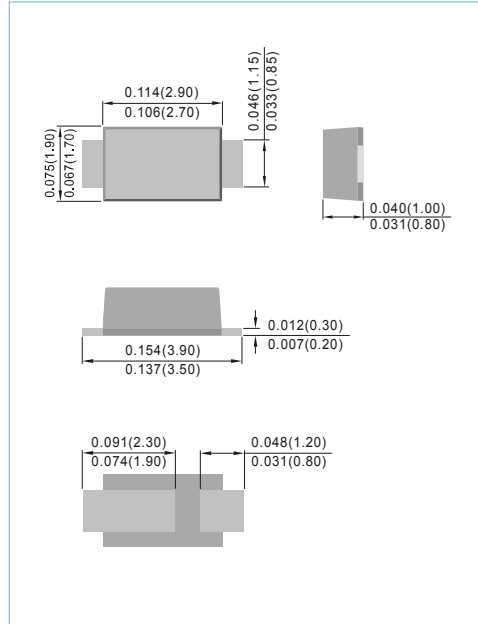

## MAXIMUM RATINGS AND ELECTRICAL CHARACTERISTICS

Ratings at 25°C ambient temperature unless otherwise specified.

PARAMETER	SYMBOL	VALUE	UNITS
Marking Code	-	4H	-
Maximum Recurrent Peak Reverse Voltage	$V_{RRM}$	400	V
Maximum RMS Voltage	$V_{RMS}$	280	V
Maximum DC Blocking Voltage	$V_{DC}$	400	V
Maximum Average Forward Current at $T_L=100\text{ }^\circ\text{C}$	$I_{F(AV)}$	2.0	A
Peak Forward Surge Current : 8.3ms single half sine-wave superimposed on rated load	$I_{FSM}$	50	A
Maximum Forward Voltage at 2.0A	$V_F$	1.1	V
Maximum DC Reverse Current at Rated DC Blocking Voltage	$I_R$	$T_J=25^\circ\text{C}$ 50 $T_J=125^\circ\text{C}$	$\mu\text{A}$
Typical Junction capacitance (Note 1)	$C_J$	12	pF
Typical Thermal Resistance (Note 2)	$R_{\theta JL}$	10	$^\circ\text{C} / \text{W}$
Operating and Storage Temperature Range	$T_J, T_{STG}$	-55 to +150	$^\circ\text{C}$

NOTES :

1. Measured at 1 MHz and applied  $V_r = 4.0$  volts.
2. 8.0 mm<sup>2</sup> ( .013mm thick ) land areas.



# GS2004HE-A U

## RATING AND CHARACTERISTIC CURVES

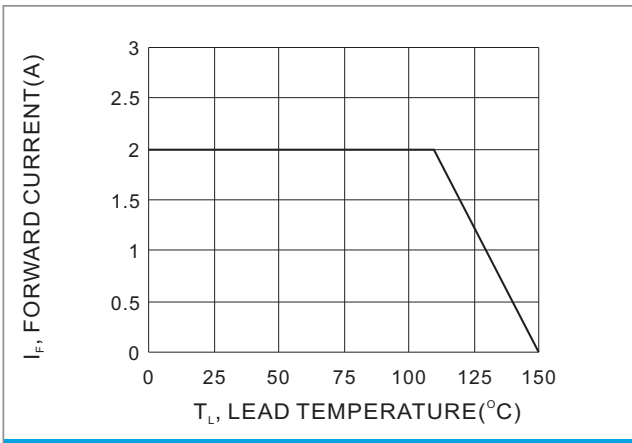

FIG.1 FORWARD CURRENT DERATING CURVE

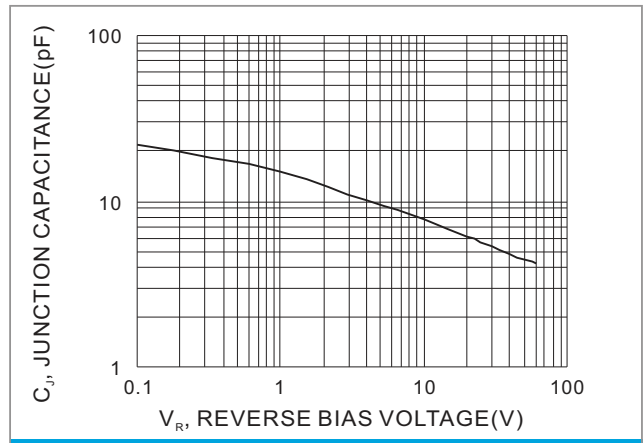

FIG.2 TYPICAL JUNCTION CAPACITANCE

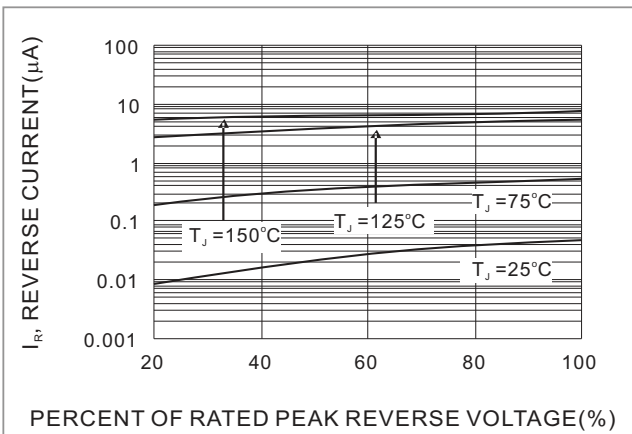

FIG.3 TYPICAL REVERSE CHARACTERISTICS

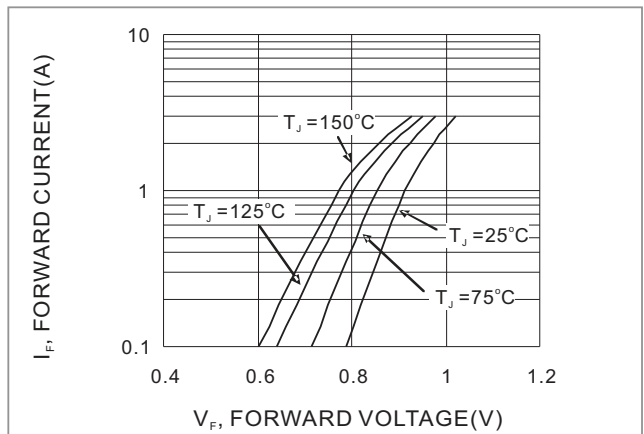

FIG.4 TYPICAL FORWARD CHARACTERISTICS



# GS2004HE-AU

## MOUNTING PAD LAYOUT

**SOD-123HE** Unit : inch(mm)

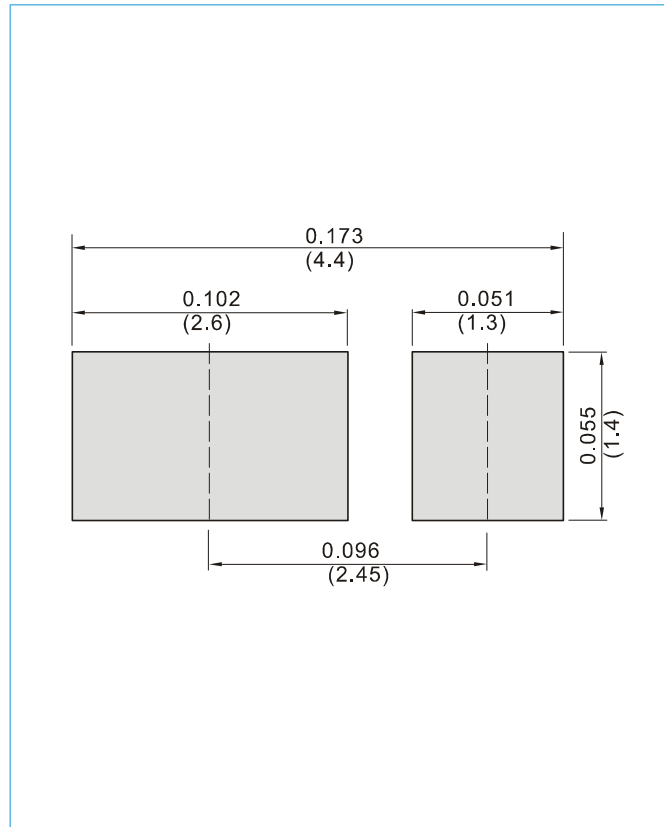

## ORDER INFORMATION

- Packing information  
T/R - 10K per 13" plastic Reel  
T/R - 3K per 7" plastic Reel



# GS2004HE-AU

## Part No\_packing code\_Version

GS2004HE-AU\_R1\_000A1

GS2004HE-AU\_R2\_000A1

For example :

**RB500V-40\_R2\_00001**



Packing Code <b>XX</b>				Version Code <b>XXXXX</b>		
Packing type	1 <sup>st</sup> Code	Packing size code	2 <sup>nd</sup> Code	HF or RoHS	1 <sup>st</sup> Code	2 <sup>nd</sup> ~5 <sup>th</sup> Code
Tape and Ammunition Box (T/B)	<b>A</b>	N/A	<b>0</b>	<b>HF</b>	<b>0</b>	serial number
Tape and Reel (T/R)	<b>R</b>	7"	<b>1</b>	<b>RoHS</b>	<b>1</b>	serial number
Bulk Packing (B/P)	<b>B</b>	13"	<b>2</b>			
Tube Packing (T/P)	<b>T</b>	26mm	<b>X</b>			
Tape and Reel (Right Oriented) (TRR)	<b>S</b>	52mm	<b>Y</b>			
Tape and Reel (Left Oriented) (TRL)	<b>L</b>	PANASERT T/B CATHODE UP (PBCU)	<b>U</b>			
FORMING	<b>F</b>	PANASERT T/B CATHODE DOWN (PBCD)	<b>D</b>			



## GS2004HE-A U

---

### Disclaimer

- Reproducing and modifying information of the document is prohibited without permission from Panjit International Inc..
- Panjit International Inc. reserves the rights to make changes of the content herein the document anytime without notification. Please refer to our website for the latest document.
- Panjit International Inc. disclaims any and all liability arising out of the application or use of any product including damages incidentally and consequentially occurred.
- Panjit International Inc. does not assume any and all implied warranties, including warranties of fitness for particular purpose, non-infringement and merchantability.
- Applications shown on the herein document are examples of standard use and operation. Customers are responsible in comprehending the suitable use in particular applications. Panjit International Inc. makes no representation or warranty that such applications will be suitable for the specified use without further testing or modification.
- The products shown herein are not designed and authorized for equipments relating to human life and for any applications concerning life-saving or life-sustaining, such as medical instruments, aerospace machinery et cetera. Customers using or selling these products for use in such applications do so at their own risk and agree to fully indemnify Panjit International Inc. for any damages resulting from such improper use or sale.
- Since Panjit uses lot number as the tracking base, please provide the lot number for tracking when complaining.