

---

# NI-9215

# Specifications

---

2022-10-06



# Contents

NI 9215.....	3
NI 9215 Specifications.....	8

# NI 9215

	<ul style="list-style-type: none"> <li>▪ BNC, screw terminal, or spring terminal connectivity</li> <li>▪ 250 V RMS, CAT II, channel-to-earth isolation (screw terminal); 60 V DC, CAT I, channel-to-earth isolation (BNC)</li> </ul>
---	--

The NI-9215 is an analog input module for use with NI CompactDAQ and CompactRIO systems. The NI-9215 includes four simultaneously sampled analog input channels and successive approximation register (SAR) 16-bit analog-to-digital converters (ADCs). The NI-9215 contains NIST-traceable calibration, a channel-to-earth ground double isolation barrier for safety and noise immunity, and high common-mode voltage range.

 <p>Kit Contents</p>	<ul style="list-style-type: none"> <li>• NI 9215</li> <li>• NI 9215 Getting Started Guide</li> </ul>
 <p>Accessories</p>	<ul style="list-style-type: none"> <li>• NI 9927 Backshell Connector Kit (Screw Terminal)</li> <li>• NI 9981 Backshell Connector Kit (Spring Terminal)</li> </ul>

C SERIES ANALOG INPUT MODULE COMPARISON						
Product Name	Signal Levels	Channels	Sample Rate	Simultaneous	Resolution	Connectivity
NI 9201	$\pm 10$ V	8 Single-Ended	500 kS/s	No	12-Bit	Screw-Terminal, Spring-Terminal, DSUB
NI 9205	$\pm 200$ mV, $\pm 1$ V, $\pm 5$ V, $\pm 10$ V	32 Single-Ended, 16 differential	250 kS/s	No	16-Bit	Spring-Terminal, DSUB
NI 9206	$\pm 200$ mV, $\pm 1$ V, $\pm 5$ V, $\pm 10$ V	32 Single-Ended, 16 Differential	250 kS/s	No	16-Bit	Spring-Terminal
NI 9207	$\pm 10$ V, $\pm 20$ mA	8 Differential, 8 Current	500 S/s	No	24-Bit	Spring-Terminal, DSUB
NI 9209	$\pm 10$ V	32 Single-Ended, 16 Differential	500 S/s	No	24-Bit	Spring-Terminal, DSUB
NI 9215	$\pm 10$ V	4 Differential	100 kS/s/ch	Yes	16-Bit	Screw-Terminal, Spring-Terminal, BNC
NI 9220	$\pm 10$ V	16 Differential	100 kS/s/ch	Yes	16-Bit	Spring-Terminal, DSUB
NI 9221	$\pm 60$ V	8 Single-Ended	800 kS/s	No	12-Bit	Screw-Terminal, Spring-Terminal, DSUB
NI 9222	$\pm 10$ V	4 Differential	500 kS/s/ch	Yes	16-Bit	Screw-Terminal, BNC
NI 9223	$\pm 10$ V	4 Differential	1 MS/s/ch	Yes	16-Bit	Screw-Terminal, BNC

## NI C Series Overview



NI provides more than 100 C Series modules for measurement, control, and communication applications. C Series modules can connect to any sensor or bus and allow for high-accuracy measurements that meet the demands of advanced data acquisition and control applications.

- Measurement-specific signal conditioning that connects to an array of sensors and signals
- Isolation options such as bank-to-bank, channel-to-channel, and channel-to-earth ground

- -40 °C to 70 °C temperature range to meet a variety of application and environmental needs
- Hot-swappable

The majority of C Series modules are supported in both CompactRIO and CompactDAQ platforms and you can move modules from one platform to the other with no modification.

## CompactRIO



CompactRIO combines an open-embedded architecture with small size, extreme ruggedness, and C Series modules in a platform powered by the NI LabVIEW reconfigurable I/O (RIO) architecture. Each system contains an FPGA for custom timing, triggering, and processing with a wide array of available modular I/O to meet any embedded application requirement.

## CompactDAQ

CompactDAQ is a portable, rugged data acquisition platform that integrates connectivity, data acquisition, and signal conditioning into modular I/O for directly interfacing to any sensor or signal. Using CompactDAQ with LabVIEW, you can easily customize how you acquire, analyze, visualize, and manage your measurement data.



## Software

### LabVIEW Professional Development System for Windows



- Use advanced software tools for large project development
- Generate code automatically using DAQ Assistant and Instrument I/O Assistant
- Use advanced measurement analysis and digital signal processing
- Take advantage of open connectivity with DLLs, ActiveX, and .NET objects
- Build DLLs, executables, and MSI installers

### NI LabVIEW FPGA Module

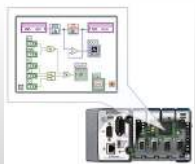

- Design FPGA applications for NI RIO hardware
- Program with the same graphical environment used for desktop and real-time applications
- Execute control algorithms with loop rates up to 300 MHz
- Implement custom timing and triggering logic, digital protocols, and DSP algorithms
- Incorporate existing HDL code and third-party IP including Xilinx IP generator functions
- Purchase as part of the LabVIEW Embedded Control and Monitoring Suite

### NI LabVIEW Real-Time Module



- Design deterministic real-time applications with LabVIEW graphical programming
- Download to dedicated NI or third-party hardware for reliable execution and a wide selection of I/O
- Take advantage of built-in PID control, signal processing, and analysis functions
- Automatically take advantage of multicore CPUs or set processor affinity manually
- Take advantage of real-time OS, development and debugging support, and board support

## NI LabVIEW Real-Time Module

- Purchase individually or as part of a LabVIEW suite

## NI-9215 Input Circuitry

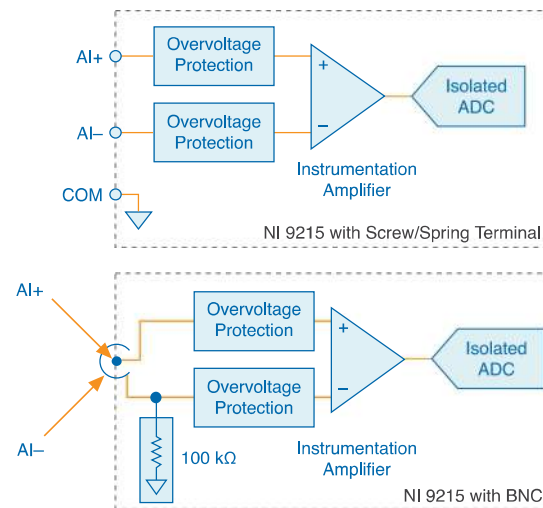

- Input signals on each channel are buffered, conditioned, and then sampled by an ADC.
- Each AI channel provides an independent track-and-hold amplifier, enabling you to sample all channels simultaneously.

# NI 9215 Specifications

The following specifications are typical for the range -40 °C to 70 °C unless otherwise noted.

**Caution** Do not operate the NI-9215 in a manner not specified in this document. Product misuse can result in a hazard. You can compromise the safety protection built into the product if the product is damaged in any way. If the product is damaged, return it to NI for repair.

## Input Characteristics

Number of channels	4 analog input channels
ADC resolution	16 bits
Type of ADC	Successive approximation register (SAR)
Input range	$\pm 10.0$ V

### Input Voltage Ranges

#### Measurement Voltage, AI+ to AI-

Minimum<sup>[1]</sup> (V)  $\pm 10.2$

Typical (V)  $\pm 10.4$

Maximum (V)  $\pm 10.6$

#### Maximum Voltage (Signal + Common Mode)

NI 9215 with screw terminal Each channel must remain within  $\pm 10.2$  V of common.



NI 9215 with spring terminal    Each channel must remain within  $\pm 10.2$  V of common.

NI 9215 with BNC                      All inputs must remain within 10.2 V of the average AI- inputs.

Overvoltage protection	$\pm 30$ V
------------------------	------------

**Conversion time**

Channel 0 only	4.4 $\mu$ s
Channels 0 and 1	6 $\mu$ s
Channels 0, 1, and 2	8 $\mu$ s
Channels 0, 1, 2, and 3	10 $\mu$ s

Measurement Conditions		Percent of Reading (Gain Error)	Percent of Range <sup>[2]</sup> (Offset Error)
Calibrated	Maximum (-40 °C to 70 °C)	0.2%	0.082%
	Typical (23 °C $\pm$ 5 °C)	0.02%	0.014%
Uncalibrated <sup>[3]</sup>	Maximum (-40 °C to 70 °C)	1.05%	0.82%
	Typical (23 °C $\pm$ 5 °C)	0.6%	0.38%

Table 1. Accuracy

<b>Stability</b>	
Gain drift	10 ppm/°C
Offset drift	60 $\mu$ V/°C
CMRR ( $f_{in}$ = 60 Hz)	73 dB min
Input bandwidth (-3 dB)	420 kHz minimum

**Input impedance****Resistance**

NI 9215 with screw terminal (AI-to-COM)	1 G $\Omega$
NI 9215 with spring terminal (AI-to-COM)	1 G $\Omega$
NI 9215 with BNC (Between any two AI- terminals)	200 k $\Omega$

Input bias current	10 nA
--------------------	-------

**Input noise**

RMS	1.2 LSB <sub>rms</sub>
Peak-to-peak	7 LSB

Crosstalk	-80 dB
-----------	--------

**Settling time (to 2 LSBs)****NI 9215 with screw terminal**

10 V step	10 $\mu$ s
-----------	------------

20 V step	15 $\mu$ s
-----------	------------

**NI 9215 with spring terminal**

10 V step	10 $\mu$ s
-----------	------------

20 V step	15 $\mu$ s
-----------	------------

**NI 9215 with BNC**

10 V step	25 $\mu$ s
20 V step	35 $\mu$ s
No missing codes	15 bits guaranteed
DNL	-1.9 to 2 LSB
INL	$\pm$ 6 LSB maximum
MTBF	1,167,174 hours at 25 °C; Bellcore Issue 6, Method 1, Case 3, Limited Part Stress Method

## Power Requirements

### Power consumption from chassis (full-scale input, 100 kS/s)

Active mode	560 mW maximum
Sleep mode	25 $\mu$ W maximum

### Thermal dissipation (at 70 °C)

Active mode	560 mW maximum
Sleep mode	25 $\mu$ W maximum

## Physical Characteristics

### Spring-terminal wiring

Gauge	0.2 mm <sup>2</sup> to 2.5 mm <sup>2</sup> (30 AWG to 12 AWG) copper conductor wire
-------	---

Wire strip length	10 mm (0.39 in.) of insulation stripped from the end
Temperature rating	90 °C, minimum
Wires per spring terminal	One wire per spring terminal; two wires per spring terminal using a 2-wire ferrule

**Connector securement**

Securement type	Screw flanges provided
Torque for screw flanges	0.2 N · m (1.80 lb · in.)

**Weight**

NI 9215 with screw terminal	150 g (5.3 oz)
NI 9215 with spring terminal	138 g (4.9 oz)
NI 9215 with BNC	173 g (6.1 oz)

## NI-9215 with Screw Terminal and NI-9215 with Spring Terminal Safety Voltages

Connect only voltages that are within the following limits.

Channel-to-COM	±30 V maximum
<b>Isolation</b>	
Channel-to-channel	None
<b>Channel-to-earth ground</b>	

Continuous	250 V RMS, Measurement Category II
Withstand	2,300 V RMS, verified by a 5 s dielectric withstand test

## NI-9215 with BNC Safety Voltages

Connect only voltages that are within the following limits.

AI+-to-AI-	±30 V maximum
<b>Isolation</b>	
Channel-to-channel	None
<b>Channel-to-earth ground</b>	
Continuous	60 V DC, Measurement Category I
Withstand	1,500 V RMS, verified by a 5 s dielectric withstand test

## Hazardous Locations

U.S. (UL)	Class I, Division 2, Groups A, B, C, D, T4; Class I, Zone 2, AEx nA IIC T4 Gc
Canada (C-UL)	Class I, Division 2, Groups A, B, C, D, T4; Class I, Zone 2, Ex nA IIC T4 Gc
Europe (ATEX) and International (IECEx)	Ex nA IIC T4 Gc

## Safety and Hazardous Locations Standards

This product is designed to meet the requirements of the following electrical equipment safety standards for measurement, control, and laboratory use:

- IEC 61010-1, EN 61010-1
- UL 61010-1, CSA 61010-1
- EN 60079-0:2012, EN 60079-15:2010
- IEC 60079-0: Ed 6, IEC 60079-15; Ed 4
- UL 60079-0; Ed 5, UL 60079-15; Ed 3
- CSA 60079-0:2011, CSA 60079-15:2012

**Note** For UL and other safety certifications, refer to the product label or the [Online Product Certification](#) section.

## Electromagnetic Compatibility

This product meets the requirements of the following EMC standards for electrical equipment for measurement, control, and laboratory use:

- EN 61326-1 (IEC 61326-1): Class A emissions; Industrial immunity
- EN 55011 (CISPR 11): Group 1, Class A emissions
- AS/NZS CISPR 11: Group 1, Class A emissions
- FCC 47 CFR Part 15B: Class A emissions
- ICES-001: Class A emissions

**Note** For EMC declarations and certifications, and additional information, refer to the [Online Product Certification](#) section.

## CE Compliance

This product meets the essential requirements of applicable European Directives, as follows:

- 2014/35/EU; Low-Voltage Directive (safety)
- 2014/30/EU; Electromagnetic Compatibility Directive (EMC)
- 94/9/EC; Potentially Explosive Atmospheres (ATEX)

## Product Certifications and Declarations

Refer to the product Declaration of Conformity (DoC) for additional regulatory compliance information. To obtain product certifications and the DoC for NI products, visit [ni.com/product-certifications](http://ni.com/product-certifications), search by model number, and click the appropriate link.

## Shock and Vibration

To meet these specifications, you must panel mount the system.

<b>Operating vibration</b>	
Random (IEC 60068-2-64)	5 g <sub>rms</sub> , 10 Hz to 500 Hz
Sinusoidal (IEC 60068-2-6)	5 g, 10 Hz to 500 Hz
Operating shock (IEC 60068-2-27)	30 g, 11 ms half sine; 50 g, 3 ms half sine; 18 shocks at 6 orientations

## Environmental

Refer to the manual for the chassis you are using for more information about meeting these specifications.

Operating temperature (IEC 60068-2-1, IEC 60068-2-2)	-40 °C to 70 °C
Storage temperature (IEC 60068-2-1, IEC 60068-2-2)	-40 °C to 85 °C
Ingress protection	IP40
Operating humidity (IEC 60068-2-78)	10% RH to 90% RH, noncondensing
Storage humidity (IEC 60068-2-78)	5% RH to 95% RH, noncondensing
Pollution Degree	2
Maximum altitude	2,000 m

Indoor use only.

## Environmental Management

NI is committed to designing and manufacturing products in an environmentally responsible manner. NI recognizes that eliminating certain hazardous substances from our products is beneficial to the environment and to NI customers.

For additional environmental information, refer to the **Engineering a Healthy Planet** web page at [ni.com/environment](http://ni.com/environment). This page contains the environmental regulations and directives with which NI complies, as well as other environmental information not included in this document.

## EU and UK Customers

-  **Waste Electrical and Electronic Equipment (WEEE)**—At the end of the product life cycle, all NI products must be disposed of according to local laws and regulations. For more information about how to recycle NI products in your region, visit [ni.com/environment/weee](http://ni.com/environment/weee).



## 电子信息产品污染控制管理办法（中国 RoHS）

-  中国 RoHS— NI 符合中国电子信息产品中限制使用某些有害物质指令(RoHS)。关于 NI 中国 RoHS 合规性信息，请登录 [ni.com/environment/rohs\\_china](http://ni.com/environment/rohs_china)。(For information about China RoHS compliance, go to [ni.com/environment/rohs\\_china](http://ni.com/environment/rohs_china).)

## Calibration

You can obtain the calibration certificate and information about calibration services for the NI 9215 at [ni.com/calibration](http://ni.com/calibration).

Calibration interval	1 year
----------------------	--------

<sup>1</sup> The minimum measurement voltage range is the largest voltage the NI-9215 is guaranteed to accurately measure.

<sup>2</sup> Range equals  $\pm 10.4$  V.

<sup>3</sup> Uncalibrated accuracy refers to the accuracy achieved when acquiring in raw or unscaled modes where the calibration constants stored in the module are not applied to the data.