

3-Phase Brushless Motor Pre-driver

BD63002AMUV

General Description

BD63002AMUV is pre-driver of 3-phase brushless motor. It generates a driving signal from the Hall sensor and drives PWM through the input control signal. Since there is a built-in booster circuit, Nch-Nch MOS transistors can be used on the external power transistor. In addition, the power supply can use 12V or 24V and it has various controls and protection functions built-in, making it useful for a variety of purposes. Because it adopts small packages, it can also be used on small diameter motors.

Features

- Built-in 120° Commutation Logic Circuit
- Driving with Nch-Nch MOS Transistors
- PWM Control Mode (Low Side Arm Switching)
- Built-in Power-saving Circuit
- Direction of Rotation Change Function
- Short Brake Function
- FG Output (Open drain)
- Built-in Protection Circuit for Current Limit, Thermal Shutdown, Under Voltage Lockout, Over Voltage Lockout, Motor Lock Protection

Applications

- OA Machines
- Other General Civil Equipment

Key Specifications

■ Power Supply Voltage Rating	33V
■ Operating Temperature Range	-40°C to +85°C
■ Stand-by Current	1.2mA(Max)
■ Range of In-phase Input Voltage for Hall Input	V _{REG} -1.7V(Max)
■ Current Limit Detect Voltage	0.2V±10%
■ UVLO Lockout Voltage	6.0V(Typ)
■ OVLO Lockout Voltage 1	16.0V(Typ)
■ OVLO Lockout Voltage 2	28.5V(Typ)

Package

VQFN028V5050

W(Typ) x D(Typ) x H(Max)

5.00mm x 5.00mm x 1.00mm

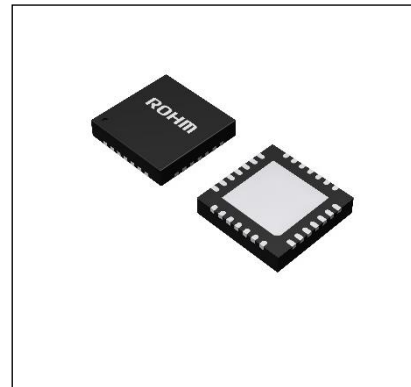

VQFN028V5050

Typical Application Circuit

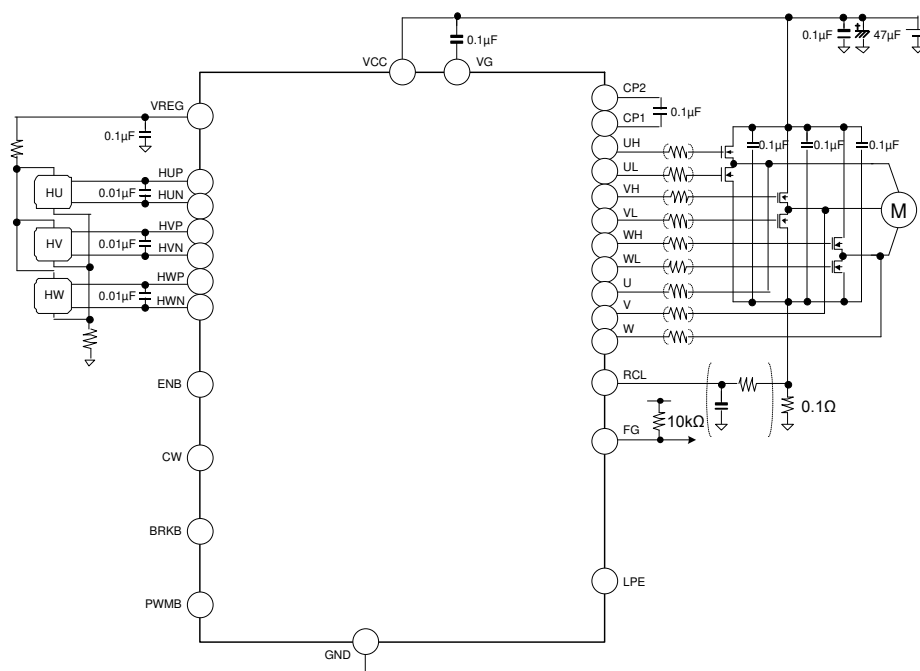

Figure 1. Application Circuit

○Product structure : Silicon monolithic integrated circuit ○This product is not designed protection against radioactive rays

Pin Configuration

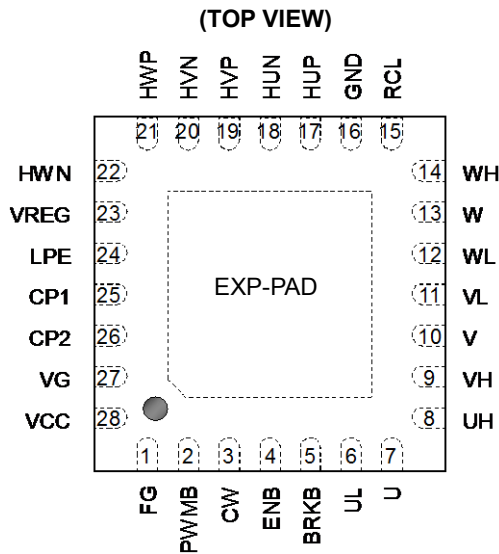

Figure 2. Pin Configuration

Block Diagram

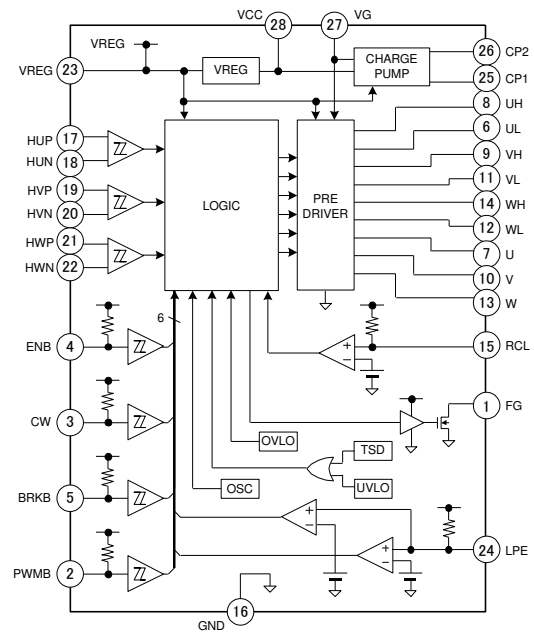

Figure 3. Block Diagram

Pin Description

Pin No.	Pin Name	Function	Pin No.	Pin Name	Function
1	FG	FG output	15	RCL	Detect voltage input for over current
2	PWMB	PWM input (negative logic)	16	GND	GND
3	CW	Changing Direction of rotation (H: CW, L: CCW)	17	HUP	U phase Hall input+
4	ENB	Enable (negative logic)	18	HUN	U phase Hall input-
5	BRKB	Brake input (negative logic)	19	HVP	V phase Hall input+
6	UL	U phase lower output	20	HVN	V phase Hall input-
7	U	U phase output feedback	21	HWP	W phase Hall input+
8	UH	U phase upper output	22	HWN	W phase Hall input-
9	VH	V phase upper output	23	VREG	VREG output (turn off at stand-by)
10	V	V phase output feedback	24	LPE	Setting about motor lock protection and OVLO (H/M/L input)
11	VL	V phase lower output	25	CP1	Charge pump setting 1
12	WL	W phase lower output	26	CP2	Charge pump setting 2
13	W	W phase output feedback	27	VG	Charge pump output
14	WH	W phase upper output	28	VCC	Power supply
-	EXP-PAD	The EXP-PAD of the center of product connects to GND.			

Description of Operation

Commutation logic (120° commutation)

Truth table

HU	HV	HW	CW (CW=H or OPEN)						FG
			UH	UL	VH	VL	WH	WL	
H	L	H	PWM	PWM ^(Note 1)	H	L	L	L	L
H	L	L	$\overline{\text{PWM}}$	PWM ^(Note 1)	L	L	H	L	L
H	H	L	L	L	$\overline{\text{PWM}}$	PWM ^(Note 1)	H	L	L
L	H	L	H	L	$\overline{\text{PWM}}$	PWM ^(Note 1)	L	L	Hi-z
L	H	H	H	L	L	L	PWM	PWM ^(Note 1)	Hi-z
L	L	H	L	L	H	L	PWM	PWM ^(Note 1)	Hi-z
H	H	H	L	L	L	L	L	L	L
L	L	L	L	L	L	L	L	L	Hi-z

HU	HV	HW	CCW (CW=L)						FG
			UH	UL	VH	VL	WH	WL	
H	L	H	H	L	PWM	PWM ^(Note 1)	L	L	L
H	L	L	H	L	L	L	$\overline{\text{PWM}}$	PWM ^(Note 1)	L
H	H	L	L	L	H	L	$\overline{\text{PWM}}$	PWM ^(Note 1)	L
L	H	L	$\overline{\text{PWM}}$	PWM ^(Note 1)	H	L	L	L	Hi-z
L	H	H	$\overline{\text{PWM}}$	PWM ^(Note 1)	L	L	H	L	Hi-z
L	L	H	L	L	$\overline{\text{PWM}}$	PWM ^(Note 1)	H	L	Hi-z
H	H	H	L	L	L	L	L	L	L
L	L	L	L	L	L	L	L	L	Hi-z

(Note 1) When PWMB=L, PWM="H". When PWMB=H, PWM="L"

Enable input pin (ENB)

Output of each phase can be set to ON/OFF (negative logic) through the ENB pin. When applied voltage is V_{ENB} or less, the motor is driven (enable). When applied voltage is V_{STBY} or more or the ENB pin is open, the motor stops (stand-by). Stand-by mode has precedence to other control input signal, VREG output will be OFF. In addition, the ENB pin is pulled up by internal power supply through a resistance of 100kΩ(Typ)±30kΩ.

ENB	Operation
H or OPEN	Stand-by
L	Enable

PWM input pin (PWMB)

Speed can be controlled by inputting PWM signal into the PWMB pin (negative logic). Synchronous rectifier PWM can be realized through lower switching. When PWMB="L", lower output that belongs to Hall input logic is "H". When PWMB="H" or OPEN, lower output is "L". When PWMB="H" or OPEN status is detected 104μs(Typ), the synchronous rectifier will be OFF. Synchronous rectifier will be ON through falling edges of subsequent PWMB. Additionally, the PWMB pin is pulled up by VREG through a resistance of 100kΩ(Typ)±30kΩ.

PWMB	Low side output
H or OPEN	L
L	H

Description of Operation – continued

Brake input pin (BRKB)

Motor rotation can be quickly stopped by the BRKB pin (negative logic). When BRKB="L", lower output become all "H" and operates short brake "H". When BRKB="H" or OPEN, then short brake operation will be released. What is more, the BRKB pin is pulled up by VREG through a resistance of 100kΩ(Typ)±30kΩ.

BRKB	Operation
H or OPEN	Normal
L	Short brake

CW/CCW input pin (CW)

Rotation direction can be switched with the CW pin. When CW="H" or OPEN, the direction is CW. When CW="L", the direction will be CCW. Though we do not recommend switching rotation direction when motor is rotating. If rotation direction is switched when rotating, after the short brake operation until the hall frequency is 40Hz or less, the direction of rotation is switched. And the CW pin is pulled up by VREG through a resistance of 100kΩ(Typ)±30kΩ.

CW	Direction
H or OPEN	CW
L	CCW

FG output

FG output is shaped Hall U phase signal and output through the FG pin. It is not output in stand-by mode. In addition, because the FG pin is output from open drain, use resistance of about 10kΩ to 100kΩ to pulled up from outside.

Hall input

Hall input amplifier is designed with hysteresis (±15mV(Typ)) in order to prevent incorrect action due to noise inside. So set bias current for Hall element to make amplitude of Hall input voltage of minimum input voltage (V_{HALLMIN}) or more. Here, we recommend you to connect the ceramic capacitor with about 100pF to 0.01μF between differential input pins of Hall amplifier. What is more, because the in-phase input voltage range (V_{HALLCM}, 0V to V_{REG}-1.7V(Typ)) is designed for Hall input amplifier, so when bias to Hall element, set within this range. When all Hall inputs become "H" or "L", all driver outputs will be "L" by the hall input abnormal detection circuit.

Booster circuit

There is built-in booster circuit used to drive upper Nch MOS transistor. The VG pins can produce a boost voltage (the VCC voltage + 7V(Typ)) through connecting capacitors between CP1-CP2 and between VG-VCC. We recommend connected condensers to be 0.1μF or more. In addition, because there is built-in protection circuit for insufficient booster, when VG voltage is V_{GUVON} (V_{CC}+4V (Typ)) or less, all driver outputs will be "L".

Current limit circuit (CL circuit)

Output current limit (Current Limit: CL) circuit can be formed by connecting a low resistor used for detecting current between the RCL pin and the GND pin. When RCL voltage is detected 0.2V(Typ) or more, all lower output will be "L". It returns by itself after a set amount of time (32μs(Typ)). This operation does not synchronize with the operation that PWM signal is input into the PWMB pin. In addition, in order to avoid misdetection of output current due to RCL noise, the IC sets up the noise-masking period (1μs to 2μs(Typ)). During noise-masking period, the current detection is disabled.

Thermal Shutdown circuit (TSD circuit)

When chip temperature of driver IC rises and exceeds the set temperature (175°C(Typ)), the thermal Shutdown circuit (Thermal Shutdown: TSD) begins working. At this time, all driver outputs will be "L". In addition, the TSD circuit is designed with hysteresis (25°C(Typ)), therefore, when the chip temperature drops, it will return to normal working condition. Moreover, the purpose of the TSD circuit is to protect driver IC from thermal breakdown, therefore, temperature of this circuit will be over working temperature when it is started up. Thus, thermal design should have sufficient margin, so do not take continuous use and operation of the circuit as precondition.

Under voltage lockout circuit (UVLO circuit)

There is a built-in under voltage lockout circuit (Under Voltage Lockout: UVLO circuit) used to ensure the lowest power supply voltage for drive IC to work and to prevent error operation of IC. When VCC voltage declined to V_{UVL} (6V (Typ)), all of the driver outputs should be "L". At the same time, UVLO circuit is designed with hysteresis (1V(Typ)), so when VCC voltage reaches V_{UVH} (7V(Typ)) or more, it will enter normal working condition.

Description of Operation – continued

Over voltage lockout circuit (OVLO circuit)

There is built-in over voltage lockout circuit (Over Voltage Lockout: OVLO circuit) used to restrain rise of VCC voltage when motor decelerating. When the LPE pin is at "M" and VCC voltage is V_{OVH1} (16V(Typ)) or more, and when the LPE pin is at "H" or "M" and VCC voltage is V_{OVH2} (28.5V(Typ)) or more, a certain time (4ms(Typ)) of short brake action will be conducted. What is more, because OVLO circuit is designed with hysteresis (1V(Typ)), therefore, when V_{OVH1} is V_{OVL1} (15V(Typ)) or less and when V_{OVH2} is V_{OVL2} (27.5V(Typ)) or less, it can return to normal working condition after a certain time of short brake action.

Motor Lock Protection circuit (MLP circuit)

There is built-in motor lock protection circuit (Motor Lock Protection: MLP), ON/OFF of MLP circuit and OVLO threshold can be set by the LPE pin. Monitor Hall signals, when the LPE = "H" or "M", if Hall signal logic does not change 1.1s(Typ) or more, driver outputs will all be latched as "L". Latch can be released via standby status or through switching BRKB/CW logic. Moreover, when PWMB = "H" or OPEN state is detected for about 15ms, latch can be released by falling edges of subsequent PWMB. However, in case of LPE = "L", and when short brake action (including switching rotation direction) enables or TSD circuit works, MLP circuit does not work. And the LPE pin is pulled up by VREG through a resistance of $30k\Omega(Typ)\pm 9k\Omega$.

LPE	Monitoring time	OVLO threshold
H or OPEN	1.1s(Typ) \pm 30%	V_{OVH2} , V_{OVL2}
M	1.1s(Typ) \pm 30%	V_{OVH1} , V_{OVL1}
L	Disable	V_{OVH2} , V_{OVL2}

Pre-driver output

Driving signal is output to external output power transistor through drive signal generated from internal logic. Driving voltage of upper gate is VG voltage ($V_{CC}+7V(Typ)$) and driving voltage of lower gate is VREG voltage (5V(Typ)). In addition, a dead time (1 μ s(Typ) \pm 30%) is designed between driving signals of upper gate and lower gate in order to prevent upper and lower FET from being set to ON synchronously when PWM is rectified synchronously. Due to the influence of the motor's counter electromotive force, the output feedback pin (U, V, W) might swing under GND potential. By this swing, malfunctions and destruction can be caused by application. When negative potential exceeds -1.5V (Typ), 510 Ω or less of resistance can be inserted to prevent malfunction and destruction.

Control signal sequence

Though we recommend you input control signals of the ENB, CW, PWMB, BRKB and LPE pins after inputting VCC, if input control signals before inputting VCC, there won't be any problem. If the LPE pin is set to "H" or "M" when being started, be informed that if motor rotation cannot be detected (edge of FG signal cannot be input) within the set time, then the MLP circuit starts and motor fails to start. Moreover, the order of priority is set to control signal and IC internal signal. Refer to the following table.

Priority of control signal

Priority	Input / Internal signals
1 st	ENB, UVLO
2 nd	BRKB $\uparrow\downarrow$ (Note 2), CW $\uparrow\downarrow$ (Note 2), PWMB \downarrow (Note 2)
3 rd	TSD, MLP, HALLERR
4 th	OVLO
5 th	VG_UVLO
6 th	BRKB
7 th	CL
8 th	PWMB, CW

(Note 2) $\uparrow\downarrow$ means rising and falling edges of signal.
For signal name, see [State Transition Diagram](#).

Description of Operation – continued

IC back metal

The back side metal is shorted with IC chip's back side and becomes the GND potential, so there is the danger of malfunction and destruction if shorted with potentials other than GND. Therefore, please absolutely do not design patterns other than GND through the IC's back side.

Operation Under Strong Electromagnetic Field

The IC is not designed for using in the presence of strong electromagnetic field. Be sure to confirm that no malfunction is found when using the IC in a strong electromagnetic field.

Absolute Maximum Ratings (Ta=25°C)

Item	Symbol	Limit	Unit
Power Supply Voltage	V _{CC}	-0.3 to +33.0 ^(Note 3)	V
VG Voltage	V _G	-0.3 to +38.0 ^(Note 4)	V
Output Voltage of Pre-driver	V _(UH, VH, WH)	-0.3 to +38.0	V
	V _(UL, VL, WL)	-0.3 to +7.0	V
FG Voltage	V _{FG}	-0.3 to +7.0	V
RCL Voltage	V _{RCL}	-0.3 to +5.5	V
Voltage of Input of Control and Hall pins	V _{I/O}	-0.3 to +5.5	V
Output Current of Pre-driver(DC)	I _{OMAX(OUT)}	±15 ^(Note 4)	mA
FG Output Current	I _{FG}	5 ^(Note 4)	mA
VREG Output Current	I _{VREG}	-30 ^(Note 4)	mA
Storage Temperature Range	T _{stg}	-55 to +150	°C
Maximum Junction Temperature	T _{jmax}	150	°C

Caution 1: Operating the IC over the absolute maximum ratings may damage the IC. The damage can either be a short circuit between pins or an open circuit between pins and the internal circuitry. Therefore, it is important to consider circuit protection measures, such as adding a fuse, in case the IC is operated over the absolute maximum ratings.

Caution 2: Should by any chance the maximum junction temperature rating be exceeded the rise in temperature of the chip may result in deterioration of the properties of the chip. In case of exceeding this absolute maximum rating, design a PCB with thermal resistance taken into consideration by increasing board size and copper area so as not to exceed the maximum junction temperature rating.

(Note 3) Do not exceed T_{jmax}=150°C. VCC range is -0.3V to +30.0V, when the boost circuit is operating.

(Note 4) Do not exceed T_{jmax}=150°C.

Thermal Resistance^(Note 5)

Parameter	Symbol	Thermal Resistance (Typ)		Unit
		1s ^(Note 7)	2s2p ^(Note 8)	
VQFN028V5050				
Junction to Ambient	θ_{JA}	128.5	31.5	°C/W
Junction to Top Characterization Parameter ^(Note 6)	Ψ_{JT}	12	9	°C/W

(Note 5) Based on JESD51-2A(Still-Air).

(Note 6) The thermal characterization parameter to report the difference between junction temperature and the temperature at the top center of the outside surface of the component package.

(Note 7) Using a PCB board based on JESD51-3.

(Note 8) Using a PCB board based on JESD51-5, 7.

Layer Number of Measurement Board	Material	Board Size
Single	FR-4	114.3mm x 76.2mm x 1.57mmt

Top	
Copper Pattern	Thickness
Footprints and Traces	70 μ m

Layer Number of Measurement Board	Material	Board Size	Thermal Via ^(Note 9)	
			Pitch	Diameter
4 Layers	FR-4	114.3mm x 76.2mm x 1.6mmt	1.20mm	Φ 0.30mm

Top		2 Internal Layers		Bottom	
Copper Pattern	Thickness	Copper Pattern	Thickness	Copper Pattern	Thickness
Footprints and Traces	70 μ m	74.2mm x 74.2mm	35 μ m	74.2mm x 74.2mm	70 μ m

(Note 9) This thermal via connects with the copper pattern of all layers.

Recommended Operating Condition

Item	Symbol	Range			Unit
		Min	Typ	Max	
Power Supply Voltage	V _{CC}	8.0	24.0	26.4	V
Operating Temperature	T _{opr}	-40	+25	+85	°C

Electrical Characteristic (Unless otherwise specified Ta=25°C, V_{CC}=24V)

Item	Symbol	Limit			Unit	Condition
		Min	Typ	Max		
[Whole]						
Circuit Current	I _{CC}	-	2.5	5.0	mA	V _{ENB} =0V
Stand-by Current	I _{STBY}	-	0.6	1.2	mA	ENB=OPEN
VREG Voltage	V _{REG}	4.5	5.0	5.5	V	I _{VREG} =-10mA
[Booster circuit]						
VG Voltage	V _G	V _{CC} +6	V _{CC} +7	V _{CC} +8	V	
VG UVLO Voltage	V _{GUVON}	V _{CC} +3	V _{CC} +4	V _{CC} +5	V	
[Driver output]						
High Side Output Voltage H	V _{OHH}	V _G -0.6	V _G -0.2	V _G	V	I _{HSOURCE} =-5mA
High Side Output Voltage L	V _{OHL}	0	0.2	0.6	V	I _{HSINK} =5mA
Low Side Output Voltage H	V _{OLH}	V _{REG} -0.4	V _{REG} -0.2	V _{REG}	V	I _{LSOURCE} =-5mA
Low Side Output Voltage L	V _{OLL}	0	0.2	0.6	V	I _{LSINK} =5mA
Source Current of High Side	I _{HSOURCE}	100	130	-	mA	I _{HSOURCE} pulse width ≤1μs
Sink Current of High Side	I _{HSINK}	50	65	-	mA	I _{HSINK} pulse width ≤1μs
Source Current of Low Side	I _{LSOURCE}	50	65	-	mA	I _{LSOURCE} pulse width ≤1μs
Sink Current of Low Side	I _{LSINK}	100	130	-	mA	I _{LSINK} pulse width ≤1μs
Dead Time	t _{DT}	0.7	1.0	1.3	μs	
[Hall input]						
Input Bias Current	I _{HALL}	-2.0	-0.1	+2.0	μA	V _{IN} =0V
Range of In-phase Input Voltage	V _{HALLCM}	0	-	V _{REG} -1.7	V	
Minimum Input Voltage	V _{HALLMIN}	50	-	-	mVp-p	
HYS Level +	V _{HALLHY+}	5	15	25	mV	
HYS Level -	V _{HALLHY-}	-25	-15	-5	mV	
[Input of control:ENB]						
Input Current	I _{ENB}	-75	-45	-25	μA	V _{ENB} =0V
Standby Voltage	V _{STBY}	2.0	-	5.5	V	
Enable Voltage	V _{ENB}	0	-	0.8	V	
[Input of control:PWMB, CW, BRKB]						
Input Current	I _{IN}	-80	-50	-30	μA	V _{IN} =0V
Input Voltage H	V _{INH}	2.0	-	5.5	V	
Input Voltage L	V _{INL}	0	-	0.8	V	
Minimum Input Pulse Width	t _{PLSMIN}	1	-	-	ms	CW, BRKB
Range of Input Frequency	f _{PWM}	10	-	50	kHz	PWMB
[Input of control:LPE]						
Input Current	I _{LPE}	-267	-167	-100	μA	V _{LPE} =0V
Input Voltage H	V _{LPH}	0.8 x V _{REG}	-	V _{REG}	V	
Input Voltage M	V _{LPM}	0.4 x V _{REG}	-	0.6 x V _{REG}	V	
Input Voltage L	V _{LPL}	0	-	0.2 x V _{REG}	V	
[FG output]						
Output Voltage L	V _{FGOL}	0	0.1	0.3	V	I _{FG} =2mA
Leak Current	I _{FGLEAK}	-	0	1	μA	V _{FG} =5V
[Current limit]						
Detect Voltage	V _{CL}	0.18	0.20	0.22	V	
Input Bias Current	I _{RCL}	-32	-20	-12	μA	V _{RCL} =0V
Range of Input Voltage	V _{RCL}	-0.3	-	+1.0	V	

Electrical Characteristic (Unless otherwise specified Ta=25°C, V_{CC}=24V) - continued

Item	Symbol	Limit			Unit	Condition
		Min	Typ	Max		
[UVLO]						
Release Voltage	V _{UVH}	6.5	7.0	7.5	V	
Lockout Voltage	V _{UVL}	5.5	6.0	6.5	V	
[OVLO]						
Release Voltage1	V _{OVL1}	14.0	15.0	16.0	V	LPE="M"
Lockout Voltage1	V _{OVH1}	15.0	16.0	17.0	V	LPE="M"
Release Voltage2	V _{OVL2}	26.5	27.5	28.5	V	LPE="H" or "L"
Lockout Voltage2	V _{OVH2}	27.5	28.5	29.5	V	LPE="H" or "L"
[MLP]						
Motor Lock Protection Detect Time	t _{LPE}	0.77	1.10	1.43	s	LPE="H" or "M"

Reference Data ^(Note 10) (Unless otherwise specified V_{CC}=24V)

Item	Symbol	Reference			Unit	Condition
		Min	Typ	Max		
[Current limit]						
Mask Time	t _{CLMASK}	0.7	-	2.6	μs	Ta=25°C
[Protect]						
TSD ON Temperature	T _{TSDON}	150	175	200	°C	Junction temperature (Tj)
TSD Hysteresis	T _{TSDHYS}	15	25	35	°C	Junction temperature (Tj)

(Note 10) Not 100% tested.

Typical Performance Curves (Reference Data)

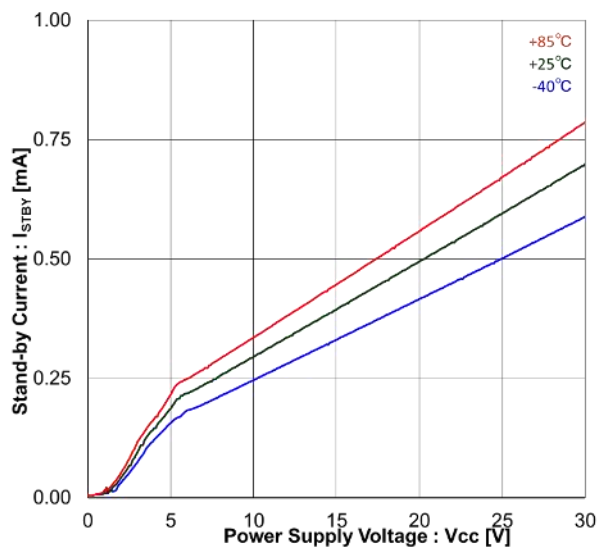

Figure 4. Stand-by Current vs Power Supply Voltage

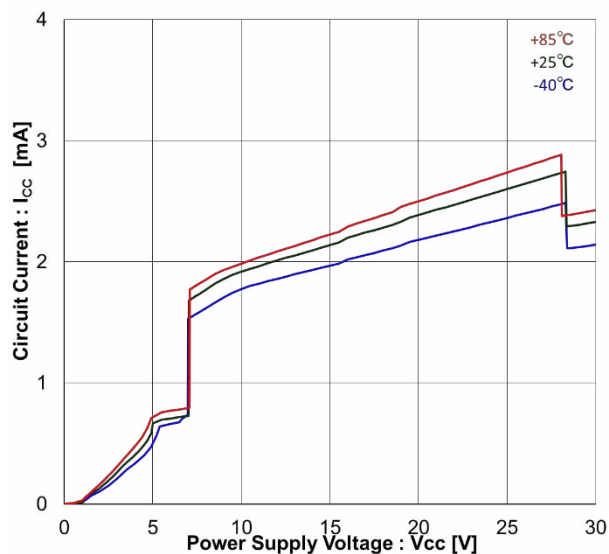

Figure 5. Circuit Current vs Power Supply Voltage

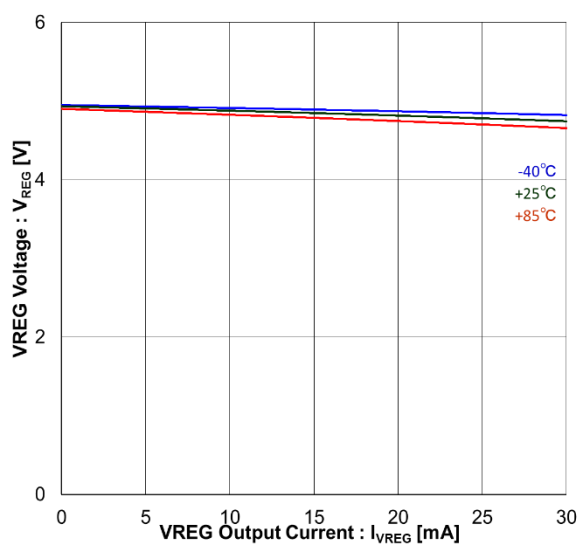

Figure 6. VREG Voltage vs VREG Output Current

Typical Performance Curves (Reference Data) – continued

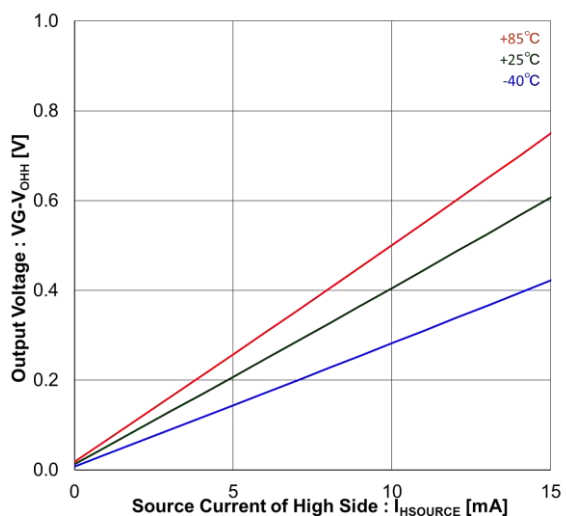

Figure 7. Output Voltage vs Source Current of High Side (High side Output voltage H)

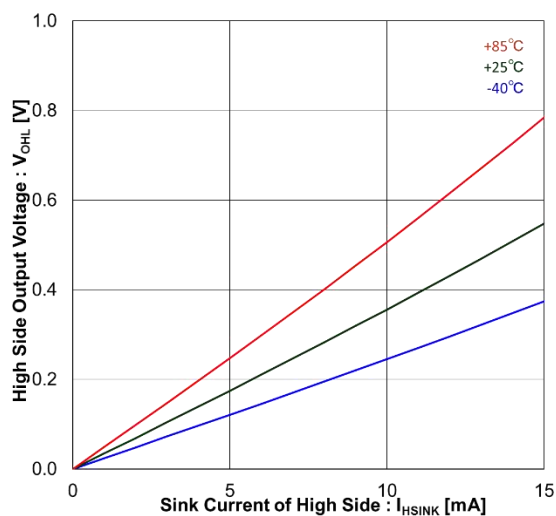

Figure 8. High Side Output Voltage L vs Sink Current of High Side (High side Output voltage L)

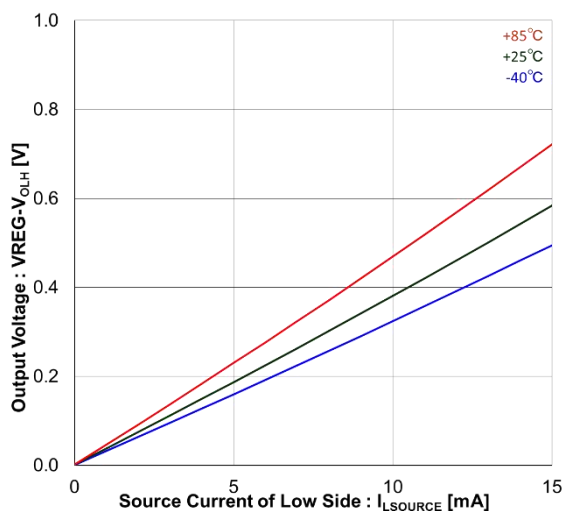

Figure 9. Output Voltage vs Source Current of Low Side (Low side Output voltage H)

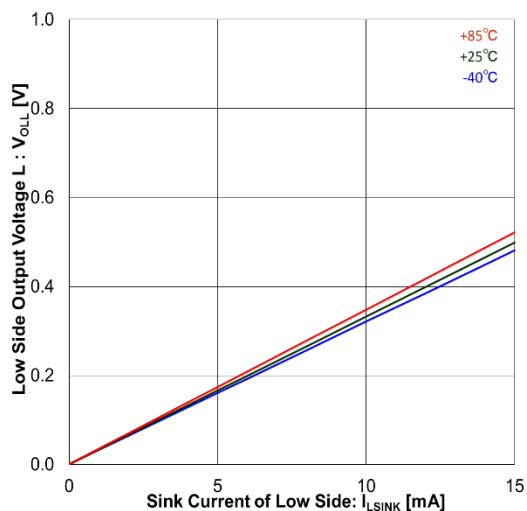

Figure 10. Low Side Output Voltage L vs Sink Current of Low Side (Low side Output voltage L)

Typical Performance Curves (Reference Data) – continued

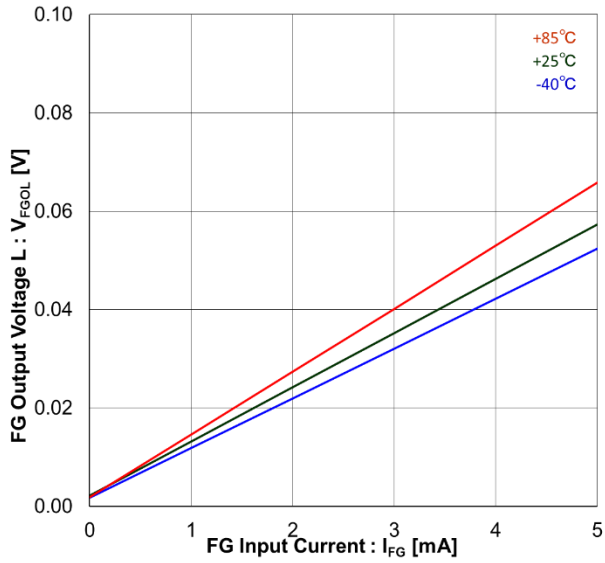

Figure 11. FG Output Voltage L vs FG Input Current

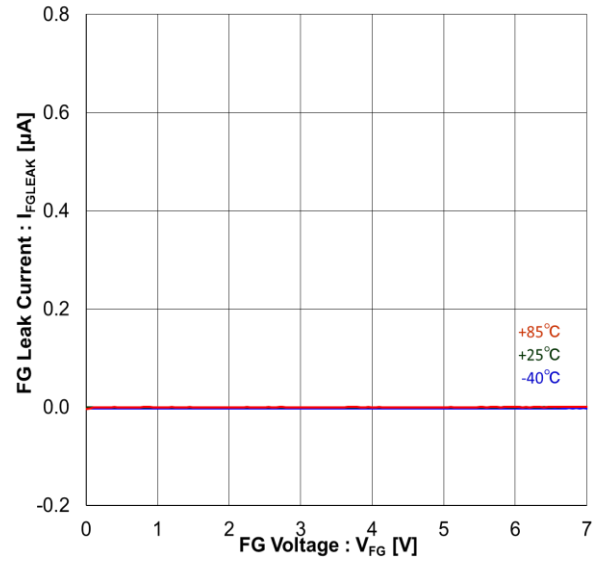

Figure 12. FG Leak Current vs FG Voltage

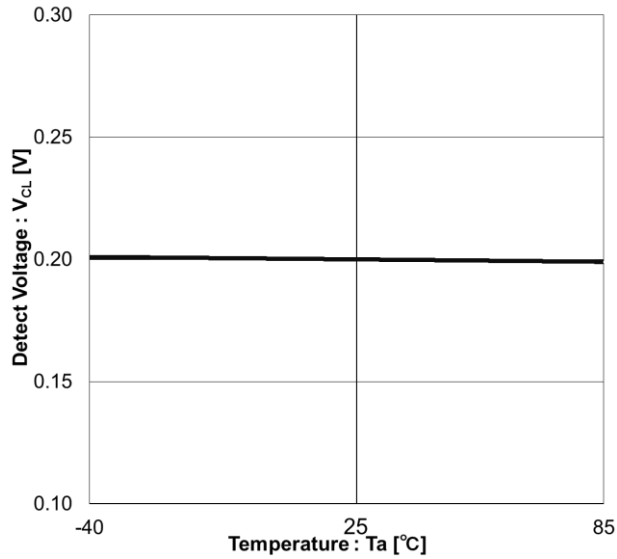

Figure 13. Detect Voltage vs Temperature

Typical Performance Curves (Reference Data) – continued

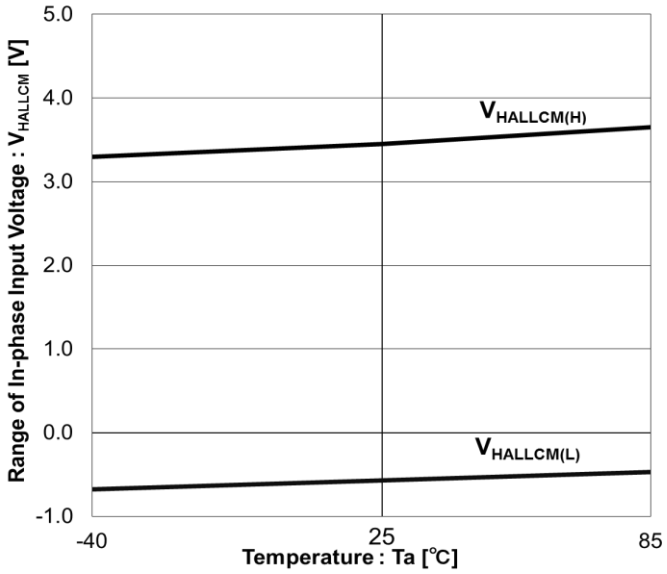

Figure 14. Range of In-phase Input Voltage vs Temperature

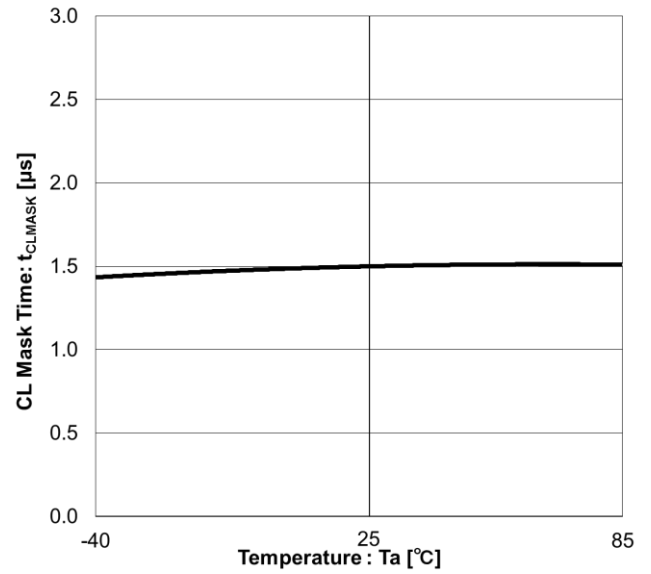

Figure 15. CL Mask Time vs Temperature

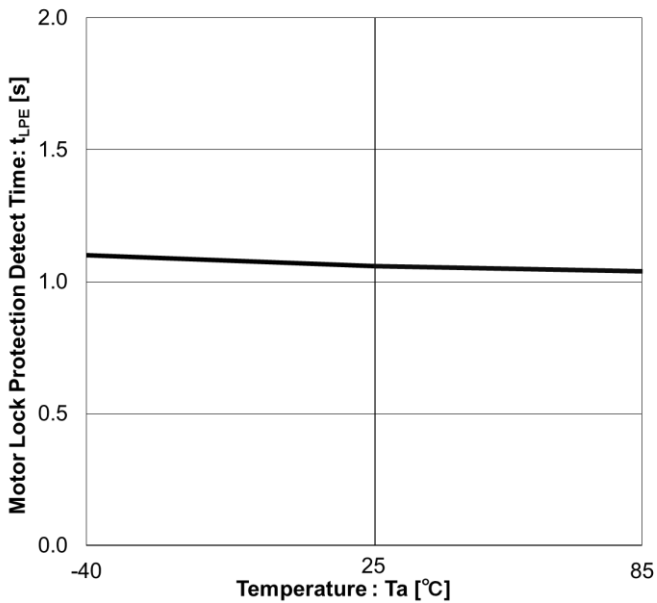
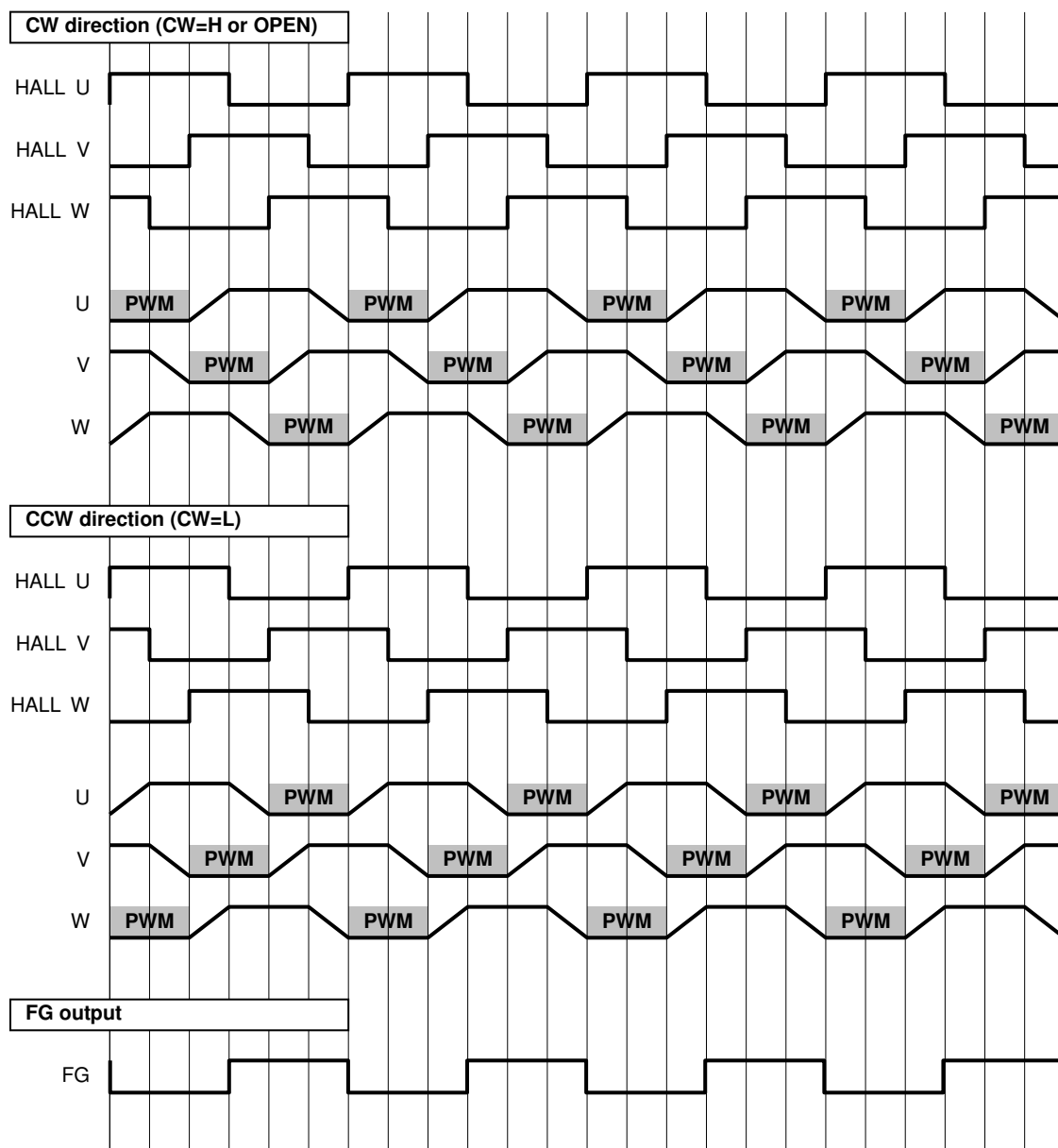
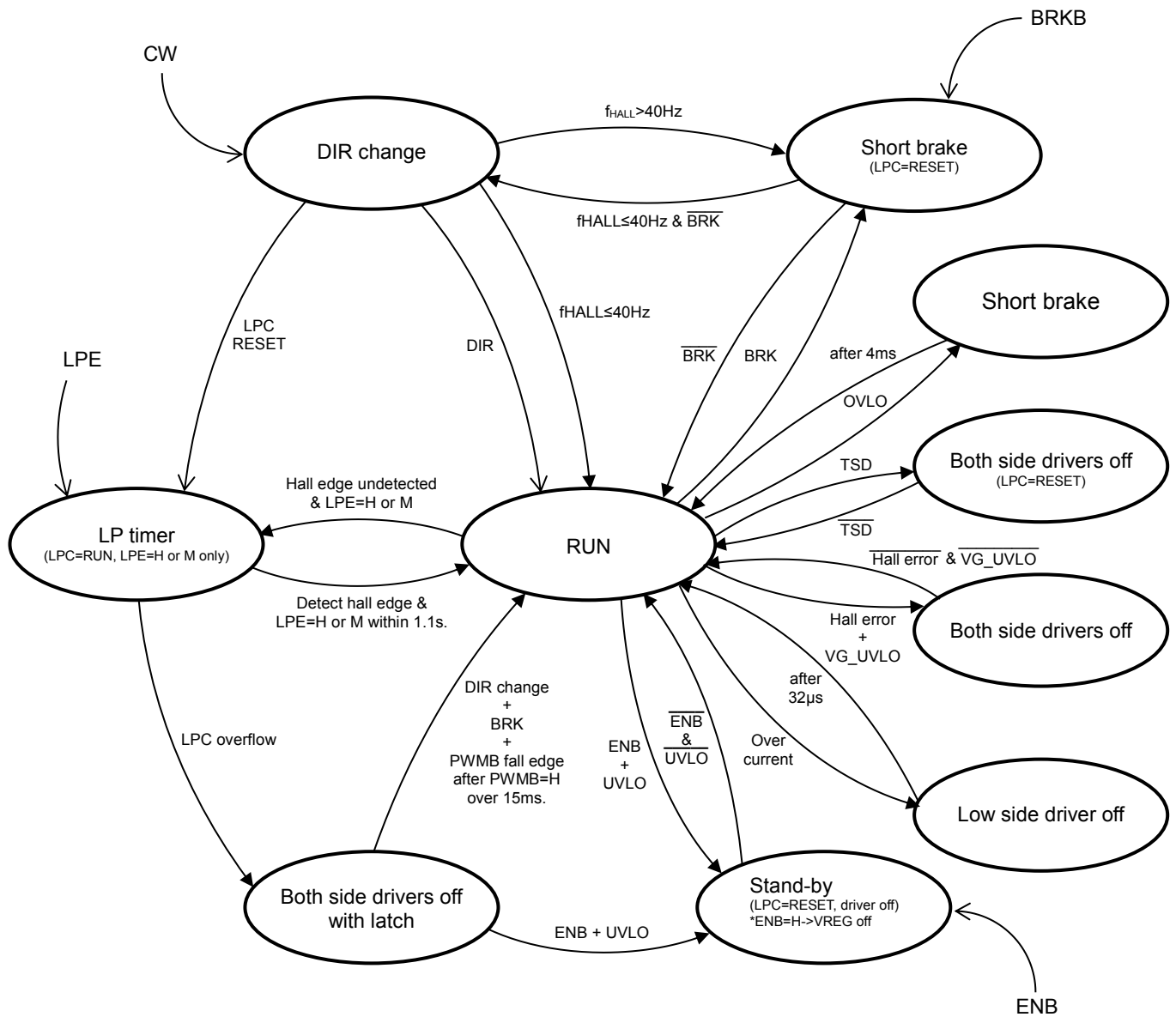

Figure 16. Motor Lock Protection Detect Time vs Temperature

Timing Chart



State Transition Diagram



Legend:

- DIR: motor rotational direction
- LP: motor lock protection
- LPC: internal counter for the motor lock protection (watch-dog timer)
- f_{HALL} : hall signal frequency
- Hall error: HU=HV=HW
- &: logical "AND"
- +: logical "OR"

- State transition
- Command signal

(Note) All values are typical.

I/O Equivalence Circuits

<p>FG</p>		<p>HUP HUN HVP HVN HWP HWN</p>	
<p>PWMB BRKB CW</p>		<p>VREG</p>	
<p>ENB</p>		<p>LPE</p>	
<p>UL VL WL</p>		<p>CP1</p>	
<p>UH VH WH U V W</p>		<p>VG CP2 VCC</p>	
<p>RCL</p>			

Figure 17. I/O Equivalence Circuits

Operational Notes

1. Reverse Connection of Power Supply

Connecting the power supply in reverse polarity can damage the IC. Take precautions against reverse polarity when connecting the power supply, such as mounting an external diode between the power supply and the IC's power supply pins.

2. Power Supply Lines

Design the PCB layout pattern to provide low impedance supply lines. Furthermore, connect a capacitor to ground at all power supply pins. Consider the effect of temperature and aging on the capacitance value when using electrolytic capacitors.

3. Ground Voltage

Ensure that no pins are at a voltage below that of the ground pin at any time, even during transient condition. However, U, V, W and RCL pin may inevitably go below ground due to back EMF or electromotive force. In such cases, the user should make sure that such voltages going below ground will not cause the IC and the system to malfunction by examining carefully all relevant factors and conditions such as motor characteristics, supply voltage, operating frequency and PCB wiring to name a few.

4. Ground Wiring Pattern

When using both small-signal and large-current ground traces, the two ground traces should be routed separately but connected to a single ground at the reference point of the application board to avoid fluctuations in the small-signal ground caused by large currents. Also ensure that the ground traces of external components do not cause variations on the ground voltage. The ground lines must be as short and thick as possible to reduce line impedance.

5. Recommended Operating Conditions

The function and operation of the IC are guaranteed within the range specified by the recommended operating conditions. The characteristic values are guaranteed only under the conditions of each item specified by the electrical characteristics.

6. Inrush Current

When power is first supplied to the IC, it is possible that the internal logic may be unstable and inrush current may flow instantaneously due to the internal powering sequence and delays, especially if the IC has more than one power supply. Therefore, give special consideration to power coupling capacitance, power wiring, width of ground wiring, and routing of connections.

7. Operation Under Strong Electromagnetic Field

Operating the IC in the presence of a strong electromagnetic field may cause the IC to malfunction.

8. Testing on Application Boards

When testing the IC on an application board, connecting a capacitor directly to a low-impedance output pin may subject the IC to stress. Always discharge capacitors completely after each process or step. The IC's power supply should always be turned off completely before connecting or removing it from the test setup during the inspection process. To prevent damage from static discharge, ground the IC during assembly and use similar precautions during transport and storage.

Operational Notes – continued

9. **Inter-pin Short and Mounting Errors**

Ensure that the direction and position are correct when mounting the IC on the PCB. Incorrect mounting may result in damaging the IC. Avoid nearby pins being shorted to each other especially to ground, power supply and output pin. Inter-pin shorts could be due to many reasons such as metal particles, water droplets (in very humid environment) and unintentional solder bridge deposited in between pins during assembly to name a few.

10. **Unused Input Pins**

Input pins of an IC are often connected to the gate of a MOS transistor. The gate has extremely high impedance and extremely low capacitance. If left unconnected, the electric field from the outside can easily charge it. The small charge acquired in this way is enough to produce a significant effect on the conduction through the transistor and cause unexpected operation of the IC. So unless otherwise specified, unused input pins should be connected to the power supply or ground line.

11. **Regarding the Input Pin of the IC**

This monolithic IC contains P+ isolation and P substrate layers between adjacent elements in order to keep them isolated. P-N junctions are formed at the intersection of the P layers with the N layers of other elements, creating a parasitic diode or transistor. For example (refer to figure below):

- When $GND > Pin A$ and $GND > Pin B$, the P-N junction operates as a parasitic diode.
- When $GND > Pin B$, the P-N junction operates as a parasitic transistor.

Parasitic diodes inevitably occur in the structure of the IC. The operation of parasitic diodes can result in mutual interference among circuits, operational faults, or physical damage. Therefore, conditions that cause these diodes to operate, such as applying a voltage lower than the GND voltage to an input pin (and thus to the P substrate) should be avoided.

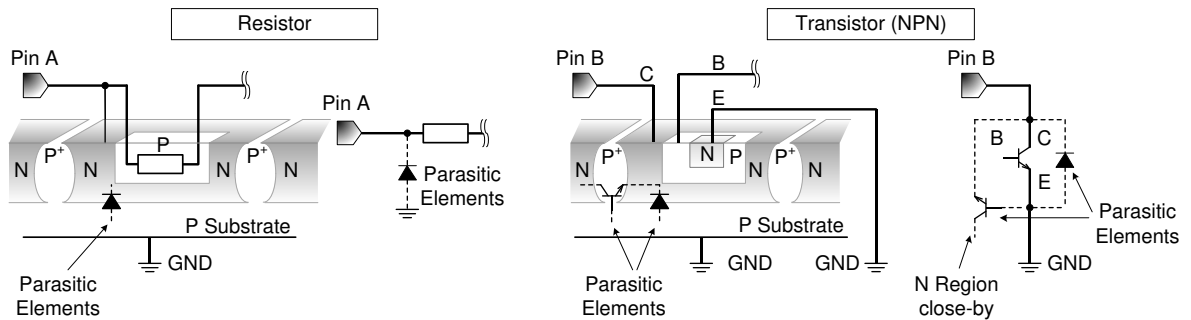

Figure 18. Example of Monolithic IC Structure

12. **Ceramic Capacitor**

When using a ceramic capacitor, determine a capacitance value considering the change of capacitance with temperature and the decrease in nominal capacitance due to DC bias and others.

13. **Thermal Shutdown Circuit (TSD)**

This IC has a built-in thermal shutdown circuit that prevents heat damage to the IC. Normal operation should always be within the IC's maximum junction temperature rating. If however the rating is exceeded for a continued period, the junction temperature (T_j) will rise which will activate the TSD circuit that will turn OFF power output pins. When the T_j falls below the TSD threshold, the circuits are automatically restored to normal operation.

Note that the TSD circuit operates in a situation that exceeds the absolute maximum ratings and therefore, under no circumstances, should the TSD circuit be used in a set design or for any purpose other than protecting the IC from heat damage.

Ordering Information

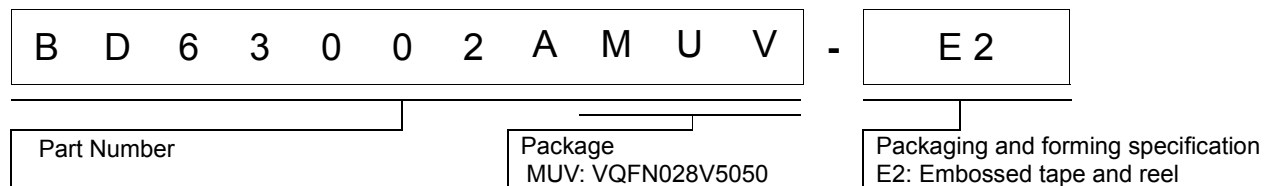

Marking Diagram

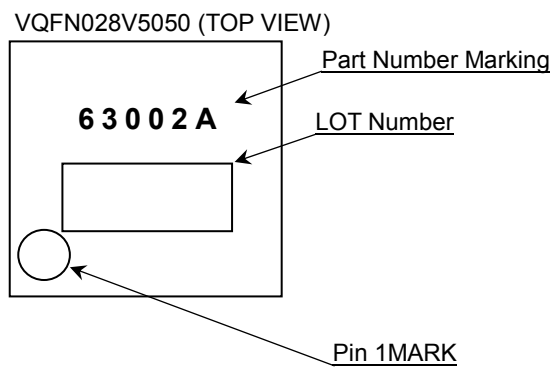

Physical Dimension and Packing Information

Package Name	VQFN028V5050
--------------	--------------

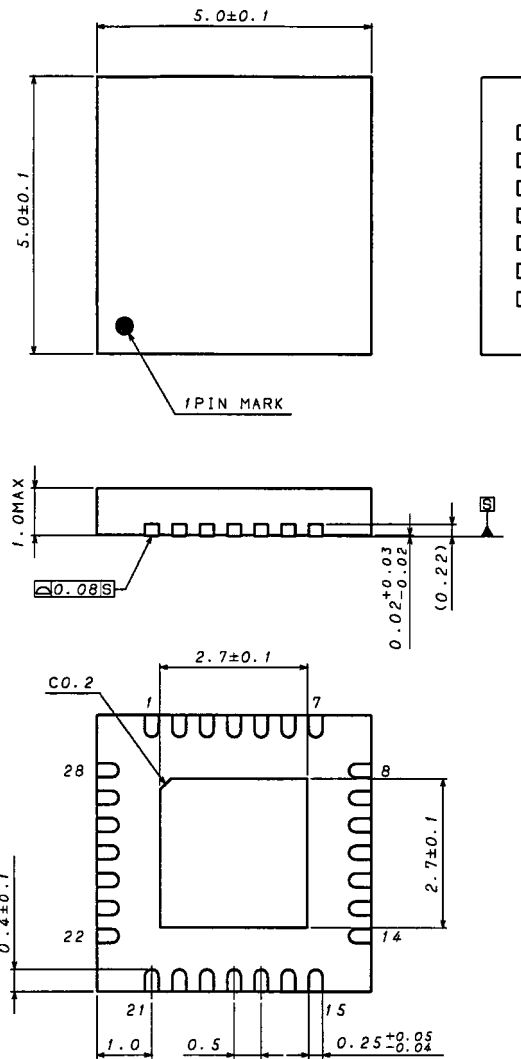

(UNIT: mm)

PKG: VQFN028V5050
Drawing No. EX473-5002-2

<Tape and Reel information>

Tape	Embossed carrier tape
Quantity	2500pcs
Direction of feed	E2 (The direction is the 1pin of product is at the upper left when you hold reel on the left hand and you pull out the tape on the right hand)

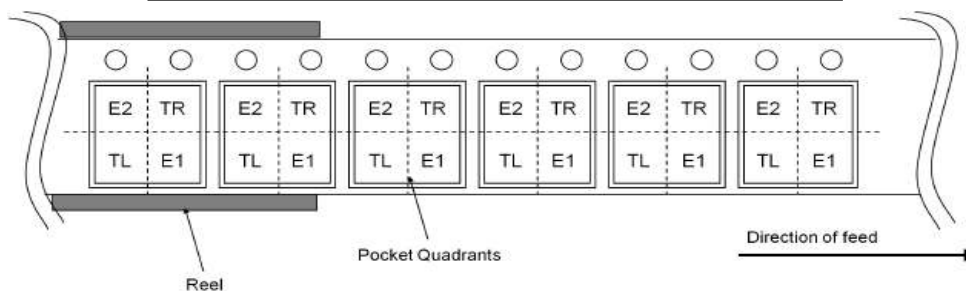

Revision History

Date	Revision	Changes
11.Jun.2018	001	New Release

Notice

Precaution on using ROHM Products

- Our Products are designed and manufactured for application in ordinary electronic equipment (such as AV equipment, OA equipment, telecommunication equipment, home electronic appliances, amusement equipment, etc.). If you intend to use our Products in devices requiring extremely high reliability (such as medical equipment ^(Note 1), transport equipment, traffic equipment, aircraft/spacecraft, nuclear power controllers, fuel controllers, car equipment including car accessories, safety devices, etc.) and whose malfunction or failure may cause loss of human life, bodily injury or serious damage to property ("Specific Applications"), please consult with the ROHM sales representative in advance. Unless otherwise agreed in writing by ROHM in advance, ROHM shall not be in any way responsible or liable for any damages, expenses or losses incurred by you or third parties arising from the use of any ROHM's Products for Specific Applications.

(Note1) Medical Equipment Classification of the Specific Applications

JAPAN	USA	EU	CHINA
CLASS III	CLASS III	CLASS II b	CLASS III
CLASS IV		CLASS III	

- ROHM designs and manufactures its Products subject to strict quality control system. However, semiconductor products can fail or malfunction at a certain rate. Please be sure to implement, at your own responsibilities, adequate safety measures including but not limited to fail-safe design against the physical injury, damage to any property, which a failure or malfunction of our Products may cause. The following are examples of safety measures:
 - Installation of protection circuits or other protective devices to improve system safety
 - Installation of redundant circuits to reduce the impact of single or multiple circuit failure
- Our Products are designed and manufactured for use under standard conditions and not under any special or extraordinary environments or conditions, as exemplified below. Accordingly, ROHM shall not be in any way responsible or liable for any damages, expenses or losses arising from the use of any ROHM's Products under any special or extraordinary environments or conditions. If you intend to use our Products under any special or extraordinary environments or conditions (as exemplified below), your independent verification and confirmation of product performance, reliability, etc. prior to use, must be necessary:
 - Use of our Products in any types of liquid, including water, oils, chemicals, and organic solvents
 - Use of our Products outdoors or in places where the Products are exposed to direct sunlight or dust
 - Use of our Products in places where the Products are exposed to sea wind or corrosive gases, including Cl₂, H₂S, NH₃, SO₂, and NO₂
 - Use of our Products in places where the Products are exposed to static electricity or electromagnetic waves
 - Use of our Products in proximity to heat-producing components, plastic cords, or other flammable items
 - Sealing or coating our Products with resin or other coating materials
 - Use of our Products without cleaning residue of flux (even if you use no-clean type fluxes, cleaning residue of flux is recommended); or Washing our Products by using water or water-soluble cleaning agents for cleaning residue after soldering
 - Use of the Products in places subject to dew condensation
- The Products are not subject to radiation-proof design.
- Please verify and confirm characteristics of the final or mounted products in using the Products.
- In particular, if a transient load (a large amount of load applied in a short period of time, such as pulse. is applied, confirmation of performance characteristics after on-board mounting is strongly recommended. Avoid applying power exceeding normal rated power; exceeding the power rating under steady-state loading condition may negatively affect product performance and reliability.
- De-rate Power Dissipation depending on ambient temperature. When used in sealed area, confirm that it is the use in the range that does not exceed the maximum junction temperature.
- Confirm that operation temperature is within the specified range described in the product specification.
- ROHM shall not be in any way responsible or liable for failure induced under deviant condition from what is defined in this document.

Precaution for Mounting / Circuit board design

- When a highly active halogenous (chlorine, bromine, etc.) flux is used, the residue of flux may negatively affect product performance and reliability.
- In principle, the reflow soldering method must be used on a surface-mount products, the flow soldering method must be used on a through hole mount products. If the flow soldering method is preferred on a surface-mount products, please consult with the ROHM representative in advance.

For details, please refer to ROHM Mounting specification

Precautions Regarding Application Examples and External Circuits

1. If change is made to the constant of an external circuit, please allow a sufficient margin considering variations of the characteristics of the Products and external components, including transient characteristics, as well as static characteristics.
2. You agree that application notes, reference designs, and associated data and information contained in this document are presented only as guidance for Products use. Therefore, in case you use such information, you are solely responsible for it and you must exercise your own independent verification and judgment in the use of such information contained in this document. ROHM shall not be in any way responsible or liable for any damages, expenses or losses incurred by you or third parties arising from the use of such information.

Precaution for Electrostatic

This Product is electrostatic sensitive product, which may be damaged due to electrostatic discharge. Please take proper caution in your manufacturing process and storage so that voltage exceeding the Products maximum rating will not be applied to Products. Please take special care under dry condition (e.g. Grounding of human body / equipment / solder iron, isolation from charged objects, setting of ionizer, friction prevention and temperature / humidity control).

Precaution for Storage / Transportation

1. Product performance and soldered connections may deteriorate if the Products are stored in the places where:
 - [a] the Products are exposed to sea winds or corrosive gases, including Cl₂, H₂S, NH₃, SO₂, and NO₂
 - [b] the temperature or humidity exceeds those recommended by ROHM
 - [c] the Products are exposed to direct sunshine or condensation
 - [d] the Products are exposed to high Electrostatic
2. Even under ROHM recommended storage condition, solderability of products out of recommended storage time period may be degraded. It is strongly recommended to confirm solderability before using Products of which storage time is exceeding the recommended storage time period.
3. Store / transport cartons in the correct direction, which is indicated on a carton with a symbol. Otherwise bent leads may occur due to excessive stress applied when dropping of a carton.
4. Use Products within the specified time after opening a humidity barrier bag. Baking is required before using Products of which storage time is exceeding the recommended storage time period.

Precaution for Product Label

A two-dimensional barcode printed on ROHM Products label is for ROHM's internal use only.

Precaution for Disposition

When disposing Products please dispose them properly using an authorized industry waste company.

Precaution for Foreign Exchange and Foreign Trade act

Since concerned goods might be fallen under listed items of export control prescribed by Foreign exchange and Foreign trade act, please consult with ROHM in case of export.

Precaution Regarding Intellectual Property Rights

1. All information and data including but not limited to application example contained in this document is for reference only. ROHM does not warrant that foregoing information or data will not infringe any intellectual property rights or any other rights of any third party regarding such information or data.
2. ROHM shall not have any obligations where the claims, actions or demands arising from the combination of the Products with other articles such as components, circuits, systems or external equipment (including software).
3. No license, expressly or implied, is granted hereby under any intellectual property rights or other rights of ROHM or any third parties with respect to the Products or the information contained in this document. Provided, however, that ROHM will not assert its intellectual property rights or other rights against you or your customers to the extent necessary to manufacture or sell products containing the Products, subject to the terms and conditions herein.

Other Precaution

1. This document may not be reprinted or reproduced, in whole or in part, without prior written consent of ROHM.
2. The Products may not be disassembled, converted, modified, reproduced or otherwise changed without prior written consent of ROHM.
3. In no event shall you use in any way whatsoever the Products and the related technical information contained in the Products or this document for any military purposes, including but not limited to, the development of mass-destruction weapons.
4. The proper names of companies or products described in this document are trademarks or registered trademarks of ROHM, its affiliated companies or third parties.

General Precaution

1. Before you use our Products, you are requested to carefully read this document and fully understand its contents. ROHM shall not be in any way responsible or liable for failure, malfunction or accident arising from the use of any ROHM's Products against warning, caution or note contained in this document.
2. All information contained in this document is current as of the issuing date and subject to change without any prior notice. Before purchasing or using ROHM's Products, please confirm the latest information with a ROHM sales representative.
3. The information contained in this document is provided on an "as is" basis and ROHM does not warrant that all information contained in this document is accurate and/or error-free. ROHM shall not be in any way responsible or liable for any damages, expenses or losses incurred by you or third parties resulting from inaccuracy or errors of or concerning such information.