

***TPA6010A4***  
***Audio Power Amplifier***  
***Evaluation Module***

*User's Guide*

## **IMPORTANT NOTICE**

Texas Instruments and its subsidiaries (TI) reserve the right to make changes to their products or to discontinue any product or service without notice, and advise customers to obtain the latest version of relevant information to verify, before placing orders, that information being relied on is current and complete. All products are sold subject to the terms and conditions of sale supplied at the time of order acknowledgment, including those pertaining to warranty, patent infringement, and limitation of liability.

TI warrants performance of its semiconductor products to the specifications applicable at the time of sale in accordance with TI's standard warranty. Testing and other quality control techniques are utilized to the extent TI deems necessary to support this warranty. Specific testing of all parameters of each device is not necessarily performed, except those mandated by government requirements.

Customers are responsible for their applications using TI components.

In order to minimize risks associated with the customer's applications, adequate design and operating safeguards must be provided by the customer to minimize inherent or procedural hazards.

TI assumes no liability for applications assistance or customer product design. TI does not warrant or represent that any license, either express or implied, is granted under any patent right, copyright, mask work right, or other intellectual property right of TI covering or relating to any combination, machine, or process in which such semiconductor products or services might be or are used. TI's publication of information regarding any third party's products or services does not constitute TI's approval, warranty or endorsement thereof.

# Preface

---

---

---

---

## ***Related Documentation From Texas Instruments***

- ***TI Plug-N-Play Audio Amplifier Evaluation Platform*** (literature number SLOU011) provides detailed information on the evaluation platform and its use with TI audio evaluation modules.
- ***TPA6010A4 STEREO 2-W AUDIO POWER AMPLIFIER WITH BASS BOOST AND DC VOLUME CONTROL*** (literature number SLOS268) This is the data sheet for the TPA6010A4 audio amplifier integrated circuit.
- ***TLV2450, TLV2451, TLV2452, TLV2453, TLV2454, TLV2455, TLV245xA FAMILY OF 23-MA 220kHz RAIL-TO-RAIL INPUT/OUTPUT OPERATIONAL AMPLIFIERS WITH SHUTDOWN*** (literature number SLOS218) This is the data sheet for the TLV2450 op amp integrated circuit used on the EVM.

## ***FCC Warning***

This equipment is intended for use in a laboratory test environment only. It generates, uses, and can radiate radio frequency energy and has not been tested for compliance with the limits of computing devices pursuant to subpart J of part 15 of FCC rules, which are designed to provide reasonable protection against radio frequency interference. Operation of this equipment in other environments may cause interference with radio communications, in which case the user at his own expense will be required to take whatever measures may be required to correct this interference.



# Contents

---

---

---

<b>1</b>	<b>Introduction</b>	<b>1-1</b>
1.1	Feature Highlights	1-2
1.2	Description	1-3
1.3	TPA6010A4 EVM Specifications	1-3
<b>2</b>	<b>Operation</b>	<b>2-1</b>
2.1	Precautions	2-2
2.2	Quick Start List for Platform	2-3
2.3	Quick Start List for Stand-Alone	2-6
2.4	Stand-Alone Connection Diagrams	2-8
2.4.1	TPA6010A4 EVM Connected for Stereo BTL Output	2-8
2.4.2	TPA6010A4 EVM Connected for Stereo Single-Ended Output	2-9
2.5	Reference	2-10
2.5.1	EVM Schematic	2-10
2.5.2	EVM Parts List	2-11
2.5.3	Module PCB Layers	2-12

# Figures

---

---

---

1-1	The TI TPA6010A4 Audio Amplifier Evaluation Module	1-3
2-1	Quick Start Platform Map	2-2
2-2	Module Preparation	2-4
2-3	Quick Start Module Map	2-6
2-4	TPA6010A4 EVM Connected for Stereo BTL Output	2-8
2-5	TPA6010A4 EVM Connected for Stereo Single-Ended Output	2-9
2-6	TPA6010A4 EVM Schematic Diagram	2-10
2-7	TPA6010A4 EVM PCB	2-12
2-8	TPA6010A4 EVM Layer 2 — Power	2-12
2-9	TPA6010A4 EVM Layer 3 — Ground	2-13
2-10	TPA6010A4 EVM Bottom Layer	2-13

# Tables

---

---

---

2-1	Typical TI Plug-N-Play Platform Jumper and Switch Settings for the TPA6010A4	2-1
2-2	Typical TPA6010A4 EVM Jumper Settings	2-1
2-3	Platform Jumper and Switch Settings for the TPA6010A4	2-3
2-4	Typical TPA6010A4 EVM Jumper Settings	2-4
2-5	Typical TPA6010A4 EVM Jumper Settings for Stereo BTL Stand-Alone	2-8
2-6	Typical TPA6010A4 EVM Jumper Settings for Stereo Single-Ended Stand-Alone	2-9
2-7	TPA6010A4 EVM Parts List	2-11



# Introduction

---

---

---

---

This chapter provides an overview of the Texas Instruments TPA6010A4 audio amplifier evaluation module (SLOP334). It includes a list of EVM features, a brief description of the module illustrated with a pictorial diagram, and a list of EVM specifications.

<b>Topic</b>	<b>Page</b>
<b>1.1 Feature Highlights</b> .....	<b>1-2</b>
<b>1.2 Description</b> .....	<b>1-3</b>
<b>1.3 TPA6010A4 EVM Specifications</b> .....	<b>1-3</b>

## 1.1 Feature Highlights

The TI TPA6010A4 audio amplifier evaluation module and the TI plug-n-play audio amplifier evaluation platform include the following features:

- ❑ TPA6010A4 audio power amplifier evaluation module
  - Bass boost (with tunable active and passive filters)
  - Compatible with PC99 desktop line-out into 10-k $\Omega$  load
  - Compatible with PC99 portable into 8- $\Omega$  load
  - Internal depop circuitry to minimize transients in outputs
  - Dual channel, bridge-tied load (BTL) or single-ended operation
  - 2 W per channel output power into 3  $\Omega$  at 5 V, BTL
  - Line outs (LDOCK out, RDOCK out)
  - Low current consumption in shutdown mode (60  $\mu$ A)
  - Internal input MUX selects among two sets of stereo inputs
  - DC voltage volume control from +20 dB to –40 dB
  - Differential stereo inputs
  - PC Beep input (must be dc-blocked)
  
- ❑ Quick and easy configuration with the TI plug-n-play audio amplifier evaluation platform
  - Evaluation module is designed to simply plug into the platform, automatically making all signal, control, and power connections
  - Platform provides flexible power options
  - Jumpers on the platform select power and module control options
  - Switches on the platform route signals
  - Platform provides quick and easy audio input and output connections
  
- ❑ Platform power options
  - External 5-V – 15-V DC  $V_{CC}$  supply inputs
  - External regulated  $V_{DD}$  supply input
  - Socket for onboard 5 V/3.3 V  $V_{DD}$  voltage regulator EVM
  - Onboard overvoltage and reverse polarity power protection
  
- ❑ Platform audio input and output connections
  - Left and right RCA phono jack inputs
  - Miniature stereo phone jack input
  - Left and right RCA phono jack outputs
  - Left and right compression speaker terminal outputs
  - Miniature stereo headphone jack output



## 1.2 Description

The TPA6010A4 audio power amplifier evaluation module is a complete, 2-watt per channel stereo audio power amplifier with bass boost and dc volume control. It consists of the TI TPA6010A4 stereo 2-W audio power amplifier IC along with a small number of other parts mounted on a circuit board that measures approximately 2 1/4 inches by 1 1/2 inches (Figure 1–1).

Figure 1–1. The TI TPA6010A4 Audio Amplifier Evaluation Module

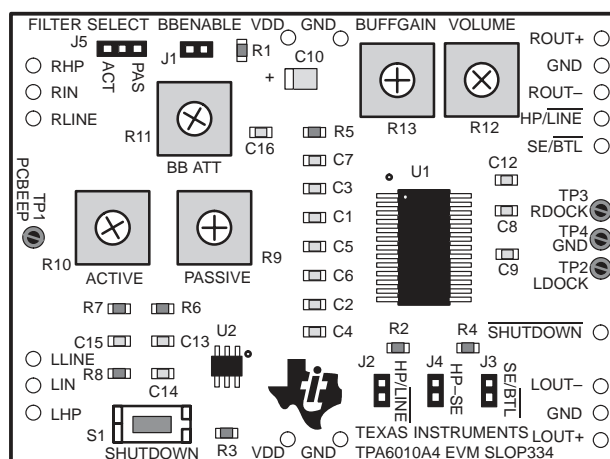

Single in-line header pins extend from the underside of the module circuit board to allow the EVM to be plugged into the TI plug-n-play audio amplifier evaluation platform, or to be wired directly into existing circuits and equipment when used stand-alone.

The platform has room for a single TPA6010A4 evaluation module and is a convenient vehicle for demonstrating TI's audio power amplifier and related evaluation modules. The EVMs simply plug into the platform, which automatically provides power to the modules, interconnects them correctly, and connects them to a versatile array of standard audio input and output jacks and connectors. Easy-to-use configuration controls allow the platform and EVMs to quickly model many possible end-equipment configurations.

There is nothing to build, nothing to solder, and nothing but the speakers included with the platform to *hook up*.

## 1.3 TPA6010A4 EVM Specifications

Supply voltage range, $V_{DD}$ .....	4.5 V to 5.5 V
Supply current, $I_{DD}$ .....	2 A max
Continuous output power per channel, $P_O$ : 3- $\Omega$ BTL, $V_{DD}=5$ V .....	2 W
Audio input voltage, $V_I$ :	
HP input .....	5 Vpp max
Line input .....	5 Vpp max
PC BEEP input .....	5 Vpp max
Minimum load impedance, $R_L$ .....	3 $\Omega$
Minimum line out load impedance .....	1 k $\Omega$



## Operation

The quick start lists in this chapter contain steps that can be followed to quickly prepare the TPA6010A4 audio amplifier EVM for use either with the TI plug-n-play audio amplifier evaluation platform or for stand-alone operation. Using the EVM with the TI evaluation platform is a quick and easy way to connect power, signal and control inputs, and signal outputs to the EVM.

The platform switch and jumper settings shown in Table 2–1 are typical for the TPA6010A4 EVM and will cause the TPA6010A4 to switch to single-ended output mode when a plug is inserted into platform headphone jack J10.

*Table 2–1. Typical TI Plug-N-Play Platform Jumper and Switch Settings for the TPA6010A4*

EVM	JP6	JP7	JP8	S2	S3
P-N-P Platform	Mode	X	Hi	Note 2	U2–U4

**Notes:** 1) X = Don't care  
 2) Set S2 to ON when signal conditioning board is installed in U1; set S2 to OFF when no signal conditioning board is installed.

*Table 2–2. Typical TPA6010A4 EVM Jumper Settings*

EVM	BBENABLE	HP/LINE	HP-SE	SE/BTL	FILTER SELECT
TPA6010A4	ON	OFF	ON	OFF	ACT

**Note:** ON = Shunt installed, OFF = Open

Topic	Page
2.1 Precautions .....	2–2
2.2 Quick Start List for Platform .....	2–3
2.3 Quick Start List for Stand-Alone .....	2–6
2.4 Stand-Alone Connection Diagrams .....	2–8
2.5 Reference .....	2–10

## 2.1 Precautions

**Power Supply Input Polarity and Maximum Voltage**  
 Always ensure that the polarity and voltage of the external power connected to V<sub>CC</sub> power input connector J1, J2, and/or V<sub>DD</sub> power input connector J6 are correct. Overvoltage or reverse-polarity power applied to these terminals can open onboard soldered-in fuses and cause other damage to the platform, installed evaluation modules, and/or the power source.

**Inserting or Removing EVM Boards**  
 Do not insert or remove EVM boards with power applied — to the EVM board, the platform, or both may result.

Figure 2–1. Quick Start Platform Map

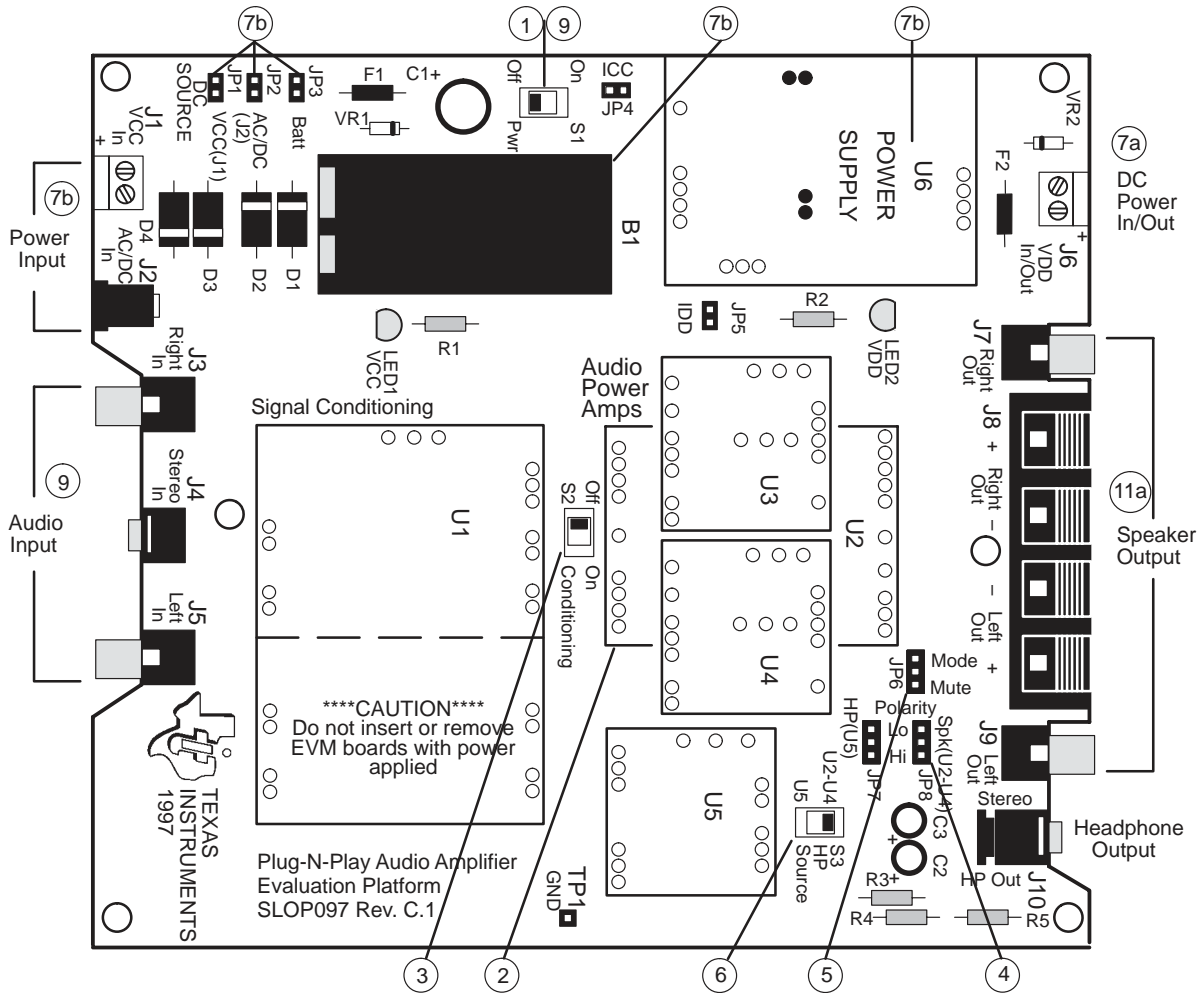

## 2.2 Quick Start List for Platform

Follow these steps when using the TPA6010A4 EVM with the TI plug-n-play audio amplifier evaluation platform (see the platform user's guide, SLOU011, for additional details). Numbered callouts for selected steps are shown in Figure 2–1 and Figure 2–2.

### □ Platform preparations

- 1) Ensure that all external power sources are set to **OFF** and that the platform power switch **S1** is set to **OFF**.
- 2) Install a TPA6010A4 module in platform socket **U2**, taking care to align the module pins correctly.
- 3) Use switch **S2** to select or bypass the signal conditioning EVM (**U1**).
- 4) Set control signal **Polarity** jumper **JP8** to **Hi**.
- 5) Set jumper **JP6** to select the **Mode** control input (causes the TPA6010A4 to switch to the single-ended output mode if a plug is inserted into platform headphone jack **J10**).
- 6) If the headphone jack (**J10**) output will be used, set headphone source switch **S3** to **U2–U4**.

Table 2–3. Platform Jumper and Switch Settings for the TPA6010A4

EVM	JP6	JP7	JP8	S2	S3
P-N-P Platform	Mode	X	Hi	Note 2	U2–U4

**Notes:** 1) X = Don't care  
 2) Set **S2** to **ON** when signal conditioning board is installed in **U1**; set **S2** to **OFF** when no signal conditioning board is installed.

### □ Power supply

- 7) Select and connect the power supply (ensure power supply is set to **OFF**):
  - a) Connect an external regulated power supply set to 5 V to platform  $V_{DD}$  power input connector **J6** taking care to observe marked polarity, or
  - b) Install a voltage regulator EVM (SLVP097 or equiv.) in platform socket **U6**. Connect a 7 V – 12 V power source to a platform  $V_{CC}$  power input **J1** or **J2** and jumper the appropriate power input (see platform user's guide).

### □ Inputs and outputs

- 8) Ensure that the audio signal source level is set to minimum.
- 9) Connect the audio source to left and right RCA phono jacks **J3** and **J5** or stereo miniature phone jack **J4**.
- 10) If PCBEEP is to be used, a dc-blocked 1-V p–p 1-kHz square wave may be applied to the EVM **PCBEEP** test point (**TP1**). (See the TPA6010A4 audio amplifier data sheet (TI lit number SLOS268) for more information.)
- 11) Connect the outputs:
  - a) Connect speakers to left and right RCA jacks **J7** and **J9** or to stripped wire speaker connectors **J8**, and/or
  - b) Connect a line-level load to the EVM **LDOCK** and **RDOCK** terminals that is **no less than 1-k $\Omega$  and is dc-blocked**.

□ Evaluation module preparations

Figure 2–2. Module Preparation

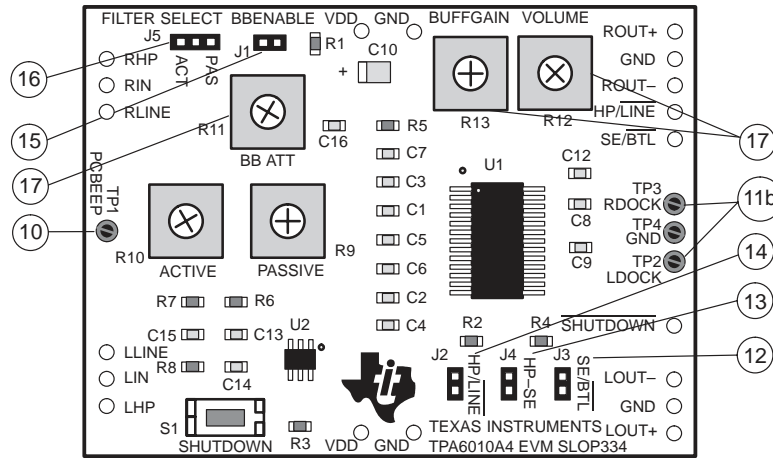

Table 2–4. Typical TPA6010A4 EVM Jumper Settings

EVM	BBENABLE	HP/LINE	HP-SE	SE/BTL	FILTER SELECT
TPA6010A4	ON	OFF	ON	OFF	ACT

Note: ON = Shunt installed, OFF = Open

- 12) To allow the module SE/BTL control input to switch the amplifier IC between single ended (SE) and bridge-tied load (BTL) output modes, set output mode jumper **SE/BTL** to **OFF**. To keep the module amplifier IC in the single-ended output mode regardless of the control input state, set jumper **SE/BTL** to **ON**.
- 13) To allow the module HP/LINE control input to switch the amplifier IC between the HP pins and the LINE pins as the signal inputs, set the input mode jumper **HP/LINE** to **OFF**. To keep the amplifier IC in the HP input mode regardless of the control input state, set jumper **HP/LINE** to **ON**.
- 14) To allow the amplifier IC to switch from the LINE inputs to the HP inputs when the output switches from BTL output mode to SE output mode and vice versa, set jumper **HP-SE** to **ON**. To allow the inputs and output modes to switch independently, set jumper **HP-SE** to **OFF**.
- 15) To enable bass boost, set **BBENABLE** to **ON**. To disable bass boost, set **BBENABLE** to **OFF**.
- 16) To select the onboard active or passive filter, set the **FILTER SELECT** jumper to **ACT** for the active filter or to **PAS** for the passive filter.

**Power Up**

- 17) Ensure that EVM potentiometers **VOLUME**, **BUFFGAIN**, and **BB ATT** are set to their approximate mid points.
- 18) Verify correct voltage and input polarity and set the external power supply to **ON**. If  $V_{CC}$  and an onboard regulator EVM are used to provide  $V_{DD}$ , set platform power switch **S1** to **ON**.

Platform LED2 should light indicating the presence of  $V_{DD}$ , and the evaluation modules installed on the platform should begin operation.

- 19) Adjust the signal source level as needed.

 **Evaluation module controls**

- 20) The EVM **VOLUME** potentiometer controls the volume of the **platform OUT+/-** outputs. Turn this control clockwise to increase the volume.
- 21) The EVM **BUFFGAIN** potentiometer controls the volume to both the **platform OUT+/-** outputs and the **EVM LDOCK/RDOCK** output terminals. Turn this control clockwise to increase the volume.
- 22) The EVM **BB ATT** potentiometer controls the attenuation of the bass boost. Turn this control clockwise to **decrease** the bass boost attenuation.
- 23) The EVM **ACTIVE** and **PASSIVE** potentiometers control the cutoff frequency for their respective filters. Turn these controls clockwise to **increase** the filter cutoff frequency.

## 2.3 Quick Start List for Stand-Alone

Follow these steps to use the TPA6010A4 EVM stand-alone or when connecting it into existing circuits or equipment. Connections to the TPA6010A4 module header pins can be made via individual sockets, wire-wrapping, or soldering to the pins, either on the top or the bottom of the module. Numbered callouts for selected steps are shown in Figure 2–3.

Figure 2–3. Quick Start Module Map

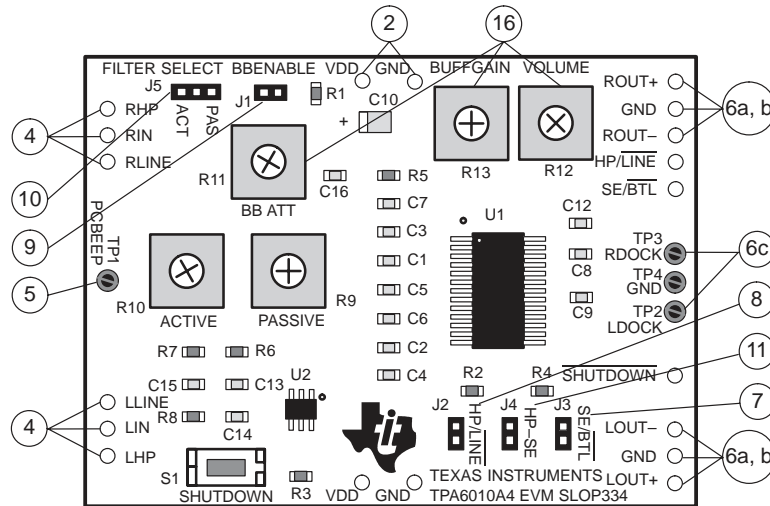

### ❑ Power supply

- 1) Ensure that all external power sources are set to **OFF**.
- 2) Connect an external regulated power supply set to 5 V to the module **VDD** and **GND** pins taking care to observe marked polarity.

### ❑ Inputs and outputs

- 3) Ensure that audio signal source level adjustments are set to minimum.
- 4) Connect the right (left) positive lead of the audio source to the module **RLINE** (**LLINE**) pins and the negative lead to the **RIN** (**LIN**) pins. If using the headphone inputs, connect the positive audio source to the module **RHP** (**LHP**) and the negative lead to **RIN** (**LIN**). The inputs can be used with a differential or single-ended audio source, but the headphone and line have common positive inputs.
- 5) If **PCBEEP** is to be used, a dc-blocked 1-V p-p 1-kHz square wave may be applied to the EVM **PCBEEP** test point (**TP1**). (See the TPA6010A4 audio amplifier data sheet (TI lit number SLOS268) for more information.)
- 6) Select output mode:
  - a) For BTL output, connect a speaker to the module **OUT+** and **OUT-** pins of each channel, (Figure 2–4)  
or
  - b) For single-ended output, connect a headphone or a speaker to the module **OUT+** and **GND** pins of each channel through a 33  $\mu$ F to 1000  $\mu$ F output-coupling capacitor (Figure 2–5).  
or
  - c) Connect a line-level load to the EVM **LDOCK** and **RDOCK** terminals that is **no less than 1-k $\Omega$  and is dc-blocked**.



### □ Evaluation module preparations

- 7) To allow the module  $\overline{\text{SE/BTL}}$  control input to switch the amplifier IC between single ended (SE) and bridge-tied load (BTL) output modes, set output mode jumper **SE/BTL** to **OFF**. To keep the module amplifier IC in the single-ended output mode regardless of the control input state, set jumper **SE/BTL** to **ON**.
- 8) To allow the module  $\overline{\text{HP/LINE}}$  control input to switch the amplifier IC between the HP pins and the  $\overline{\text{LINE}}$  pins as the signal inputs, set the input mode jumper **HP/LINE** to **OFF**. To keep the amplifier IC in the HP input mode regardless of the control input state, set jumper **HP/LINE** to **ON**.
- 9) To enable bass boost, set **BBENABLE** to **ON**. To disable bass boost, set **BBENABLE** to **OFF**.
- 10) To select the onboard active or passive filter, set the **FILTER SELECT** jumper to **ACT** for the active filter or to **PAS** for the passive filter.
- 11) To allow the amplifier IC to switch from the  $\overline{\text{LINE}}$  inputs to the HP inputs when the output switches from BTL output mode to SE output mode and vice versa, set jumper **HP-SE** to **ON**. To allow the inputs and output modes to switch independently, set jumper **HP-SE** to **OFF**. Connect control lines to the various module control input pins as needed:
  - a) **SE/BTL**: A high selects the single-ended (SE) output mode; a low or float selects the bridge-tied load (BTL) output mode.
  - b) **HP/LINE**: A high selects the LHP and RHP inputs; a low or float selects the LLINE and RLINE inputs.
  - c) **SHUTDOWN**: A low shuts down the amplifier IC on the module; a high or float allows normal operation.

### □ EVM module controls

- 12) The EVM **VOLUME** potentiometer controls the volume of the **platform OUT+/-** outputs. Turn this control clockwise to increase the volume.
- 13) The EVM **BUFGAIN** potentiometer controls the volume to both the **platform OUT+/-** outputs and the **EVM LDOCK/RDOCK** output terminals. Turn this control clockwise to increase the volume.
- 14) The EVM **BB ATT** potentiometer controls the attenuation of the bass boost. Turn this control clockwise to **decrease** the bass boost attenuation.
- 15) The EVM **ACTIVE** and **PASSIVE** potentiometers control the cutoff frequency for their respective filters. Turn these controls clockwise to **increase** the filter cutoff frequency.

### □ Power-up

- 16) Ensure that EVM potentiometers **VOLUME**, **BUFGAIN**, and **BB ATT** are set to their approximate mid points.
- 17) Verify correct voltage and input polarity and set the external power supply to **ON**.
- 18) Adjust the signal source level as needed.

## 2.4 Stand-Alone Connection Diagrams

The power supply range is 4.5 V to 5.5 V and isolated OUT+ and OUT– lines for BTL operation are required.

Note that the shutdown signal applied to the EVM  $\overline{\text{SHUTDOWN}}$  pin must be able to supply enough current to overcome the pullup resistor on the module (100 k $\Omega$ ).

### 2.4.1 TPA6010A4 EVM Connected for Stereo BTL Output

Figure 2–4 shows the TPA6010A4 EVM connected for stereo BTL operation.

Figure 2–4. TPA6010A4 EVM Connected for Stereo BTL Output

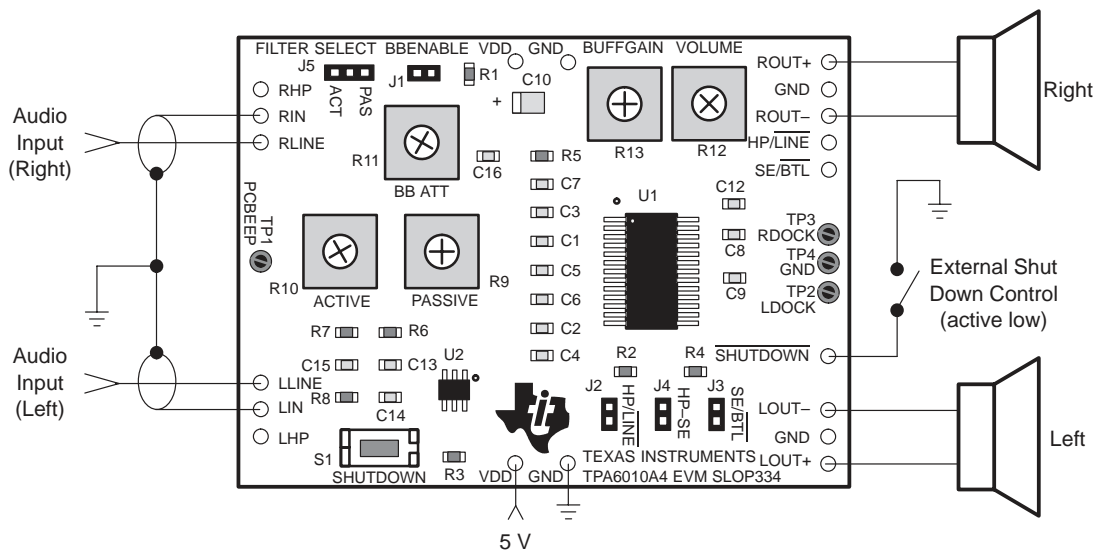

Table 2–5. Typical TPA6010A4 EVM Jumper Settings for Stereo BTL Stand-Alone

EVM	BBENABLE	HP/ $\overline{\text{LINE}}$	HP-SE	SE/ $\overline{\text{BTL}}$	FILTER SELECT
TPA6010A4	ON	OFF	ON	OFF	ACT

**Note:** ON = Shunt installed, OFF = Open

### 2.4.2 TPA6010A4 EVM Connected for Stereo Single-Ended Output

Figure 2–5. TPA6010A4 EVM Connected for Stereo Single-Ended Output

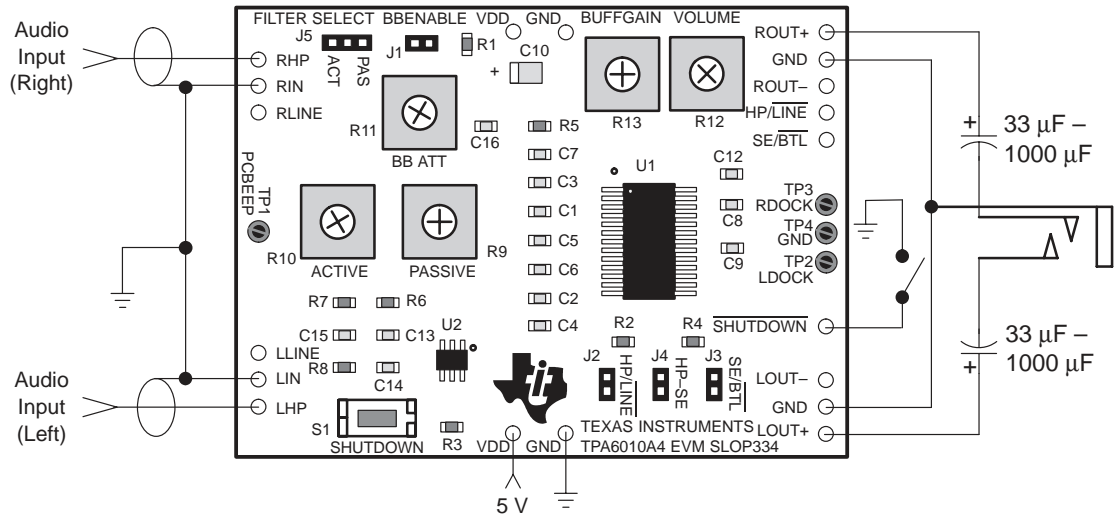

Table 2–6. Typical TPA6010A4 EVM Jumper Settings for Stereo Single-Ended Stand-Alone

EVM	BBENABLE	HP/ $\overline{\text{LINE}}$	HP-SE	SE/ $\overline{\text{BTL}}$	FILTER SELECT
TPA6010A4	ON	OFF	ON	ON	ACT

**Note:** ON = Shunt installed, OFF = Open

## 2.5 Reference

This section includes the TPA6010A4 EVM schematic, the EVM parts list, and the module PCB layers.

### 2.5.1 EVM Schematic

Figure 2–6 shows the TPA6010A4 EVM schematic.

Figure 2–6. TPA6010A4 EVM Schematic Diagram

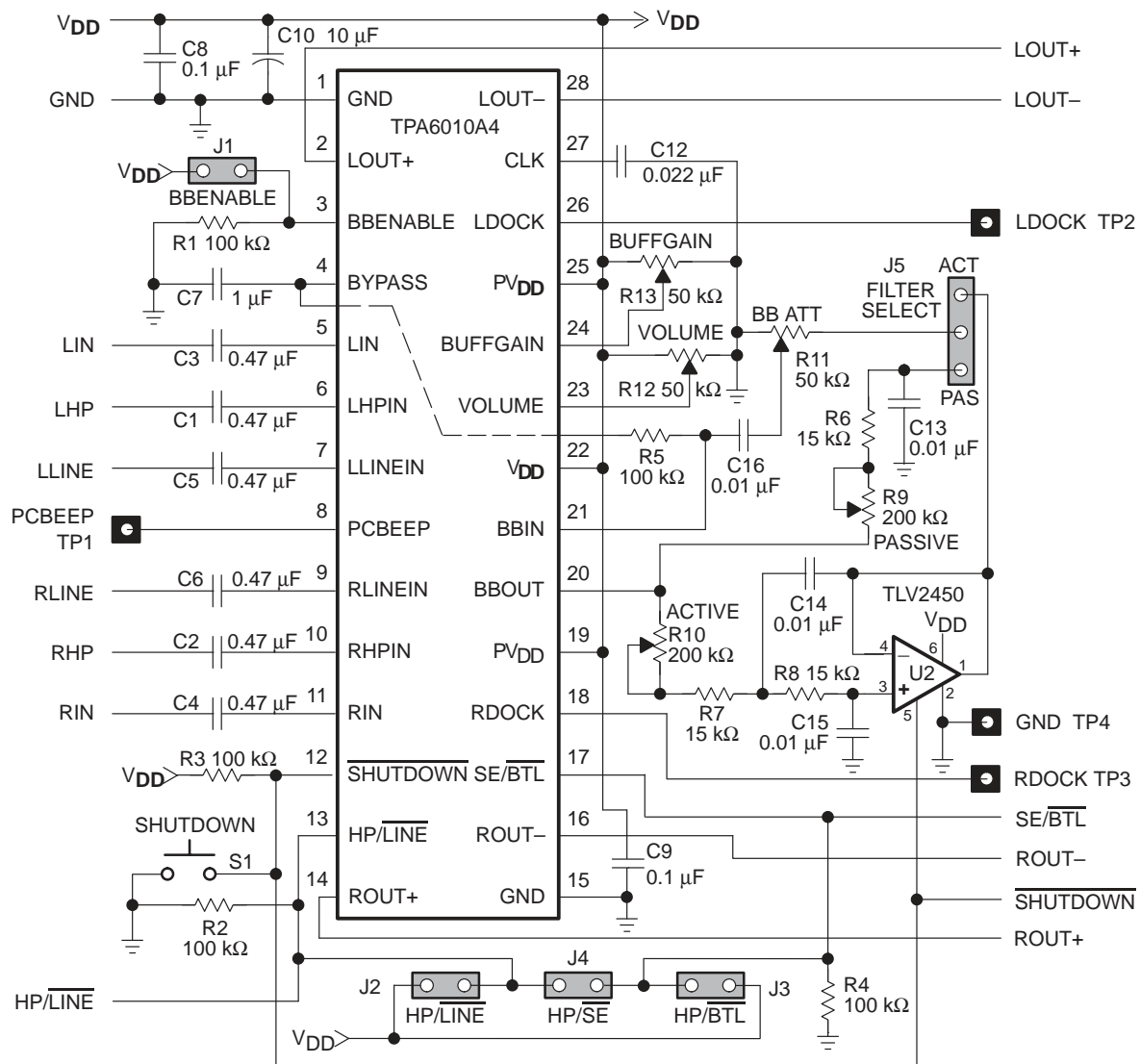

## 2.5.2 EVM Parts List

Table 2–9 is the TPA6010A4 EVM parts list.

Table 2–7. TPA6010A4 EVM Parts List

Ref.	Description	Size	EVM Qty.	Manufacturer/ Part Number	Vendor Number
C8, C9	Capacitor, ceramic chip, 0.1 $\mu$ F @ 16 V, +10%, X7R	0603	2	Murata GRM39X7R104K16	
C1 – C6	Capacitor, 0.47 $\mu$ F @ 16 V +80%/–20%, nonpolarized	0603	6	Panasonic ECJ–1VF1C474Z	
C12	Capacitor, 22 nF @ 16 V +80%/–20%, nonpolarized	0603	1	Panasonic ECJ–1VB1C223K	
C13 – C16	Capacitor, 0.01 $\mu$ F @ 16 V +10%, nonpolarized	0603	4	Panasonic ECJ–1VB1C103K	
C7	Capacitor, 1.0 $\mu$ F @ 16 V +80%/–20%, Y5V		1	Murata GRM40Y5V105Z16	
C10	Capacitor, 10 $\mu$ F @ 6.3 V, SMD	A	2	Panasonic CS–TOJY106R	
R1 – R5	Resistor, 100 k $\Omega$ , 1/16 W, 10%	0603	5	Panasonic ERJ–3GSYJ104V	
R6 – R8	Resistor, 15 k $\Omega$ , 1/16 W, 10%	0603	3	Panasonic ERJ–3GSYJ153V	
R11 – R13	Potentiometer, 50 k $\Omega$ , Cermet ST SL, through-hole		3	Bourns 3362P–503	
R9, R10	Potentiometer, 200 k $\Omega$ , Cermet ST SL, through-hole		3	Bourns 3362P–204	
S1	Switch, momentary	SMD	1	Panasonic 8050SCT–ND	
TP1 – TP4	Test point, red		4	Farnell 240–345	
J1 – J4	Header, 2 position	2 mm	4	Norcomp	
J5	Header, 3 position	2 mm	1	Norcomp	
P1 – P5	Shunts	2 mm	5	2JM–G	
U1	IC, TPA6010A4 2-W stereo audio amplifier	TSSOP–28	1	TI TPA6010A4PWP	
U2	IC, TPV2450 single-supply op amp, 6-pin	SOT–23	1	TI TPV2450DBV	

**Note:** C11 is not used.

### 2.5.3 Module PCB Layers

The following illustrations depict the TPA6010A4 EVM PCB layers and silkscreen. These drawings are not to scale. Gerber plots can be obtained from any TI Sales Office.

Figure 2–7. TPA6010A4 EVM PCB

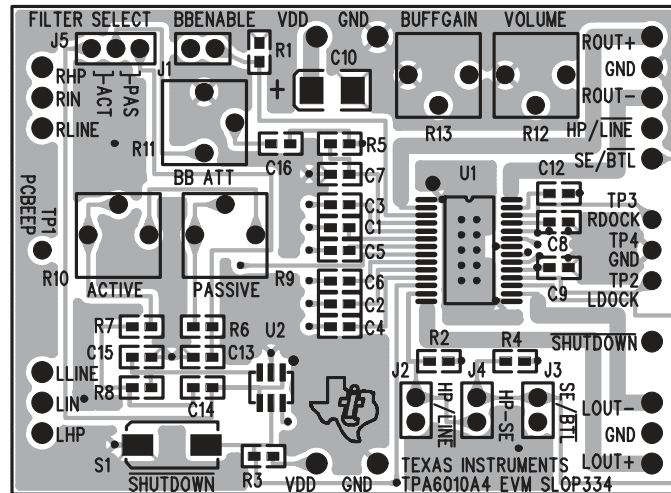
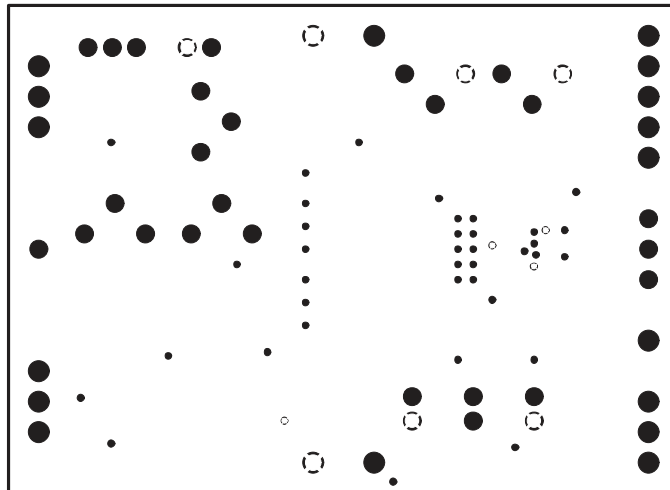
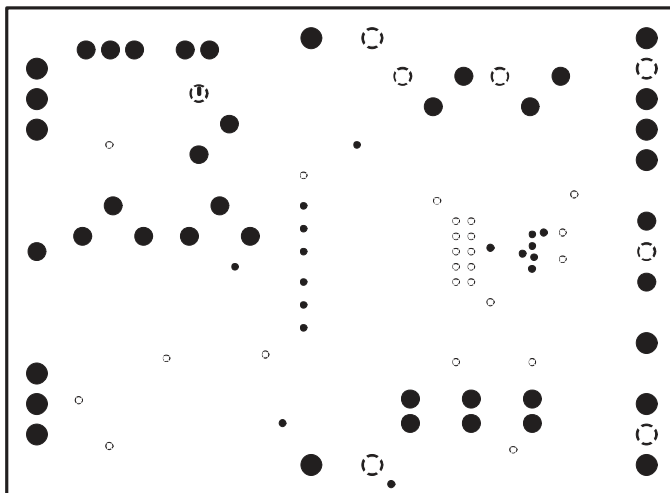

Figure 2–8. TPA6010A4 EVM Layer 2 — Power



**Note:** All open areas are solid copper planes.

Figure 2–9. TPA6010A4 EVM Layer 3 — Ground



**Note:** All open areas are solid copper planes.

Figure 2–10. TPA6010A4 EVM Bottom Layer

