

# 2x2 4G/LTE Screw Mount MIMO Antenna



AEACBK081014-M698



Ø81.6 x 14.5 mm  
RoHS/RoHS II Compliant  
MSL - 1

## FEATURES

- 2 X MIMO antenna
- 4G/LTE operates in 698-2700 MHz
- IP67 rated
- Linear polarization
- Screw mounting

## APPLICATIONS

- 4G/LTE
- Telematics
- Fleet monitoring
- IoT
- Video, Surveillance
- Femtocells
- M2M

## Electrical Specifications

Parameters	Min.	Typ.	Max.	Units	Note
Frequency Range		698~960/1710~2690		MHz	
VSWR			3.5		
Polarization Model		Linear			
Impedance		50		Ω	
Gain (Main & Aux)		2.5		dBi	Zenith

## Mechanical Characteristics

Parameters	Description
Connector	2xSMA Male
Cable Type	2xRG174
Cable Length	3M
Material	ABS
Mount way	Screw
Dimensions	Φ81.3 x 14.6 mm

## Environmental Characteristics

Parameters	Description
Waterproof	IP67
Operating Temperature	-40° to +85°C
Relative Humidity	Up to 95%
MSL Level	1
ROHS Complaint	Yes
Vibration	10 to 55Hz with 1.5mm amplitude 2hours



5101 Hidden Creek Ln Spicewood TX 78669  
Phone: 512-371-6159 | Fax: 512-351-8858  
For terms and conditions of sales, please visit:  
[www.abracon.com](http://www.abracon.com)

REVISED: 01.25.2019

ABRACON IS  
ISO9001-2015  
CERTIFIED

# 2x2 4G/LTE Screw Mount MIMO Antenna



AEACBK081014-M698



Ø81.6 x 14.5 mm  
RoHS/RoHS II Compliant  
MSL - 1

## Dimensions

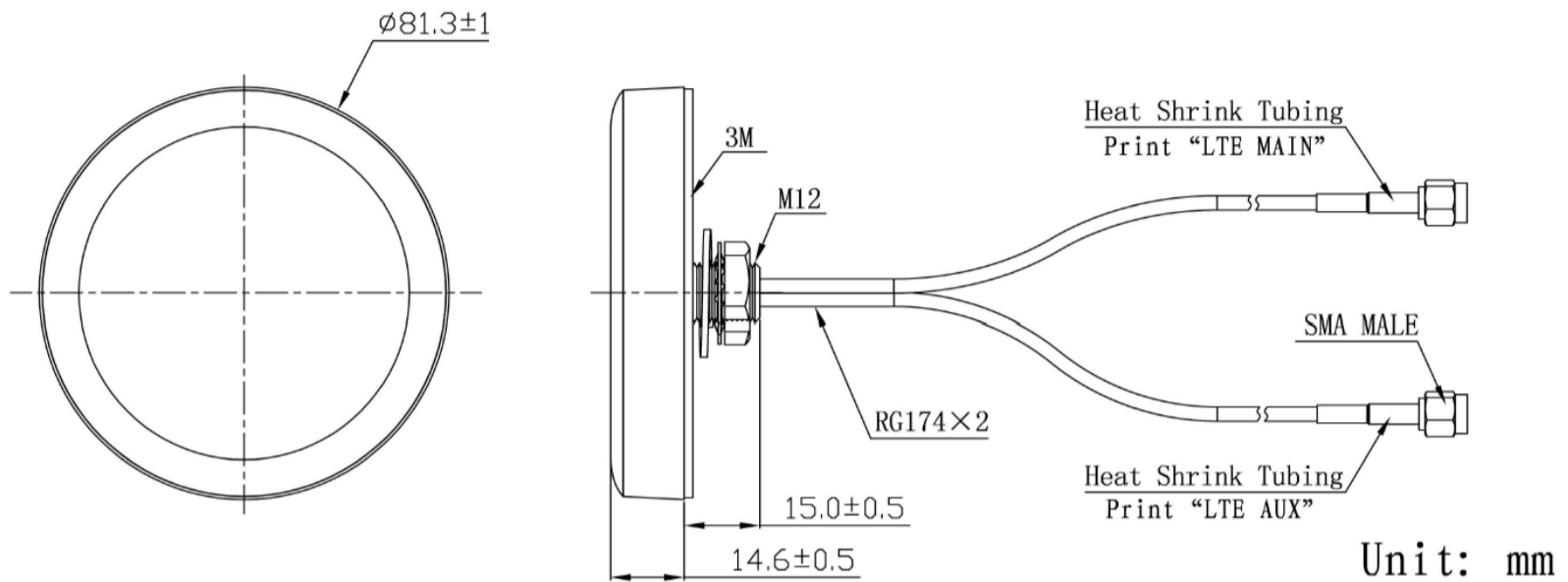

## Product Image



# 2x2 4G/LTE Screw Mount MIMO Antenna



AEACBK081014-M698



Ø81.6 x 14.5 mm  
RoHS/RoHS II Compliant  
MSL - 1

## VSWR

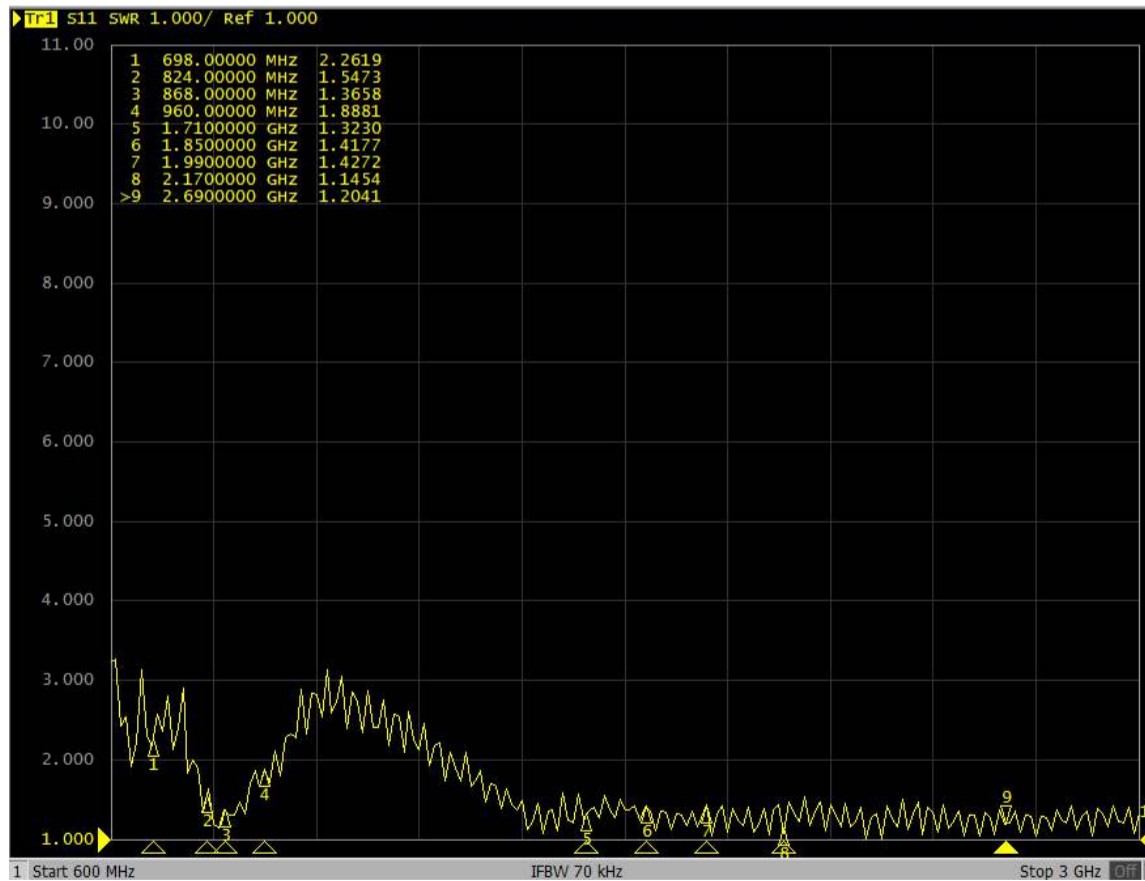
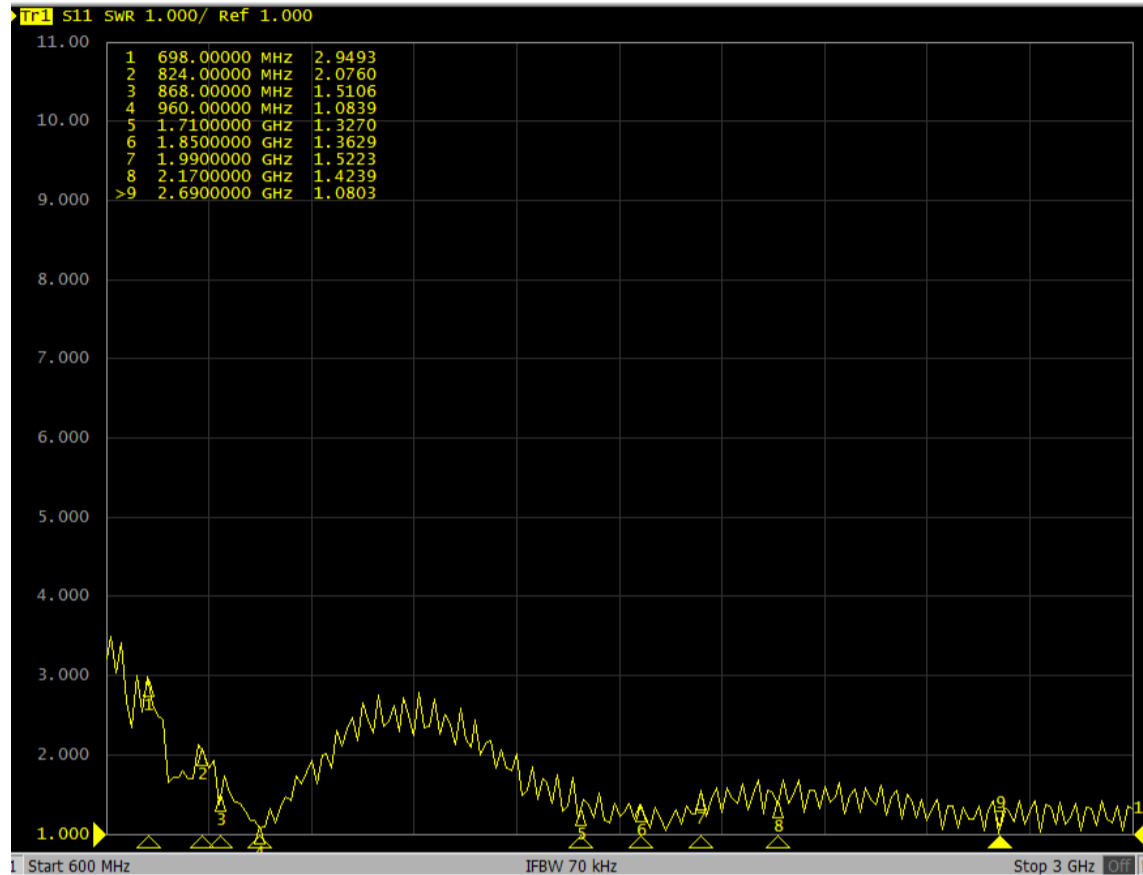

5101 Hidden Creek Ln Spicewood TX 78669  
Phone: 512-371-6159 | Fax: 512-351-8858  
For terms and conditions of sales, please visit:  
[www.abracon.com](http://www.abracon.com)

REVISED: 01.25.2019

ABRACON IS  
ISO9001-2015  
CERTIFIED

# 2x2 4G/LTE Screw Mount MIMO Antenna



AEACBK081014-M698



Ø81.6 x 14.5 mm  
RoHS/RoHS II Compliant  
MSL - 1

## Radiation Patterns

LTE Antenna MAIN

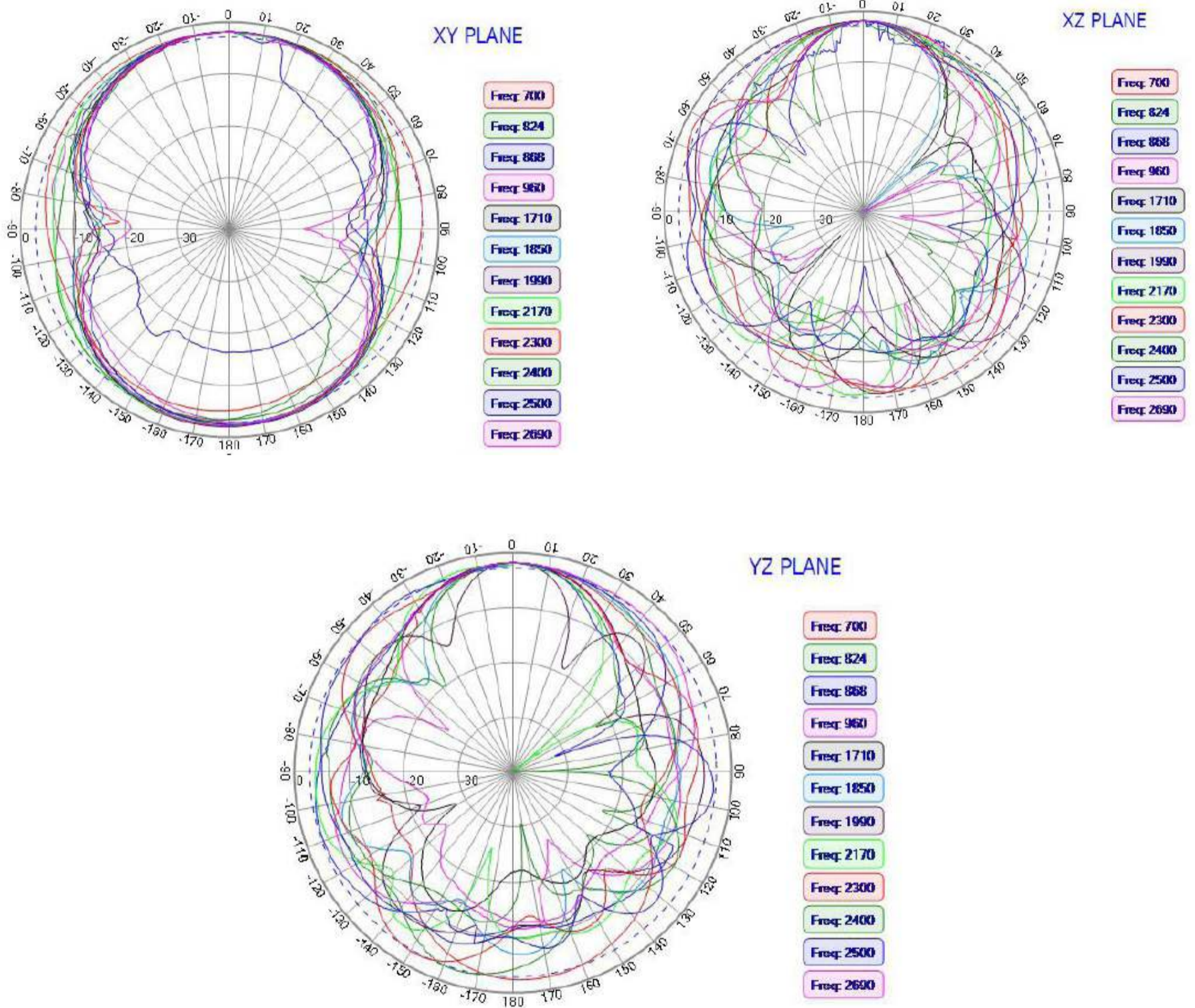

5101 Hidden Creek Ln Spicewood TX 78669  
Phone: 512-371-6159 | Fax: 512-351-8858  
For terms and conditions of sales, please visit:  
[www.abracon.com](http://www.abracon.com)

REVISED: 01.25.2019

ABRACON IS  
ISO9001-2015  
CERTIFIED



# 2x2 4G/LTE Screw Mount MIMO Antenna



AEACBK081014-M698



Ø81.6 x 14.5 mm  
RoHS/RoHS II Compliant  
MSL - 1

## Radiation Patterns

LTE Antenna AUX

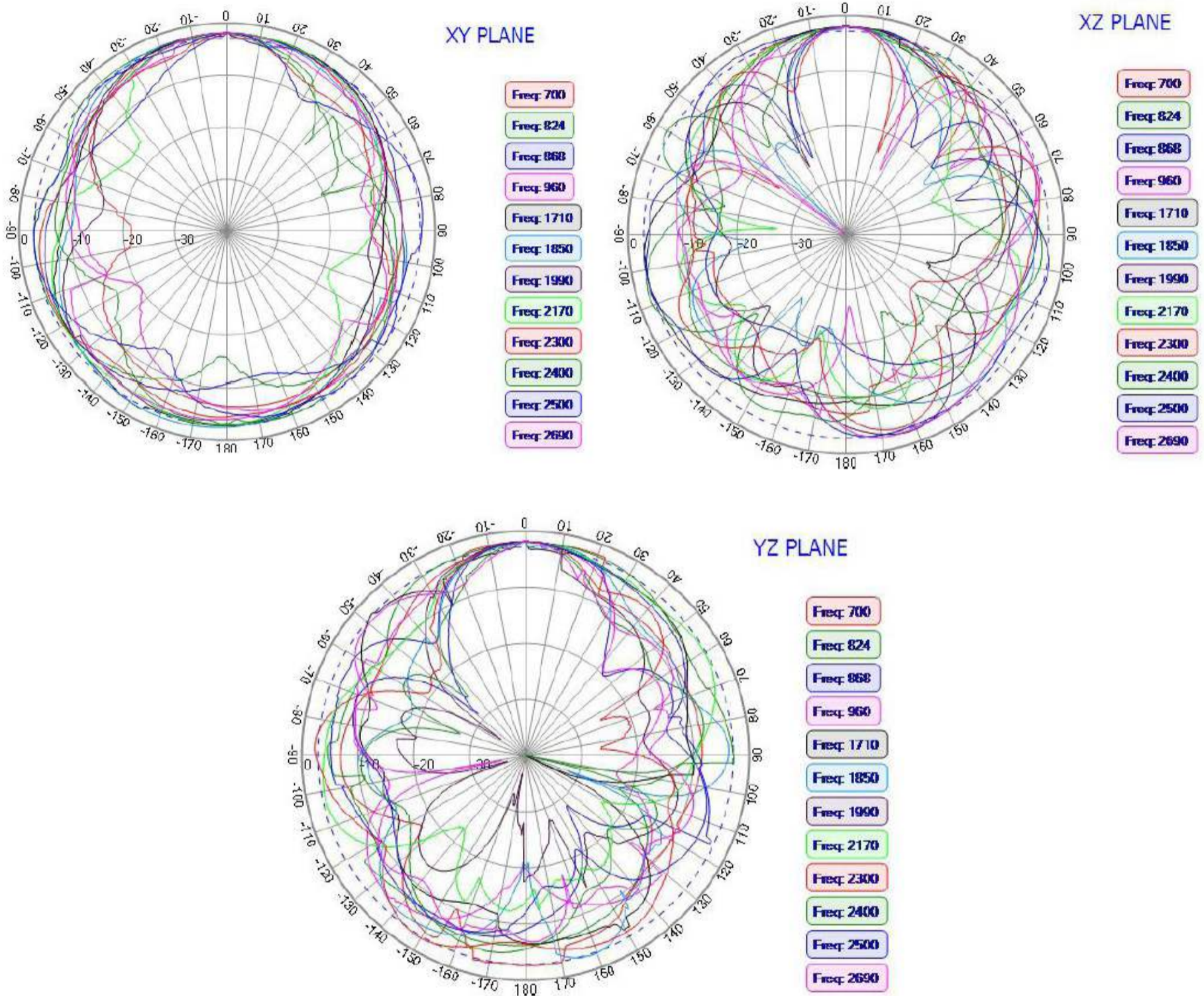

# 2x2 4G/LTE Screw Mount MIMO Antenna



AEACBK081014-M698



Ø81.6 x 14.5 mm  
RoHS/RoHS II Compliant  
MSL - 1

## Radiation Patterns

### 3D-Pattern

698 MHZ

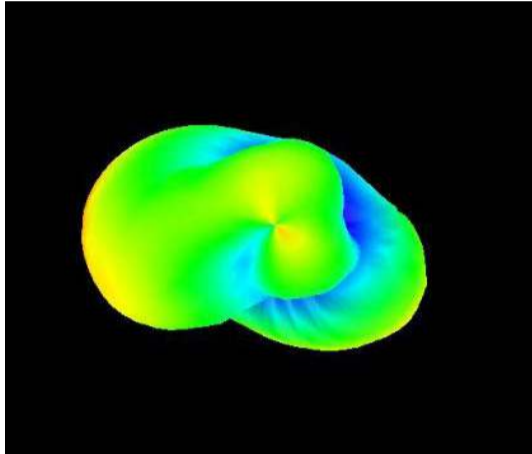

824 MHZ

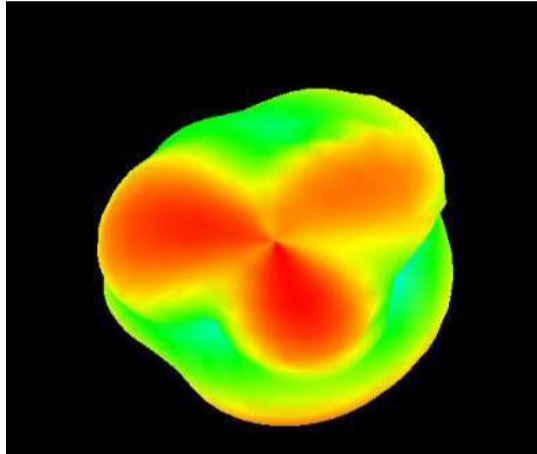

868 MHZ

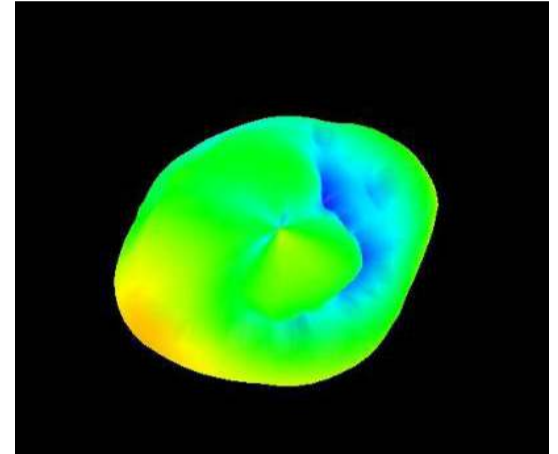

960 MHZ

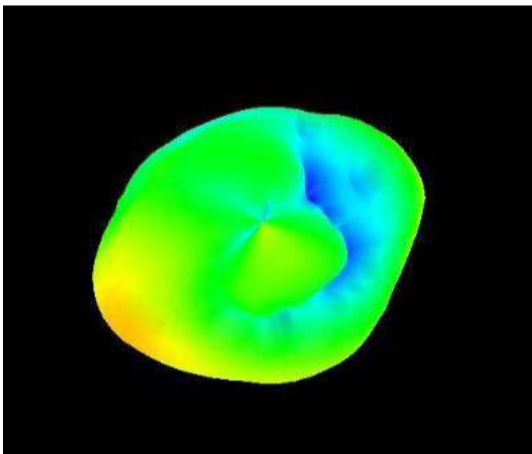

1710 MHZ

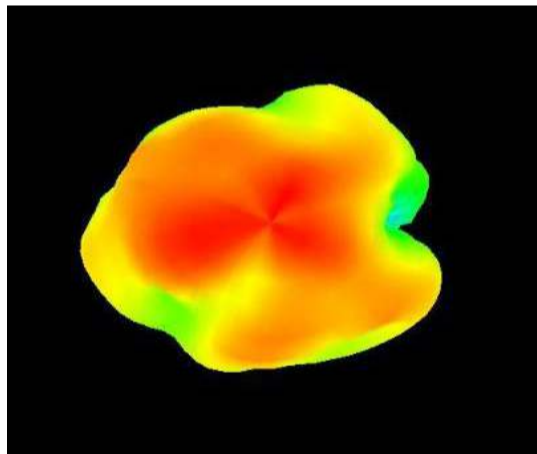

1850 MHZ

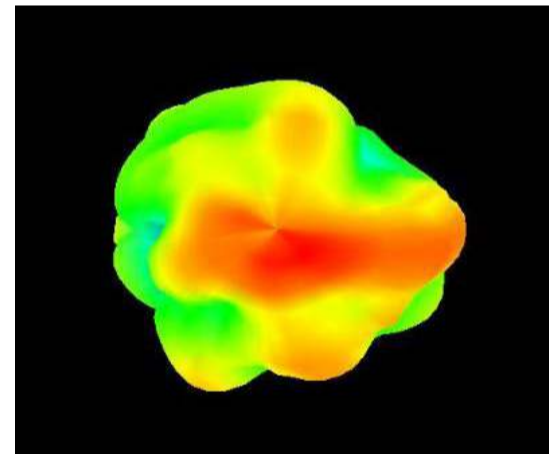

1990 MHZ

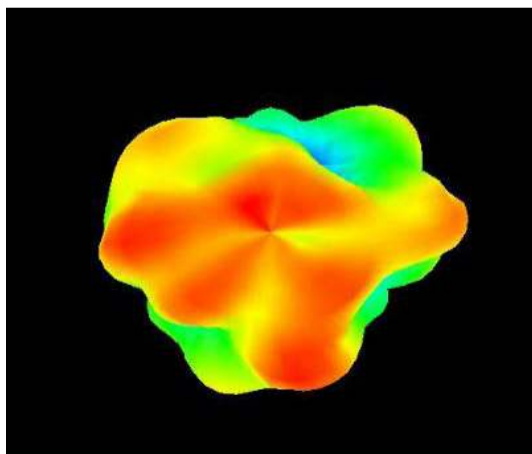

2170 MHZ

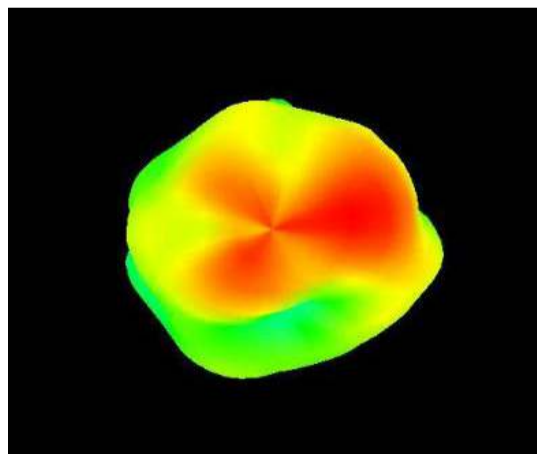

2690 MHZ

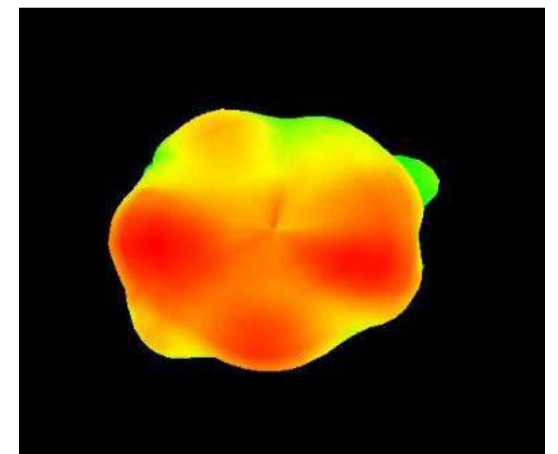

# 2x2 4G/LTE Screw Mount MIMO Antenna



AEACBK081014-M698



Ø81.6 x 14.5 mm  
RoHS/RoHS II Compliant  
MSL - 1

## Gain and Efficiency

### LTE Main:

Frequency (MHz)	Efficiency	Gain (dBi)
700	0.62	1.4
824	0.67	2.79
868	0.68	2.87
960	0.58	-0.71
1710	0.61	1.18
1850	0.57	-0.26
1990	0.61	1.1
2170	0.67	2.9
2690	0.59	1.07

### LTE Aux:

Frequency (MHz)	Efficiency	Gain (dBi)
700	0.62	1.5
824	0.64	1.74
868	0.68	2.75
960	0.58	0.55
1710	0.62	1.39
1850	0.57	0.51
1990	0.57	-0.23
2170	0.65	2.6
2690	0.56	0.62

## Packaging

Each 49.5 x 22.5 x 27.0 cm size carton includes 50 pcs antenna, weighs 7.5 kg.



5101 Hidden Creek Ln Spicewood TX 78669  
Phone: 512-371-6159 | Fax: 512-351-8858  
For terms and conditions of sales, please visit:  
[www.abracon.com](http://www.abracon.com)

REVISED: 01.25.2019

ABRACON IS  
ISO9001-2015  
CERTIFIED