

DS90LV019

DS90LV019 3.3V or 5V LVDS Driver/Receiver



Literature Number: SNLS008B

DS90LV019

3.3V or 5V LVDS Driver/Receiver

General Description

The DS90LV019 is a Driver/Receiver designed specifically for the high speed low power point-to-point interconnect applications. The device operates from a single 3.3V or 5.0V power supply and includes one differential line driver and one receiver. The DS90LV019 features an independent driver and receiver with TTL/CMOS compatibility (D_{IN} and R_{OUT}). The logic interface provides maximum flexibility as 4 separate lines are provided (D_{IN} , DE , \overline{RE} , and R_{OUT}). The device also features a flow-through pin out which allows easy PCB routing for short stubs between its pins and the connector. The driver has 3.5 mA output loop current.

The driver translates between TTL levels (single-ended) to Low Voltage Differential Signaling levels. This allows for high speed operation, while consuming minimal power with reduced EMI. In addition, the differential signaling provides common-mode noise rejection.

The receiver threshold is ± 100 mV over a $\pm 1V$ common-mode range and translates the low swing differential levels to standard (TTL/CMOS) levels.

Features

- LVDS Signaling
- 3.3V or 5.0V operation
- Low power CMOS design
- Balanced Output Impedance
- Glitch free power up/down (Driver disabled)
- High Signaling Rate Capacity (above 100 Mbps)
- Ultra Low Power Dissipation
- $\pm 1V$ Common-Mode Range
- ± 100 mV Receiver Sensitivity
- Product offered in SOIC and TSSOP packages
- Flow-Through Pin Out
- Industrial Temperature Range Operation

Connection Diagram

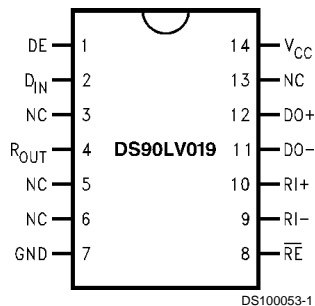

Order Number DS90LV019TM or DS90LV019TMTTC
See NS Package Number M14A or MTC14

Block Diagram

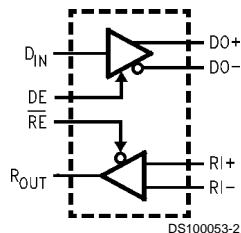

Absolute Maximum Ratings (Note 1)

If Military/Aerospace specified devices are required, please contact the National Semiconductor Sales Office/Distributors for availability and specifications.

Supply Voltage V_{CC}	6.0V
Enable Input Voltage (DE, \overline{RE})	-0.3V to ($V_{CC} + 0.3V$)
Driver Input Voltage (D_{IN})	-0.3V to ($V_{CC} + 0.3V$)
Receiver Output Voltage (R_{OUT})	-0.3V to ($V_{CC} + 0.3V$)
Driver Output Voltage (DO_{\pm})	-0.3V to +3.9V
Receiver Input Voltage (RI_{\pm})	-0.3V to ($V_{CC} + 0.3V$)
Driver Short Circuit Current	Continuous
ESD (Note 4)	
(HBM, 1.5 k Ω , 100 pF)	> 2.0 kV
(EIAJ, 0 Ω , 200 pF)	> 200 V
Maximum Package Power Dissipation at 25°C	
SOIC	960 mW

Derate SOIC Package	7.7mW/°C
TSSOP	790 mW
Derate TSSOP Package	6.3mW/°C
Storage Temperature Range	-65°C to +150°C
Lead Temperature (Soldering, 4 sec.)	260°C

Recommended Operating Conditions

	Min	Max	Units
Supply Voltage (V_{CC}) or	3.0	3.6	V
Supply Voltage (V_{CC})	4.5	5.5	V
Receiver Input Voltage	0.0	2.4	V
Operating Free Air Temperature T_A	-40	+85	°C

DC Electrical Characteristics

$T_A = -40^\circ\text{C}$ to $+85^\circ\text{C}$ unless otherwise noted, $V_{CC} = 3.3 \pm 0.3V$. (Notes 2, 3)

Symbol	Parameter	Conditions	Pin	Min	Typ	Max	Units	
DIFFERENTIAL DRIVER CHARACTERISTICS								
V_{OD}	Output Differential Voltage	$R_L = 100\Omega$ (Figure 1)	DO+, DO-	250	350	450	mV	
ΔV_{OD}	V_{OD} Magnitude Change				6	60	mV	
V_{OS}	Offset Voltage			1	1.25	1.7	V	
ΔV_{OS}	Offset Magnitude Change				5	60	mV	
I_{OZD}	TRI-STATE® Leakage			$V_{OUT} = V_{CC}$ or GND, DE = 0V	-10	± 1	+10	μA
I_{OXD}	Power-Off Leakage			$V_{OUT} = 3.6V$ or GND, $V_{CC} = 0V$	-10	± 1	+10	μA
I_{OSD}	Output Short Circuit Current	$V_{OUT} = 0V$, DE = V_{CC}	-10	-6	-4	mA		
DIFFERENTIAL RECEIVER CHARACTERISTICS								
V_{OH}	Voltage Output High	VID = +100 mV	R_{OUT}	2.9	3.3		V	
		Inputs Open		2.9	3.3		V	
V_{OL}	Voltage Output Low	$I_{OL} = 2.0$ mA, VID = -100 mV			0.1	0.4	V	
I_{OS}	Output Short Circuit Current	$V_{OUT} = 0V$		-75	-34	-20	mA	
V_{TH}	Input Threshold High		RI+, RI-			+100	mV	
V_{TH}	Input Threshold Low			-100			mV	
I_{IN}	Input Current	$V_{IN} = +2.4V$ or 0V, $V_{CC} = 3.6V$ or 0V		-10	± 1	+10	μA	
DEVICE CHARACTERISTICS								
V_{IH}	Minimum Input High Voltage		D_{IN} , DE, \overline{RE}	2.0		V_{CC}	V	
V_{IL}	Maximum Input Low Voltage			GND		0.8	V	
I_{IH}	Input High Current	$V_{IN} = V_{CC}$ or 2.4V			± 1	± 10	μA	
I_{IL}	Input Low Current	$V_{IN} = GND$ or 0.4V			± 1	± 10	μA	
V_{CL}	Input Diode Clamp Voltage	$I_{CLAMP} = -18$ mA			-1.5	-0.7	V	
I_{CCD}	Power Supply Current	DE = $\overline{RE} = V_{CC}$	V_{CC}		9	12.5	mA	
I_{CCR}		DE = $\overline{RE} = 0V$			4.5	7.0	mA	
I_{CCZ}		DE = 0V, $\overline{RE} = V_{CC}$			3.7	7.0	mA	
I_{CC}		DE = V_{CC} , $\overline{RE} = 0V$			15	20	mA	
$C_{D\text{ output}}$	Capacitance		DO+, DO-		5		pF	
$C_{R\text{ input}}$	Capacitance		RI+, RI-		5		pF	

DC Electrical Characteristics

$T_A = -40^\circ\text{C}$ to $+85^\circ\text{C}$ unless otherwise noted, $V_{CC} = 5.0 \pm 0.5\text{V}$. (Notes 2, 3)

Symbol	Parameter	Conditions	Pin	Min	Typ	Max	Units	
DIFFERENTIAL DRIVER CHARACTERISTICS								
V_{OD}	Output Differential Voltage	$R_L = 100\Omega$ (Figure 1)	DO+, DO-	250	360	450	mV	
ΔV_{OD}	V_{OD} Magnitude Change				6	60	mV	
V_{OS}	Offset Voltage			1	1.25	1.8	V	
ΔV_{OS}	Offset Magnitude Change				5	60	mV	
I_{OZD}	TRI-STATE Leakage			$V_{OUT} = V_{CC}$ or GND, DE = 0V	-10	± 1	+10	μA
I_{OXD}	Power-Off Leakage			$V_{OUT} = 5.5\text{V}$ or GND, $V_{CC} = 0\text{V}$	-10	± 1	+10	μA
I_{OSD}	Output Short Circuit Current			$V_{OUT} = 0\text{V}$, DE = V_{CC}	-10	-6	-4	mA
DIFFERENTIAL RECEIVER CHARACTERISTICS								
V_{OH}	Voltage High	VID = +100 mV	$I_{OH} = -400 \mu\text{A}$	R_{OUT}	4.3	5.0		V
		Inputs Open			4.3	5.0		V
V_{OL}	Voltage Output Low	$I_{OL} = 2.0 \text{ mA}$, VID = -100 mV			0.1	0.4	V	
I_{OS}	Output Short Circuit Current	$V_{OUT} = 0\text{V}$			-150	-75	-40	mA
V_{TH}	Input Threshold High			RI+, RI-			+100	mV
V_{TH}	Input Threshold Low							-100
I_{IN}	Input Current	$V_{IN} = +2.4\text{V}$ or 0V, $V_{CC} = 5.5\text{V}$ or 0V			-15	± 1	+15	μA
DEVICE CHARACTERISTICS								
V_{IH}	Minimum Input High Voltage			$D_{IN},$ DE, \overline{RE}	2.0		V_{CC}	V
V_{IL}	Maximum Input Low Voltage				GND		0.8	V
I_{IH}	Input High Current	$V_{IN} = V_{CC}$ or 2.4 V				± 1	± 10	μA
I_{IL}	Input Low Current	$V_{IN} = \text{GND}$ or 0.4V				± 1	± 10	μA
V_{CL}	Input Diode Clamp Voltage	$I_{CLAMP} = -18 \text{ mA}$			-1.5	-0.8		V
I_{CCD}	Power Supply Current	DE = $\overline{RE} = V_{CC}$		V_{CC}		12	19	mA
I_{CCR}		DE = $\overline{RE} = 0\text{V}$				5.8	8	mA
I_{CCZ}		DE = 0V, $\overline{RE} = V_{CC}$				4.5	8.5	mA
I_{CC}		DE = V_{CC} , $\overline{RE} = 0\text{V}$				18	48	mA
$C_{D \text{ output}}$	Capacitance			DO+, DO-		5		pF
$C_{R \text{ input}}$	Capacitance			RI+, RI-		5		pF

Note 1: "Absolute Maximum Ratings" are these beyond which the safety of the device cannot be guaranteed. They are not meant to imply that the device should be operated at these limits. The table of "Electrical Characteristics" provides conditions for actual device operation.

Note 2: All currents into device pins are positive; all currents out of device pins are negative. All voltages are referenced to device ground unless otherwise specified.

Note 3: All typicals are given for $V_{CC} = +3.3\text{V}$ or $+5.0\text{V}$ and $T_A = +25^\circ\text{C}$, unless otherwise stated.

Note 4: ESD Rating:

HBM (1.5 k Ω , 100 pF) > 2.0 kV

EIAJ (0 Ω , 200 pF) > 200V.

Note 5: C_L includes probe and fixture capacitance.

Note 6: Generator waveforms for all tests unless otherwise specified; $f = 1 \text{ MHz}$, $Z_O = 50\Omega$, $t_r = t_f \leq 6.0 \text{ ns}$ (0%–100%).

AC Electrical Characteristics

$T_A = -40^\circ\text{C}$ to $+85^\circ\text{C}$, $V_{CC} = 3.3\text{V} \pm 0.3\text{V}$. (Note 6)

Symbol	Parameter	Conditions	Min	Typ	Max	Units
DRIVER TIMING REQUIREMENTS						
t_{PHLD}	Differential Propagation Delay High to Low	$R_L = 100\Omega$, $C_L = 10 \text{ pF}$ (Figure 2 and Figure 3)	2.0	4.0	6.5	ns
t_{PLHD}	Differential Propagation Delay Low to High		1.0	5.6	7.0	ns
t_{SKD}	Differential Skew $ t_{PHLD} - t_{PLHD} $			0.4	1.0	ns
t_{TLH}	Transition Time Low to High		0.2	0.7	3.0	ns
t_{THL}	Transition Time High to Low		0.2	0.8	3.0	ns

AC Electrical Characteristics (Continued) $T_A = -40^{\circ}\text{C}$ to $+85^{\circ}\text{C}$, $V_{CC} = 3.3\text{V} \pm 0.3\text{V}$. (Note 6)

Symbol	Parameter	Conditions	Min	Typ	Max	Units
DRIVER TIMING REQUIREMENTS						
t_{PHZ}	Disable Time High to Z	$R_L = 100\Omega$, $C_L = 10\text{ pF}$ (Figure 4 and Figure 5)	1.5	4.0	8.0	ns
t_{PLZ}	Disable Time Low to Z		2.5	5.3	9.0	ns
t_{PZH}	Enable Time Z to High		4.0	6.0	8.0	ns
t_{PZL}	Enable Time Z to Low		3.5	6.0	8.0	ns
RECEIVER TIMING REQUIREMENTS						
t_{PHLD}	Differential Propagation Delay High to Low	$C_L = 10\text{ pF}$, $VID = 200\text{ mV}$ (Figure 6 and Figure 7)	3.0	5.8	7.0	ns
t_{PLHD}	Differential Propagation Delay Low to High		3.0	5.6	9.0	ns
t_{SKD}	Differential Skew $ t_{PHLD} - t_{PLHD} $			0.55	1.5	ns
t_r	Rise Time		0.15	2.0	3.0	ns
t_f	Fall Time		0.15	0.9	3.0	ns
t_{PHZ}	Disable Time High to Z	$R_L = 500\Omega$, $C_L = 10\text{ pF}$ (Figure 8 and Figure 9)	3.0	4.0	6.0	ns
t_{PLZ}	Disable Time Low to Z		3.0	4.5	6.0	ns
t_{PZH}	Enable Time Z to High		3.0	6.0	8.0	ns
t_{PZL}	Enable Time Z to Low		3.0	6.0	8.0	ns

AC Electrical Characteristics $T_A = -40^{\circ}\text{C}$ to $+85^{\circ}\text{C}$, $V_{CC} = 5.0\text{V} \pm 0.5\text{V}$. (Note 6)

Symbol	Parameter	Conditions	Min	Typ	Max	Units
DRIVER TIMING REQUIREMENTS						
t_{PHLD}	Differential Propagation Delay High to Low	$R_L = 100\Omega$, $C_L = 10\text{ pF}$ (Figure 2 and Figure 3)	2.0	3.3	6.0	ns
t_{PLHD}	Differential Propagation Delay Low to High		1.0	3.3	5.0	ns
t_{SKD}	Differential Skew $ t_{PHLD} - t_{PLHD} $			0.6	1.0	ns
t_{TLH}	Transition Time Low to High		0.15	0.9	3.0	ns
t_{THL}	Transition Time High to Low		0.15	1.2	3.0	ns
t_{PHZ}	Disable Time High to Z	$R_L = 100\Omega$, $C_L = 10\text{ pF}$ (Figure 4 and Figure 5)	1.5	3.5	7.0	ns
t_{PLZ}	Disable Time Low to Z		3.0	5.2	9.0	ns
t_{PZH}	Enable Time Z to High		2.0	4.5	7.0	ns
t_{PZL}	Enable Time Z to Low		2.0	4.5	7.0	ns
RECEIVER TIMING REQUIREMENTS						
t_{PHLD}	Differential Propagation Delay High to Low	$C_L = 10\text{ pF}$, $VID = 200\text{ mV}$ (Figure 6 and Figure 7)	3.0	6.0	8.0	ns
t_{PLHD}	Differential Propagation Delay Low to High		3.0	5.6	8.0	ns
t_{SKD}	Differential Skew $ t_{PHLD} - t_{PLHD} $			0.7	1.6	ns
t_r	Rise Time		0.15	0.8	3.0	ns
t_f	Fall Time		0.15	0.8	3.0	ns
t_{PHZ}	Disable Time High to Z	$R_L = 500\Omega$, $C_L = 10\text{ pF}$ (Figure 8 and Figure 9)	3.0	3.5	4.5	ns
t_{PLZ}	Disable Time Low to Z		3.5	3.6	7.0	ns
t_{PZH}	Enable Time Z to High		3.0	5.0	7.0	ns
t_{PZL}	Enable Time Z to Low		3.0	5.0	7.0	ns

Test Circuits and Timing Waveforms

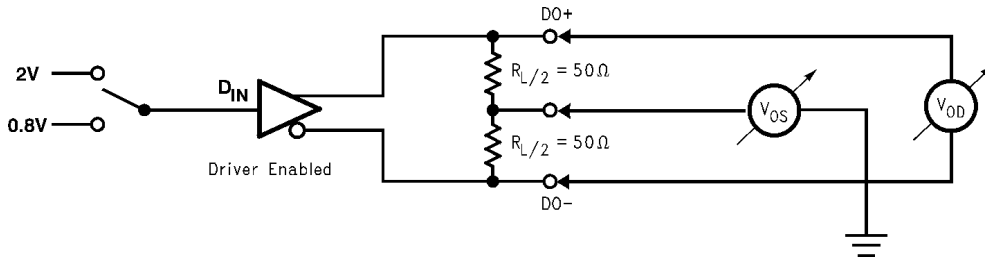

DS100053-3

FIGURE 1. Differential Driver DC Test Circuit

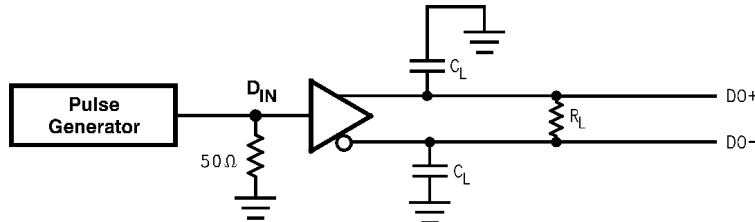

DS100053-4

FIGURE 2. Differential Driver Propagation Delay and Transition Test Circuit

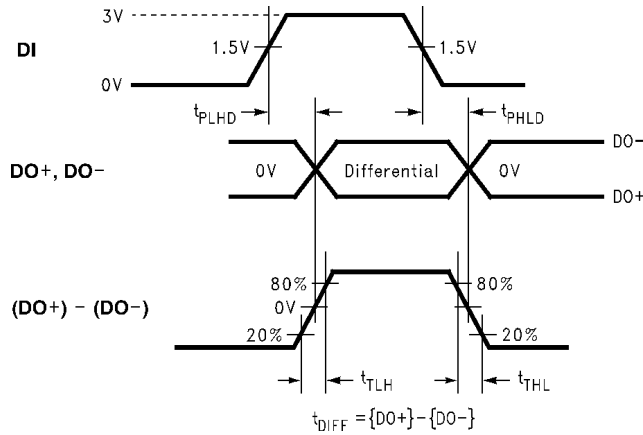

DS100053-5

FIGURE 3. Differential Driver Propagation and Transition Time Waveforms

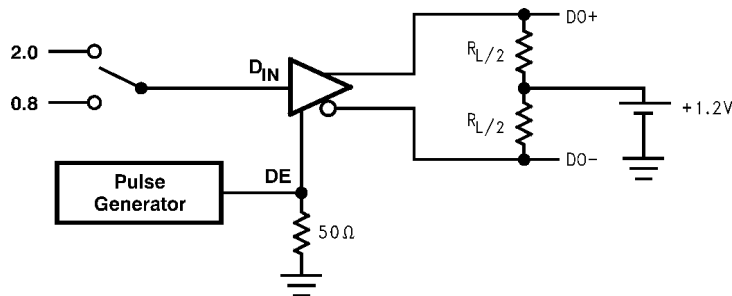

DS100053-6

FIGURE 4. Driver TRI-STATE Delay Test Circuit

Test Circuits and Timing Waveforms (Continued)

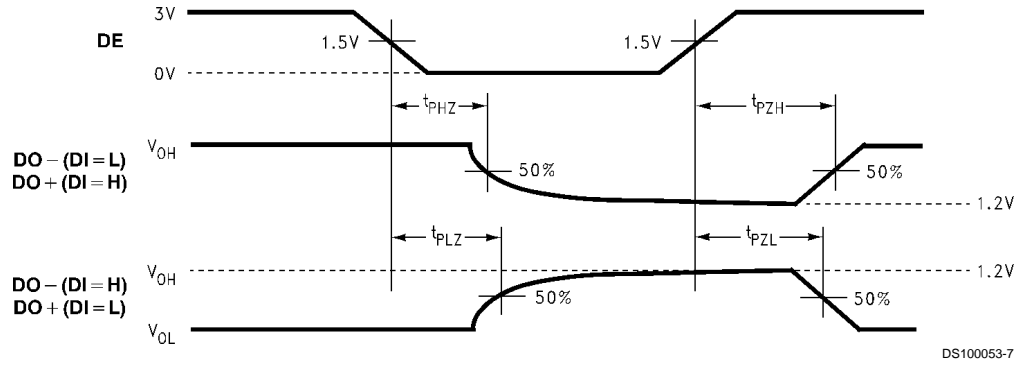

FIGURE 5. Driver TRI-STATE Delay Waveforms

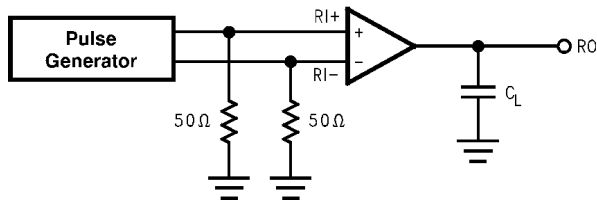

FIGURE 6. Receiver Propagation Delay and Transition Time Test Circuit

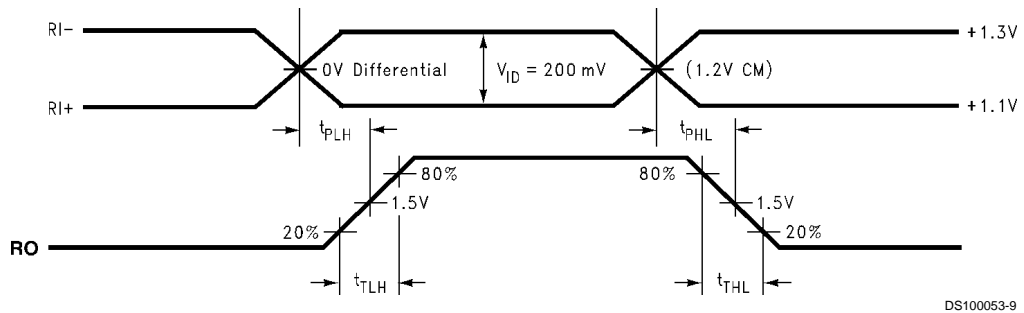

FIGURE 7. Receiver Propagation Delay and Transition Time Waveforms

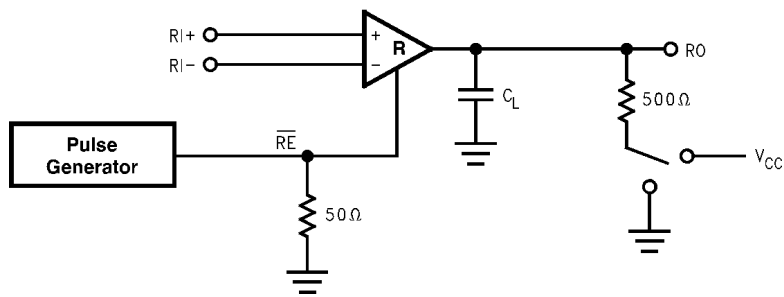

FIGURE 8. Receiver TRI-STATE Delay Test Circuit

Test Circuits and Timing Waveforms (Continued)

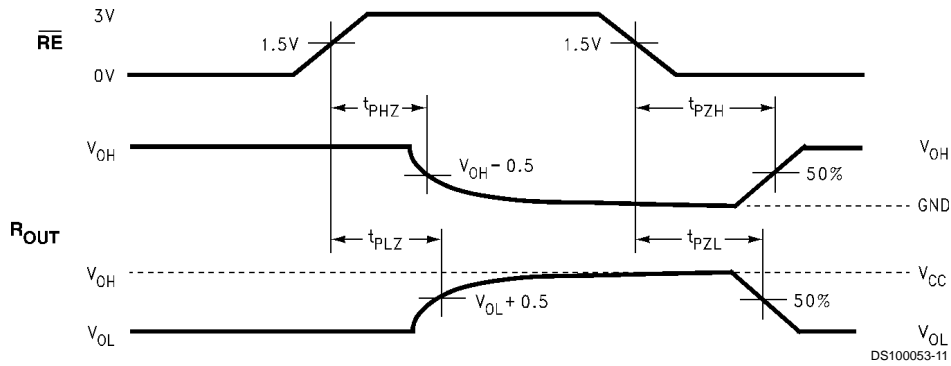
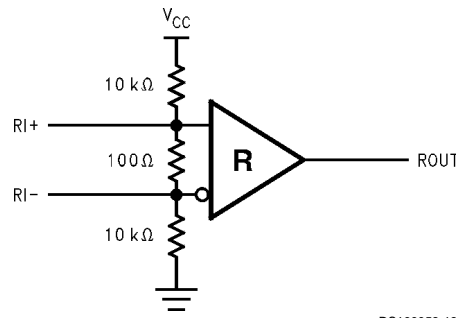

FIGURE 9. Receiver TRI-STATE Delay Waveforms



DS100053-13

FIGURE 10. Terminated Input Fail-Safe Circuit

Typical Application Diagram

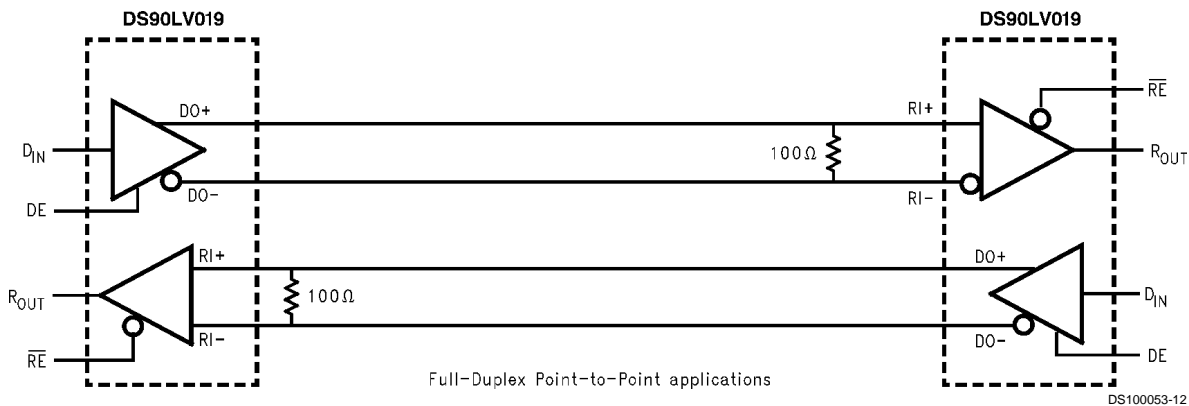

Applications Information

The DS90LV019 has two control pins, which allows the device to operate as a driver, a receiver or both driver and a receiver at the same time. There are a few common practices which should be implied when designing PCB for LVDS signaling. Recommended practices are:

- Use at least 4 PCB board layer (LVDS signals, ground, power and TTL signals).
- Keep drivers and receivers as close to the (LVDS port side) connector as possible.
- Bypass each LVDS device and also use distributed bulk capacitance. Surface mount capacitors placed close to power and ground pins work best. Two or three multi-layer ceramic (MLC) surface mount capacitors 0.1 μF ,

and 0.01 μF in parallel should be used between each V_{CC} and ground. The capacitors should be as close as possible to the V_{CC} pin.

- Use controlled impedance traces which match the differential impedance of your transmission medium (i.e., Cable) and termination resistor.
- Use the termination resistor which best matches the differential impedance of your transmission line.
- Isolate TTL signals from LVDS signals.

MEDIA (CABLE AND CONNECTOR) SELECTION:

- Use controlled impedance media. The cables and connectors should have a matched differential impedance of about 100 Ω .

Applications Information (Continued)

- Balanced cables (e.g., twisted pair) are usually better than unbalanced cables (ribbon cable, simple coax) for noise reduction and signal quality.
- For cable distances $< 0.5\text{m}$, most cables can be made to work effectively. For distances $0.5\text{m} \leq d \leq 10\text{m}$, CAT 3 (category 3) twisted pair cable works well and is readily available and relatively inexpensive. For distances $> 10\text{m}$, and high data rates CAT 5 twisted pair is recommended.
- There are three Fail-Safe scenarios, open input pins, shorted inputs pins and terminated input pins. The first case is guaranteed for DS90LV019. A HIGH state on R_{OUT} pin can be achieved by using two external resistors (one to V_{CC} and one to GND) per *Figure 10* (Terminated Input Fail-Safe Circuit). R_1 and R_2 should be R_T to limit the loading to the LVDS driver. R_T is selected to match the impedance of the cable.

TABLE 1. Functional Table

MODE SELECTED	DE	\overline{RE}
DRIVER MODE	H	H
RECEIVER MODE	L	L
TRI-STATE MODE	L	H
FULL DUPLEX MODE	H	L

TABLE 2. Transmitter Mode

INPUTS		OUTPUTS	
DE	DI	DO+	DO-
H	L	L	H
H	H	H	L
H	$2 > \& > 0.8$	X	X
L	X	Z	Z

X = High or Low logic state
 Z = High impedance state
 L = Low state
 H = High state

TABLE 3. Receiver Mode

INPUTS		OUTPUT
\overline{RE}	(RI+) – (RI-)	
L	L ($< -100\text{mV}$)	L
L	H ($> +100\text{mV}$)	H
L	$100\text{mV} > \& > -100\text{mV}$	X
H	X	Z

X = High or Low logic state
 Z = High impedance state
 L = Low state
 H = High state

TABLE 4. Device Pin Description

Pin Name	Pin #	Input/Output	Description
D_{IN}	2	I	TTL Driver Input
DO_{\pm}	11, 12	O	LVDS Driver Outputs
RI_{\pm}	9, 10	I	LVDS Receiver Inputs
R_{OUT}	4	O	TTL Receiver Output
\overline{RE}	8	I	Receiver Enable TTL Input (Active Low)
DE	1	I	Driver Enable TTL Input (Active High)
GND	7	NA	Ground
V_{CC}	14	NA	Power Supply ($3.3\text{V} \pm 0.3\text{V}$ or $5.0\text{V} \pm 0.5\text{V}$)

Physical Dimensions inches (millimeters) unless otherwise noted

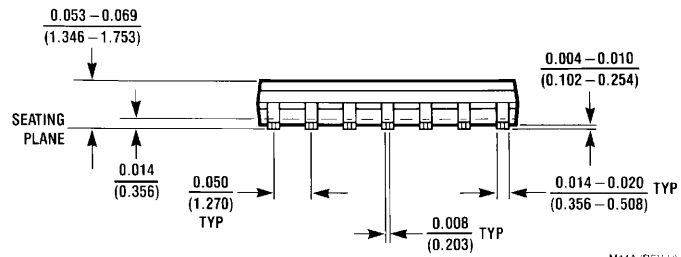
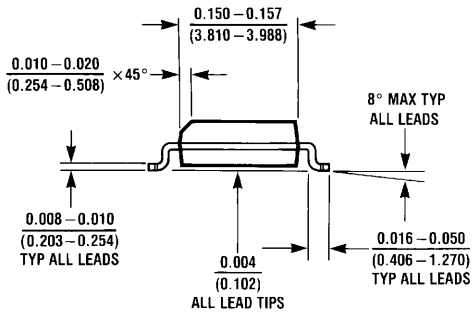
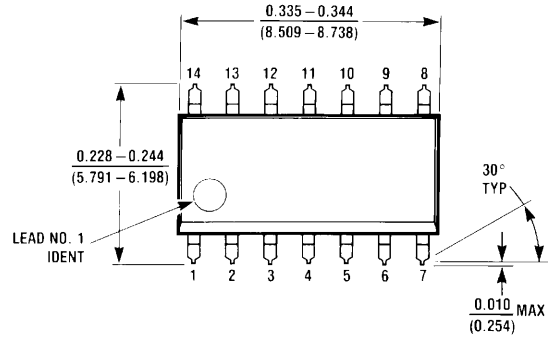

M14A (REV H)

Order Number DS90LV019TM
NS Package Number M14A

Physical Dimensions inches (millimeters) unless otherwise noted (Continued)

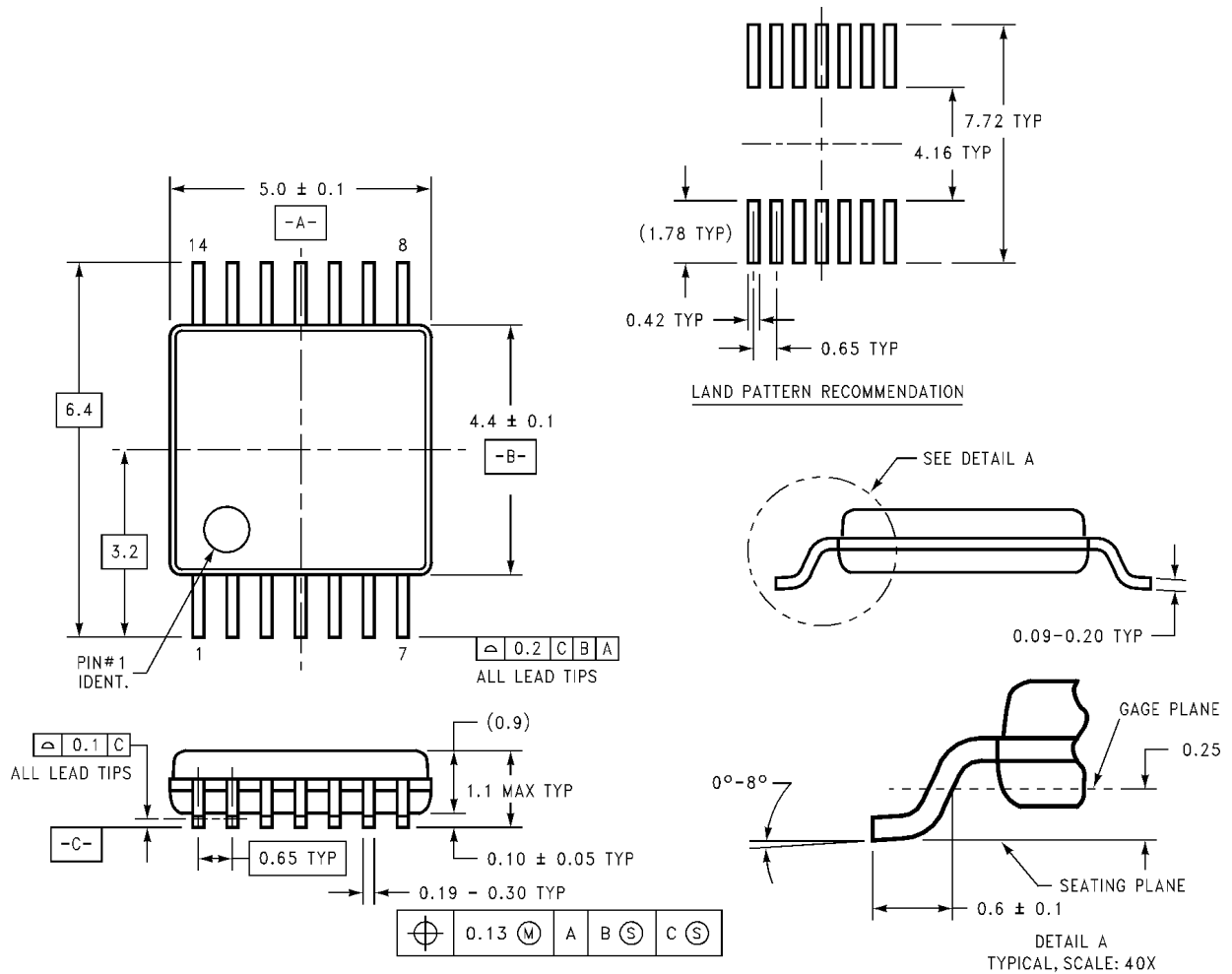

DIMENSIONS ARE IN MILLIMETERS

MTC14 (REV C)

Order Number DS90LV019TMTc
NS Package Number MTC14

LIFE SUPPORT POLICY

NATIONAL'S PRODUCTS ARE NOT AUTHORIZED FOR USE AS CRITICAL COMPONENTS IN LIFE SUPPORT DEVICES OR SYSTEMS WITHOUT THE EXPRESS WRITTEN APPROVAL OF THE PRESIDENT AND GENERAL COUNSEL OF NATIONAL SEMICONDUCTOR CORPORATION. As used herein:

1. Life support devices or systems are devices or systems which, (a) are intended for surgical implant into the body, or (b) support or sustain life, and whose failure to perform when properly used in accordance with instructions for use provided in the labeling, can be reasonably expected to result in a significant injury to the user.
2. A critical component is any component of a life support device or system whose failure to perform can be reasonably expected to cause the failure of the life support device or system, or to affect its safety or effectiveness.

 **National Semiconductor Corporation**
 Americas
 Tel: 1-800-272-9959
 Fax: 1-800-737-7018
 Email: support@nsc.com
 www.national.com

National Semiconductor Europe
 Fax: +49 (0) 180-530 85 86
 Email: europe.support@nsc.com
 Deutsch Tel: +49 (0) 69 9508 6208
 English Tel: +44 (0) 870 24 0 2171
 Français Tel: +33 (0) 1 41 91 8790

National Semiconductor Asia Pacific Customer Response Group
 Tel: 65-2544466
 Fax: 65-2504466
 Email: ap.support@nsc.com

National Semiconductor Japan Ltd.
 Tel: 81-3-5639-7560
 Fax: 81-3-5639-7507

IMPORTANT NOTICE

Texas Instruments Incorporated and its subsidiaries (TI) reserve the right to make corrections, modifications, enhancements, improvements, and other changes to its products and services at any time and to discontinue any product or service without notice. Customers should obtain the latest relevant information before placing orders and should verify that such information is current and complete. All products are sold subject to TI's terms and conditions of sale supplied at the time of order acknowledgment.

TI warrants performance of its hardware products to the specifications applicable at the time of sale in accordance with TI's standard warranty. Testing and other quality control techniques are used to the extent TI deems necessary to support this warranty. Except where mandated by government requirements, testing of all parameters of each product is not necessarily performed.

TI assumes no liability for applications assistance or customer product design. Customers are responsible for their products and applications using TI components. To minimize the risks associated with customer products and applications, customers should provide adequate design and operating safeguards.

TI does not warrant or represent that any license, either express or implied, is granted under any TI patent right, copyright, mask work right, or other TI intellectual property right relating to any combination, machine, or process in which TI products or services are used. Information published by TI regarding third-party products or services does not constitute a license from TI to use such products or services or a warranty or endorsement thereof. Use of such information may require a license from a third party under the patents or other intellectual property of the third party, or a license from TI under the patents or other intellectual property of TI.

Reproduction of TI information in TI data books or data sheets is permissible only if reproduction is without alteration and is accompanied by all associated warranties, conditions, limitations, and notices. Reproduction of this information with alteration is an unfair and deceptive business practice. TI is not responsible or liable for such altered documentation. Information of third parties may be subject to additional restrictions.

Resale of TI products or services with statements different from or beyond the parameters stated by TI for that product or service voids all express and any implied warranties for the associated TI product or service and is an unfair and deceptive business practice. TI is not responsible or liable for any such statements.

TI products are not authorized for use in safety-critical applications (such as life support) where a failure of the TI product would reasonably be expected to cause severe personal injury or death, unless officers of the parties have executed an agreement specifically governing such use. Buyers represent that they have all necessary expertise in the safety and regulatory ramifications of their applications, and acknowledge and agree that they are solely responsible for all legal, regulatory and safety-related requirements concerning their products and any use of TI products in such safety-critical applications, notwithstanding any applications-related information or support that may be provided by TI. Further, Buyers must fully indemnify TI and its representatives against any damages arising out of the use of TI products in such safety-critical applications.

TI products are neither designed nor intended for use in military/aerospace applications or environments unless the TI products are specifically designated by TI as military-grade or "enhanced plastic." Only products designated by TI as military-grade meet military specifications. Buyers acknowledge and agree that any such use of TI products which TI has not designated as military-grade is solely at the Buyer's risk, and that they are solely responsible for compliance with all legal and regulatory requirements in connection with such use.

TI products are neither designed nor intended for use in automotive applications or environments unless the specific TI products are designated by TI as compliant with ISO/TS 16949 requirements. Buyers acknowledge and agree that, if they use any non-designated products in automotive applications, TI will not be responsible for any failure to meet such requirements.

Following are URLs where you can obtain information on other Texas Instruments products and application solutions:

Products

Audio	www.ti.com/audio
Amplifiers	amplifier.ti.com
Data Converters	dataconverter.ti.com
DLP® Products	www.dlp.com
DSP	dsp.ti.com
Clocks and Timers	www.ti.com/clocks
Interface	interface.ti.com
Logic	logic.ti.com
Power Mgmt	power.ti.com
Microcontrollers	microcontroller.ti.com
RFID	www.ti-rfid.com
OMAP Mobile Processors	www.ti.com/omap
Wireless Connectivity	www.ti.com/wirelessconnectivity

Applications

Communications and Telecom	www.ti.com/communications
Computers and Peripherals	www.ti.com/computers
Consumer Electronics	www.ti.com/consumer-apps
Energy and Lighting	www.ti.com/energy
Industrial	www.ti.com/industrial
Medical	www.ti.com/medical
Security	www.ti.com/security
Space, Avionics and Defense	www.ti.com/space-avionics-defense
Transportation and Automotive	www.ti.com/automotive
Video and Imaging	www.ti.com/video

TI E2E Community Home Page

e2e.ti.com

Mailing Address: Texas Instruments, Post Office Box 655303, Dallas, Texas 75265
Copyright © 2011, Texas Instruments Incorporated