

HIGH VOLTAGE RECTIFIER

VOLTAGE RANGE 1200 to 2000 Volts CURRENT 0.2 to 0.5 Ampere

FEATURES

- * Low cost
- * Low leakage
- * Low forward voltage drop
- * High current capability

MECHANICAL DATA

- * Case: Molded plastic
- * Epoxy: Device has UL flammability classification 94V-0
- * Lead: MIL-STD-202E method 208C guaranteed
- * Mounting position: Any

MAXIMUM RATINGS AND ELECTRICAL CHARACTERISTICS

Ratings at 25 °C ambient temperature unless otherwise specified.
Single phase, half wave, 60 Hz, resistive or inductive load.
For capacitive load, derate current by 20%.

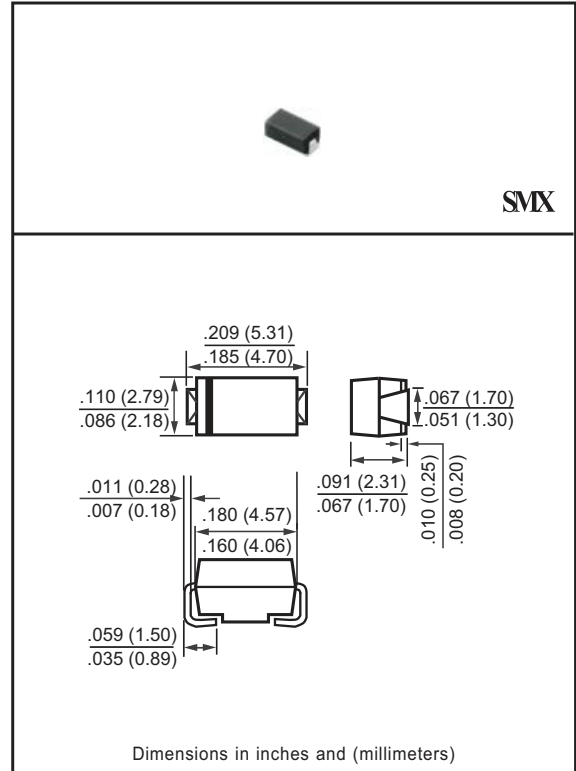

MAXIMUM RATINGS (At TA = 25°C unless otherwise noted)

RATINGS	SYMBOL	FM1200W	FM1500W	FM1800W	FM2000W	UNITS
Maximum Recurrent Peak Reverse Voltage	VRRM	1200	1500	1800	2000	Volts
Maximum RMS Volts	VRMS	840	1050	1260	1400	Volts
Maximum DC Blocking Voltage	Vdc	1200	1500	1800	2000	Volts
Maximum Average Forward Rectified Current at TA = 50°C	Io	500			200	mAmps
Peak Forward Surge Current, 8.3 ms single half sine-wave superimposed on rated load (JEDEC method)	IFSM	25				Amps
Typical Current Squared Time	I ² T	2.59				A ² S
Typical Junction Capacitance (Note)	CJ	35				pF
Operating and Storage Temperature Range	TJ, TSTG	-55 to + 150				°C

ELECTRICAL CHARACTERISTICS (At TA = 25°C unless otherwise noted)

CHARACTERISTICS	SYMBOL	FM1200W	FM1500W	FM1800W	FM2000W	UNITS
Maximum Instantaneous Forward Voltage at 0.5A/0.2A DC	VF	2.0			3.0	Volts
Maximum DC Reverse Current at Rated DC Blocking Voltage	@TA = 25°C	5.0				uAmps
	@TA = 125°C	50				
Maximum Full Load Reverse Current Average, Full Cycle .375", (9.5mm) lead length at TL = 75°C		30				uAmps

NOTES : Measured at 1 MHz and applied reverse voltage of 4.0 volts.

RATING AND CHARACTERISTIC CURVES (FM1200W THRU FM2000W)

FIG. 1 - TYPICAL FORWARD CURRENT DERATING CURVE

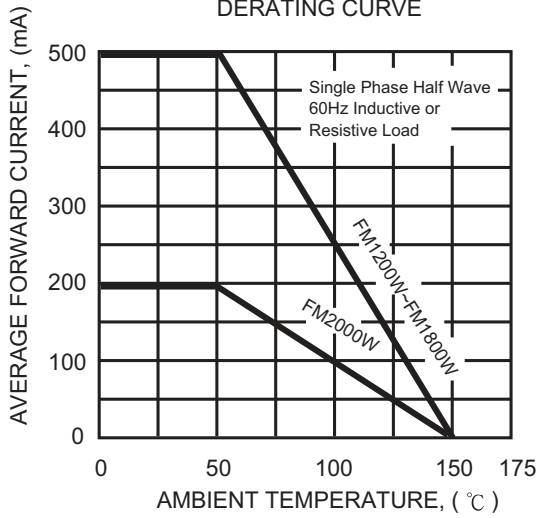

FIG. 2 - MAXIMUM NON-REPETITIVE FORWARD SURGE CURRENT

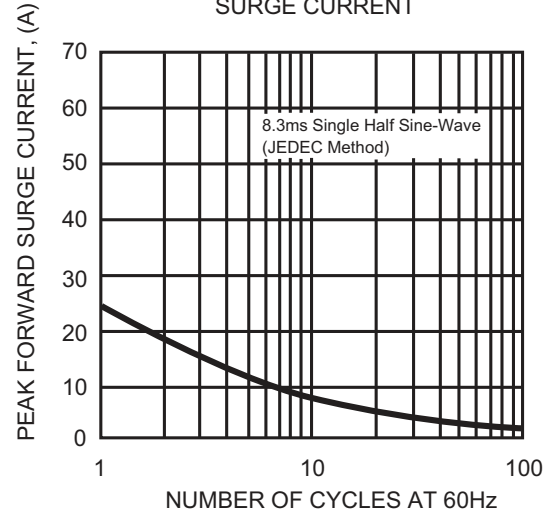
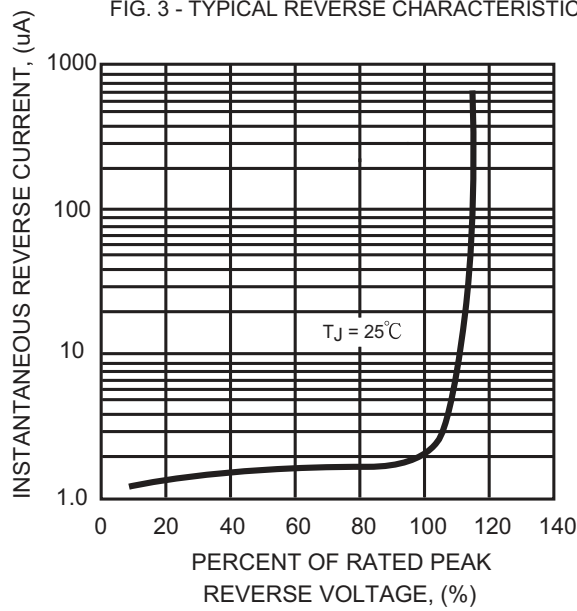
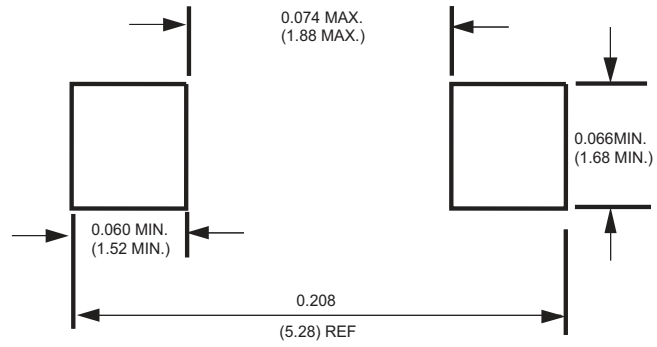

FIG. 3 - TYPICAL REVERSE CHARACTERISTICS



Mounting Pad Layout



Dimensions in inches and (millimeters)

Mark Description

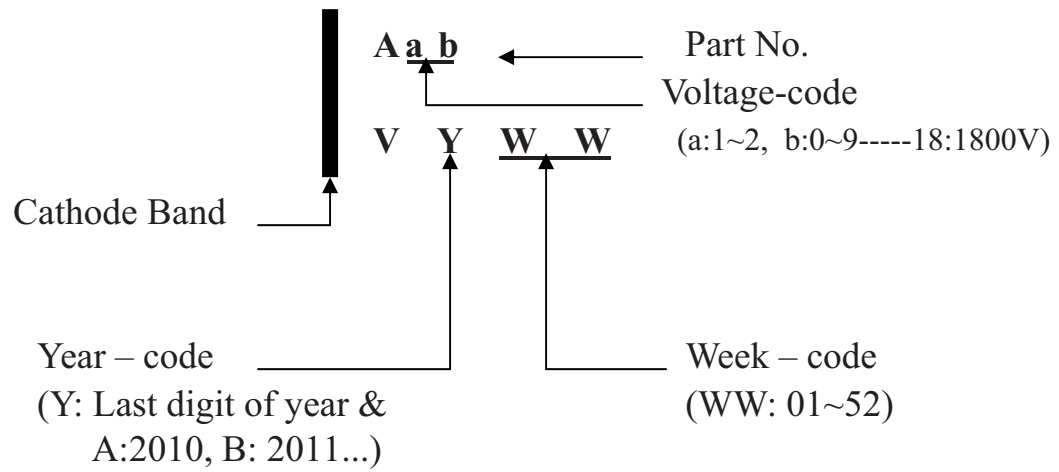

PACKAGING OF DIODE AND BRIDGE RECTIFIERS

REEL PACK

PACKAGE	PACKING CODE	EA PER REEL	COMPONENT SPACE(mm)	TAPE SPACE (mm)	REEL DIA (mm)	CARTON SIZE (mm)	EA PER CARTON	GROSS WEIGHT(Kg)
SMX	-T	1,500	---	---	180	390*205*310	48,000	---
SMX	-W	5,000	---	---	330	355*360*350	80,000	15.20

1. REEL

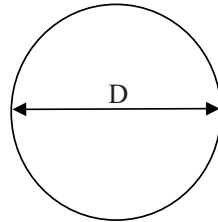

Packing Code	D (mm)
-T	180
-W	330

2. CARTON

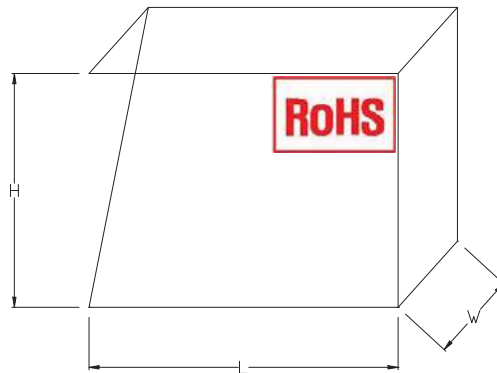

Packing Code	L (mm)	W (mm)	H (mm)
-T	390	205	310
-W	355	360	350

DISCLAIMER NOTICE

Rectron Inc reserves the right to make changes without notice to any product specification herein, to make corrections, modifications, enhancements or other changes. Rectron Inc or anyone on its behalf assumes no responsibility or liability for any errors or inaccuracies. Data sheet specifications and its information contained are intended to provide a product description only. "Typical" parameters which may be included on RECTRON data sheets and/ or specifications can and do vary in different applications and actual performance may vary over time. Rectron Inc does not assume any liability arising out of the application or use of any product or circuit.

Rectron products are not designed, intended or authorized for use in medical, life-saving implant or other applications intended for life-sustaining or other related applications where a failure or malfunction of component or circuitry may directly or indirectly cause injury or threaten a life without expressed written approval of Rectron Inc. Customers using or selling Rectron components for use in such applications do so at their own risk and shall agree to fully indemnify Rectron Inc and its subsidiaries harmless against all claims, damages and expenditures.