

External MIMO 2x5GNR + MIMO 2xWi-Fi + GNSS Combo Antenna



AECR1808A12

Request Samples



Check Inventory



189.0 x 182.0 x 85.0 mm
RoHS/RoHS II Compliant
MSL Level = 1

Features

- Wide band : 600 MHz ~ 6 GHz
- 5 in 1 Combo Antenna
 - 2xMIMO 5G NR/ 4G/ LTE
 - 2xMIMO Wi-Fi 2.4/5 GHz
 - 1x Active GNSS/GPS/GLONASS/BeiDou/QZSS
- Global 4G cellular band coverage including CAT M and NB-IoT
- IP67 rated
- Easy installation using Screw
- Fully customizable RF cable and connector options

Applications

- IoT
- M2M
- Smart City
- Telematics
- Transportation
- Smart Agriculture
- Geolocation and Tracking

Product Image



External MIMO 2x5GNR + MIMO 2xWi-Fi + GNSS Combo Antenna



AECR1808A12

Request Samples



Check Inventory



189.0 x 182.0 x 85.0 mm
RoHS/RoHS II Compliant
MSL Level = 1

Part Number Builder

AECR1808A12 -

Color / UV Coating	
Code	Description
S (Standard)	Black without UV coating
A	Black with UV Coating
B	White without UV Coating
C	White with UV Coating

Cable length in 'mm'	
Maximum cable length supported : RG-174 (up to 3000 mm) LMR-100 (up to 5000 mm)	
Code	Description
3000 (Standard)	3000 mm
Other Examples :	
0200	200 mm
2000	2000 mm

Cable Type & Connector Type				
Code	Cable Type	Connector Type		
		5G NR	GNSS	Wi-Fi
S (Standard)	RG-174	-	SMA (M)	-
	LMR-100	SMA (M)	-	SMA (M)
A	LMR-100	SMA (M)	SMA (M)	SMA (M)
B		SMA (M)	FAKRA C (F)	SMA (M)
C		FAKRA D (F)	SMA (M)	SMA (M)
D		FAKRA D (F)	FAKRA C (F)	SMA (M)
E	RG-174	-	FAKRA C (F)	-
	LMR-100	SMA (M)	-	SMA (M)
F	RG-174	-	SMA (M)	-
	LMR-100	FAKRA D (F)	-	SMA (M)
G	RG-174	-	FAKRA C (F)	-
	LMR-100	FAKRA D (F)	-	SMA (M)

Example Configurations :

Part Number	UV Protection Coating / Color	Cable length	Cable Type / Connector Type
AECR1808A12 S-3000S	No / Black	3000 mm	2xLMR-100 with 2xSMA (M) for 5G NR + 1xRG-174 with 1xSMA (M) for GNSS + 2xLMR-100 with 2xSMA (M) for Wi-Fi (Standard)
AECR1808A12 A-1000A	Yes / Black	1000 mm	2xLMR-100 with 2xFAKRA-D (F) for 5G NR + 1xLMR-100 with 1xFAKRA-C (F) for GNSS + 2xLMR-100 with 2xSMA (M) for Wi-Fi
AECR1808A12 B-5000G	No / White	5000 mm	2xLMR-100 with 2xFAKRA D (F) for 5G NR + 1xRG-174 with 1xFAKRA C (F) for GNSS + 2xLMR-100 with 2xSMA (M) for Wi-Fi

Note :

- For the standard part number (AECR1808A12**S-3000S**), please refer to the packaging at the end of the document.
- For additional configuration (AECR1808A12-), MOQs, pricing and packaging changes may be applicable.



5101 Hidden Creek Ln Spicewood TX 78669
 Phone: 512-371-6159 | Fax: 512-351-8858
 For terms and conditions of sales, please visit:
www.abracon.com

REVISED: 03-22-21

ABRACON IS
 ISO9001-2015
 CERTIFIED

External MIMO 2x5G NR + MIMO 2xWi-Fi + GNSS Combo Antenna



AECR1808A12

Request Samples



Check Inventory



189.0 x 182.0 x 85.0 mm
RoHS/RoHS II Compliant
 MSL Level = 1

Electrical Specifications

Parameter	Specification			Unit
	Min	Typ	Max	
MIMO 2x 5G NR (Main + Aux)				
Operating Frequency	600		6000	MHz
VSWR			4.0	
Peak Gain			4	dBi
Impedance		50		Ω
Polarization	Linear			
Power Rating			10	W
MIMO 2x Wi-Fi (Main + Aux)				
Operating Frequency	2400		2483.5	MHz
	4900		5925	
VSWR			2.5	
Peak Gain			4	dBi
Impedance		50		Ω
Polarization	Linear			
Power Rating			10	W
1x GNSS				
Operating Frequency	1561.098		1606	MHz
Peak Gain			3	dBi
VSWR			2.0	
Impedance		50		Ω
Polarization	RHCP			
LNA Gain	26	28	30	dBi
LNA NF			1.5	dB
Supply Voltage (DC)	3		5	V
Current Consumption			15	mA

Mechanical Specifications

Parameter	Specification
Antenna Dimension	189 x 182 x 85 mm
Material	PC + ABS
Mounting Type	Screw
RF Cable Type	1x RG-174 (GNSS) + 4x LMR100 (LTE, Wi-Fi)
RF Cable Length	3 m
RF Connector	5x SMA (M)
Mounting Torque	Recommended
	Maximum



5101 Hidden Creek Ln Spicewood TX 78669
 Phone: 512-371-6159 | Fax: 512-351-8858
 For terms and conditions of sales, please visit:
www.abracon.com

REVISED: 03-22-21

ABRACON IS
 ISO9001-2015
 CERTIFIED

External MIMO 2x5GNR + MIMO 2xWi-Fi + GNSS Combo Antenna



AECR1808A12

Request Samples



Check Inventory



189.0 x 182.0 x 85.0 mm
RoHS/RoHS II Compliant
MSL Level = 1

Environmental Specification

Parameter	Specification
Operating Temperature	-40°C to +85°C
Storage Temperature	-40°C to +85°C
IP Rating	IP67 (Excluding Cable Outlet)
UL Rating	UL-94 HB
RoHS Compliance	Yes
PB Free	Yes
MSL	1
ESD Sensitive	Yes
Relative Humidity	Up to 95%
Vibration	10 ~ 55 Hz with 1.5 mm amplitude 2 hrs

Product Dimension

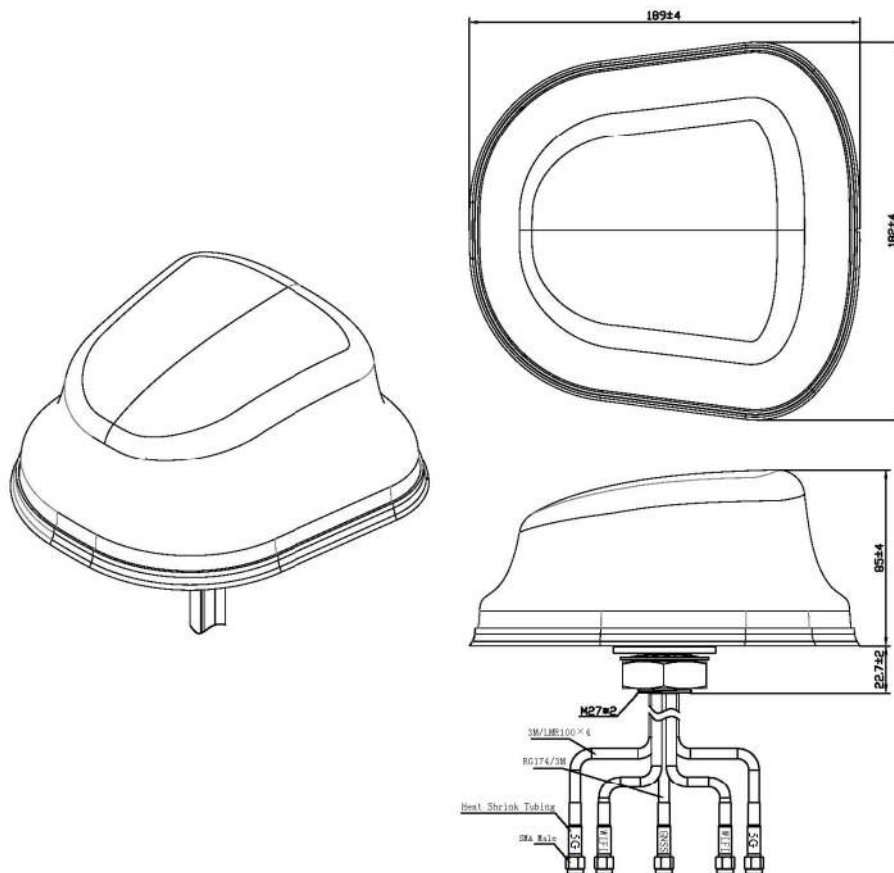

Unit : mm



5101 Hidden Creek Ln Spicewood TX 78669
 Phone: 512-371-6159 | Fax: 512-351-8858
 For terms and conditions of sales, please visit:
www.abracon.com

REVISED: 03-22-21

ABRACON IS
 ISO9001-2015
 CERTIFIED

External MIMO 2x5G NR + MIMO 2xWi-Fi + GNSS Combo Antenna



AECR1808A12

Request Samples



Check Inventory



189.0 x 182.0 x 85.0 mm
RoHS/RoHS II Compliant
MSL Level = 1

Test Measurement - VSWR

Cellular – 5G NR / 4G/ LTE

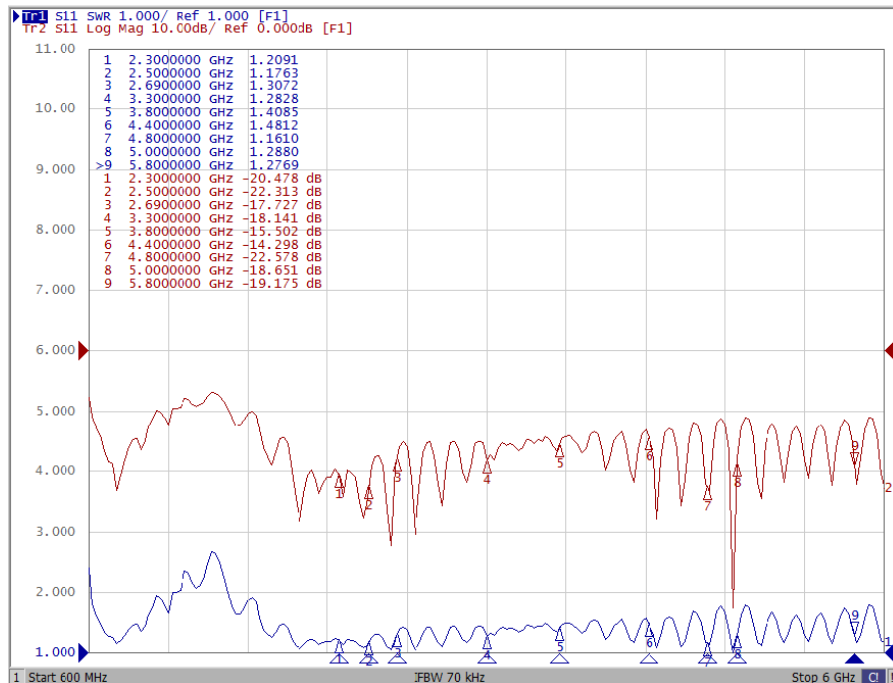
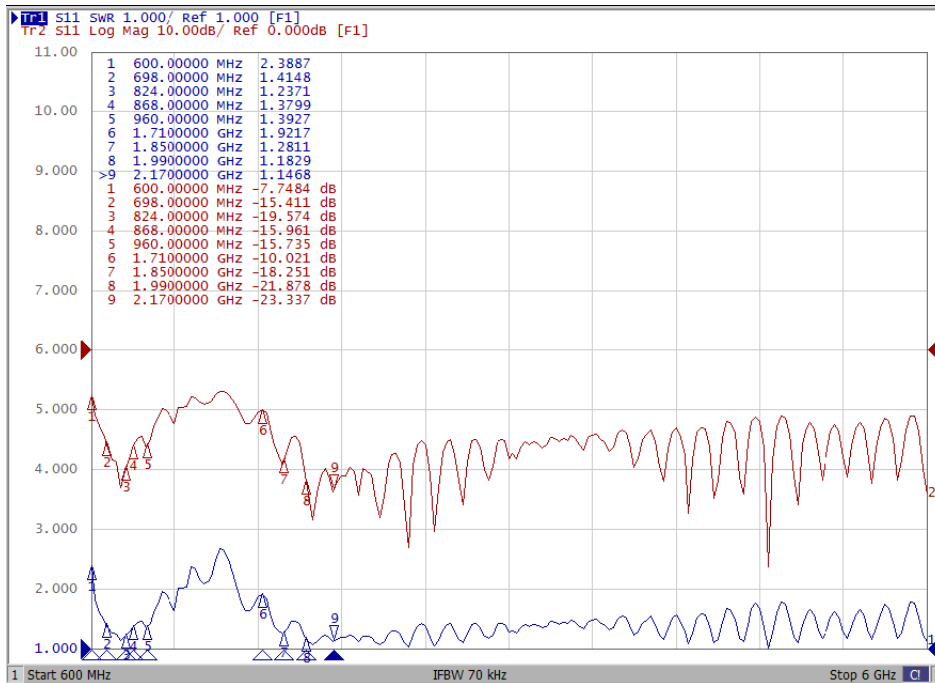

5101 Hidden Creek Ln Spicewood TX 78669
 Phone: 512-371-6159 | Fax: 512-351-8858
 For terms and conditions of sales, please visit:
www.abracon.com

REVISED: 03-22-21

ABRACON IS
 ISO9001-2015
 CERTIFIED

External MIMO 2x5GNR + MIMO 2xWi-Fi + GNSS Combo Antenna



AECR1808A12

Request Samples



Check Inventory



189.0 x 182.0 x 85.0 mm
RoHS/RoHS II Compliant
MSL Level = 1

Wi-Fi

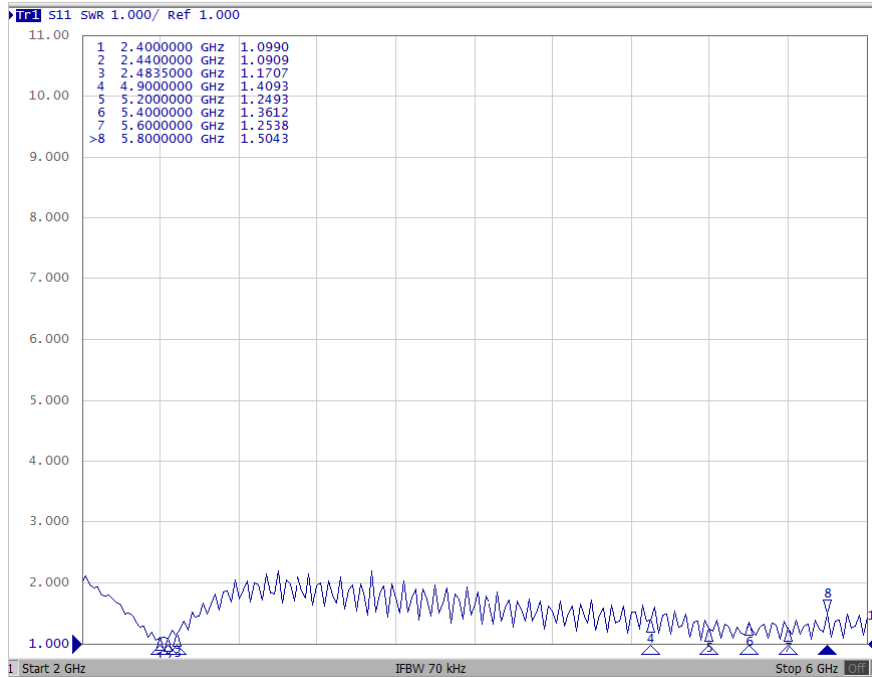

GNSS

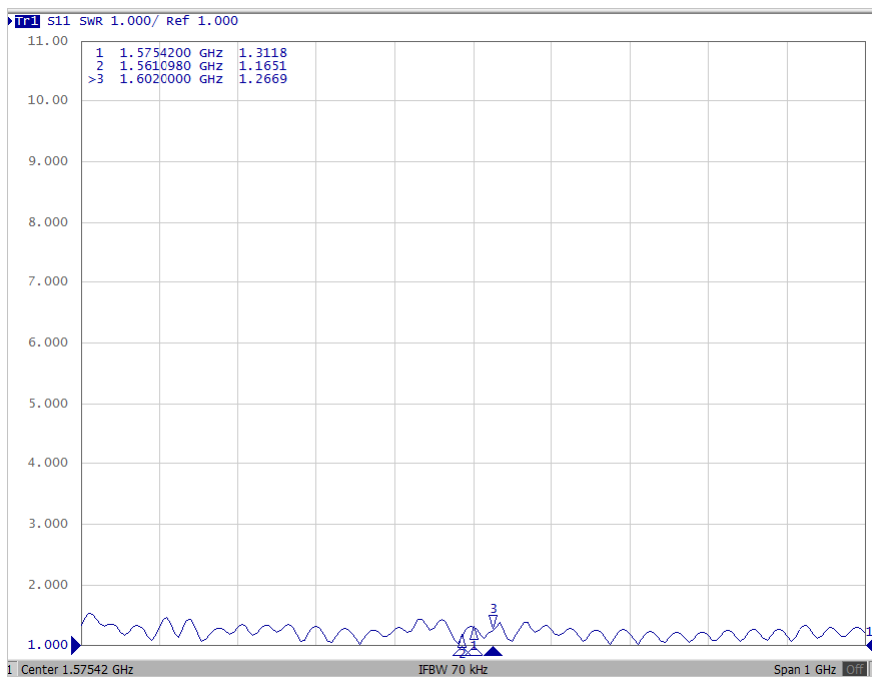

5101 Hidden Creek Ln Spicewood TX 78669
Phone: 512-371-6159 | Fax: 512-351-8858
For terms and conditions of sales, please visit:
www.abracon.com

REVISED: 03-22-21

ABRACON IS
ISO9001-2015
CERTIFIED

External MIMO 2x5GNR + MIMO 2xWi-Fi + GNSS Combo Antenna



AECR1808A12

Request Samples



Check Inventory



189.0 x 182.0 x 85.0 mm
RoHS/RoHS II Compliant
MSL Level = 1

Radiation Characteristics

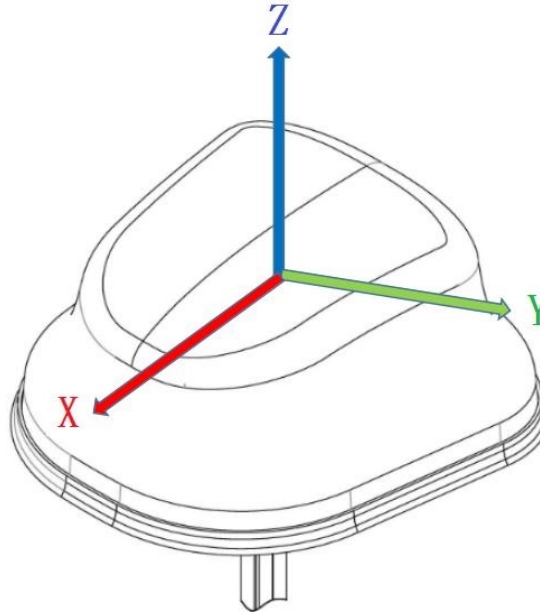

GNSS

2D Pattern

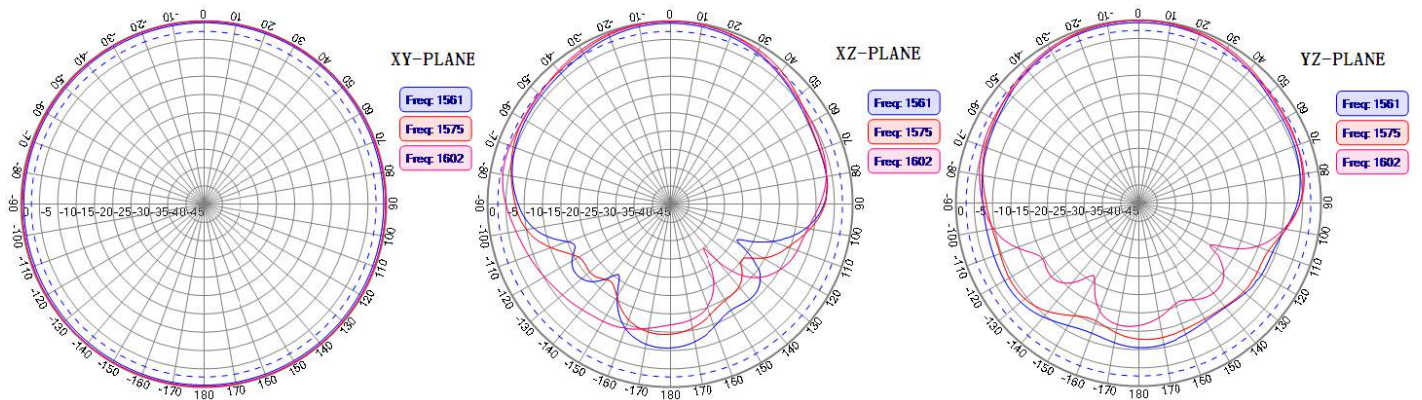

External MIMO 2x5GNR + MIMO 2xWi-Fi + GNSS Combo Antenna



AECR1808A12

Request Samples



Check Inventory



189.0 x 182.0 x 85.0 mm
RoHS/RoHS II Compliant
MSL Level = 1

MIMO 2x5G NR : Main & Aux

2D Pattern

XY - Plane

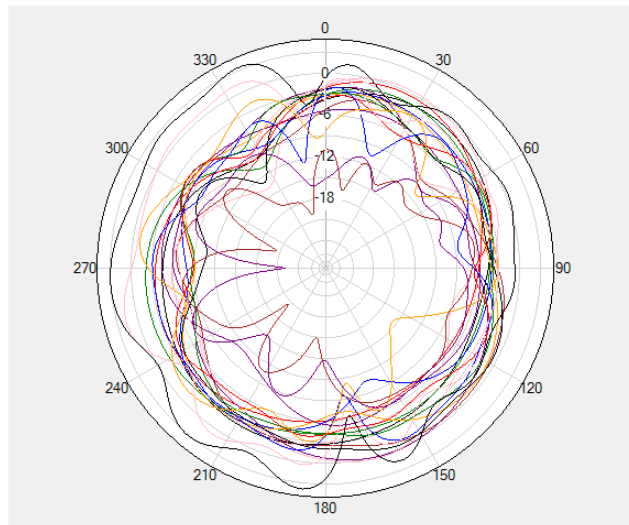

XZ - Plane

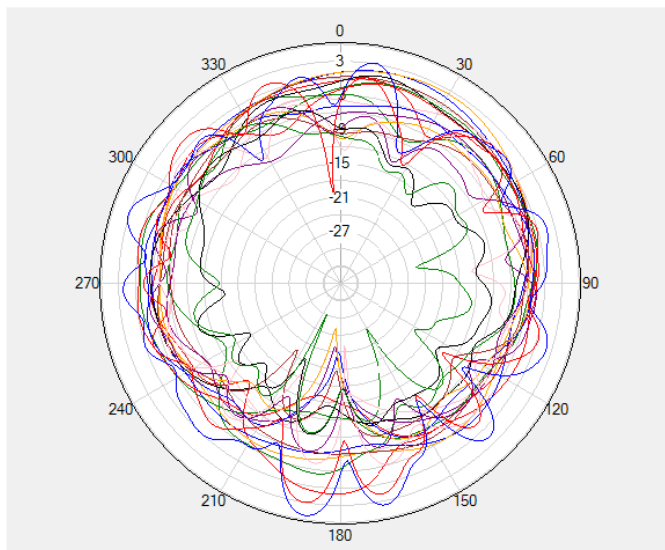

YZ - Plane

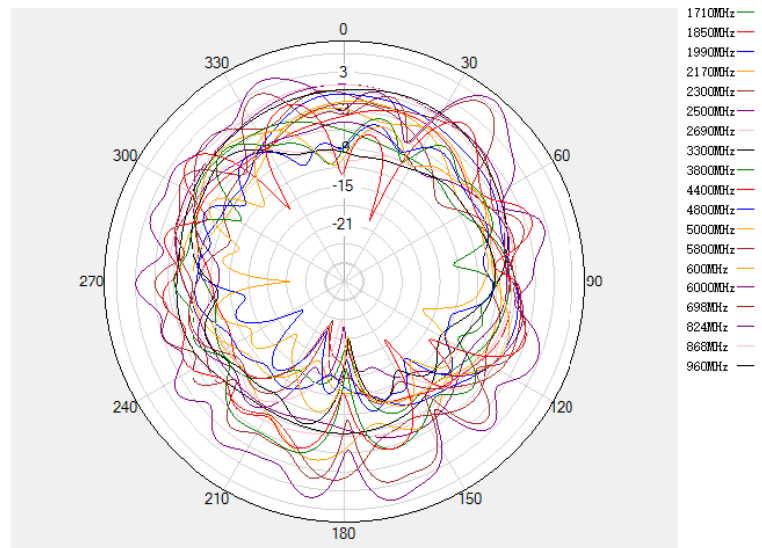

5101 Hidden Creek Ln Spicewood TX 78669
 Phone: 512-371-6159 | Fax: 512-351-8858
 For terms and conditions of sales, please visit:
www.abracon.com

REVISED: 03-22-21

ABRACON IS
 ISO9001-2015
 CERTIFIED

External MIMO 2x5GNR + MIMO 2xWi-Fi + GNSS Combo Antenna



AECR1808A12

Request Samples



Check Inventory



189.0 x 182.0 x 85.0 mm
RoHS/RoHS II Compliant
MSL Level = 1

3D Pattern

600 MHz

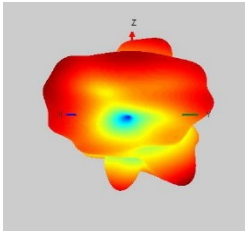

698 MHz

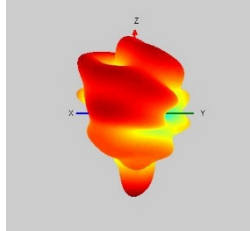

824 MHz

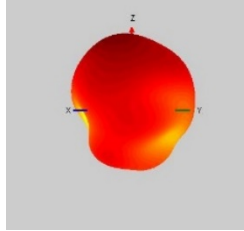

868 MHz

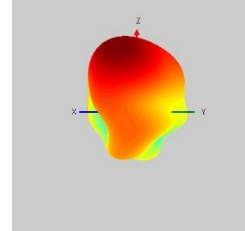

960 MHz

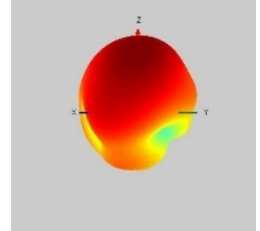

1710 MHz

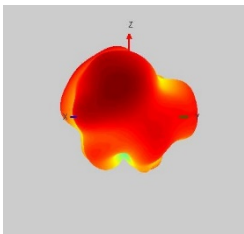

1850 MHz

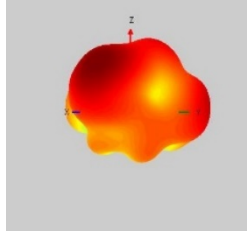

1990 MHz

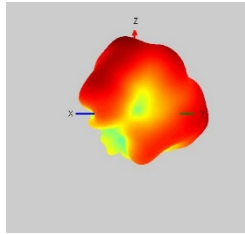

2170 MHz

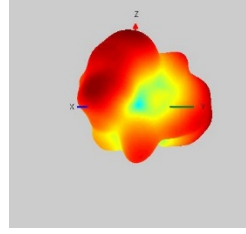

2300 MHz

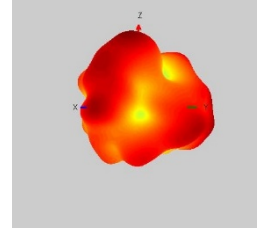

2500 MHz

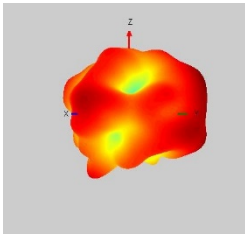

2690 MHz

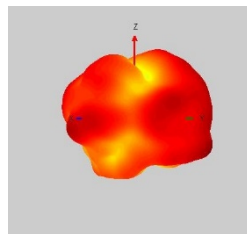

3300 MHz

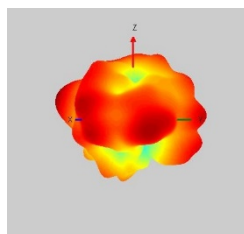

3800 MHz

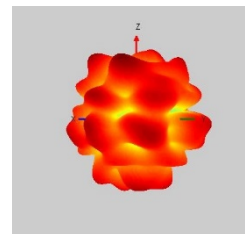

4400 MHz

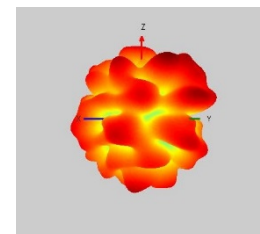

4800 MHz

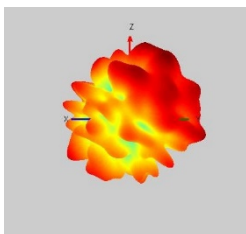

5000 MHz

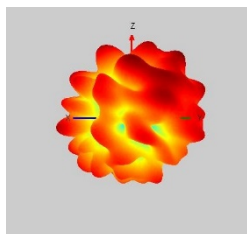

5800 MHz

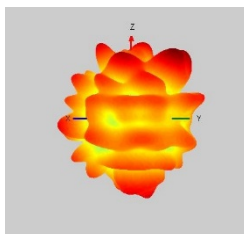

6000 MHz

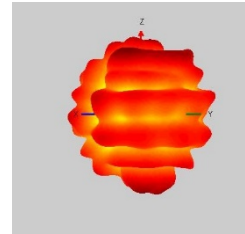

External MIMO 2x5GNR + MIMO 2xWi-Fi + GNSS Combo Antenna



AECR1808A12

Request Samples



Check Inventory



189.0 x 182.0 x 85.0 mm
RoHS/RoHS II Compliant
MSL Level = 1

MIMO 2xWi-Fi : Main & Aux

2D Pattern

XY - Plane

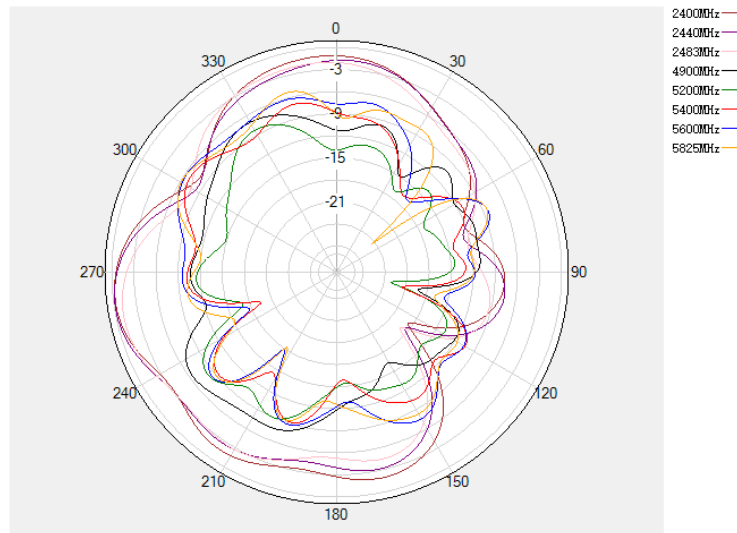

XZ - Plane

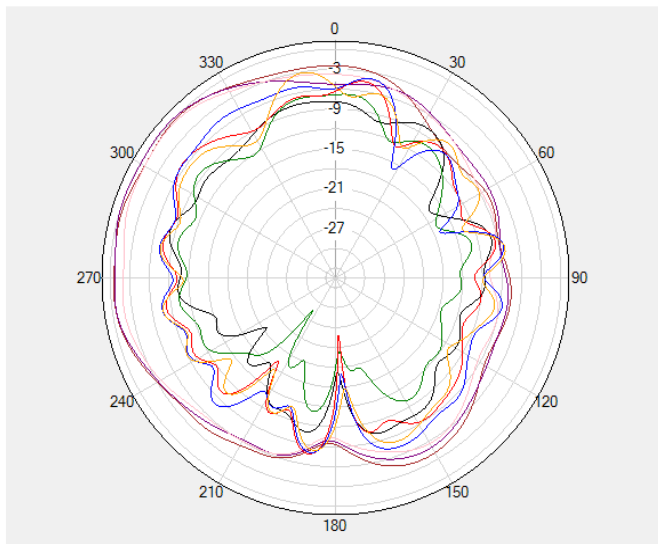

YZ - Plane

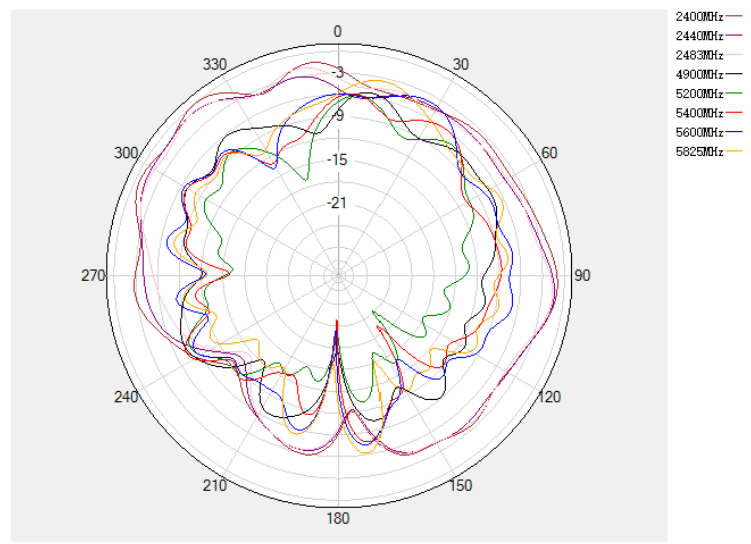

5101 Hidden Creek Ln Spicewood TX 78669
Phone: 512-371-6159 | Fax: 512-351-8858
For terms and conditions of sales, please visit:
www.abracon.com

REVISED: 03-22-21

ABRACON IS
ISO9001-2015
CERTIFIED

External MIMO 2x5GNR + MIMO 2xWi-Fi + GNSS Combo Antenna



AECR1808A12

Request Samples



Check Inventory



189.0 x 182.0 x 85.0 mm
RoHS/RoHS II Compliant
MSL Level = 1

3D Pattern

2400 MHz

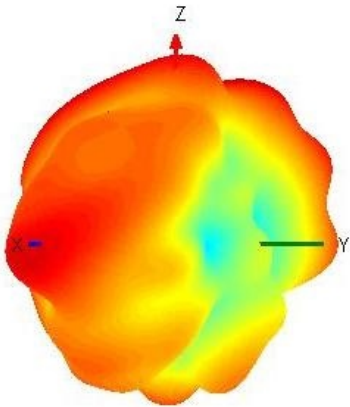

2440 MHz

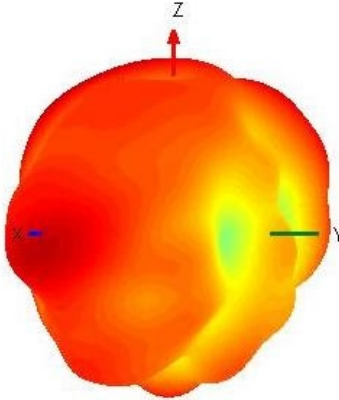

2483 MHz

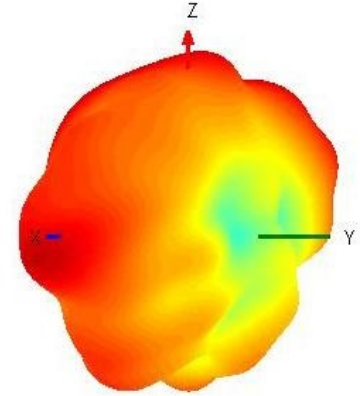

4900 MHz

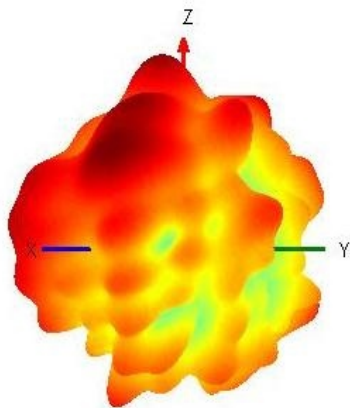

5200 MHz

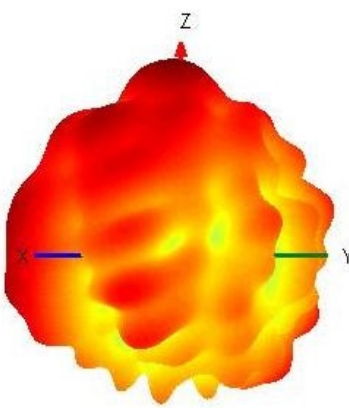

5400 MHz

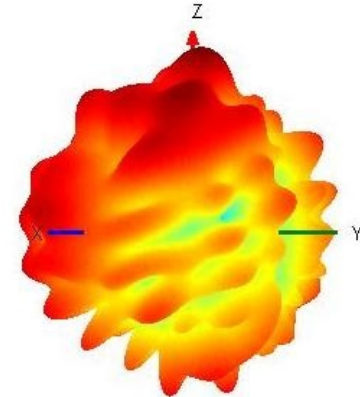

5600 MHz

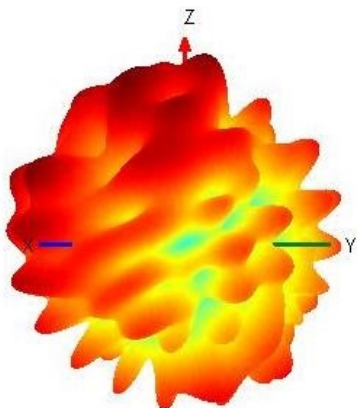

5825 MHz

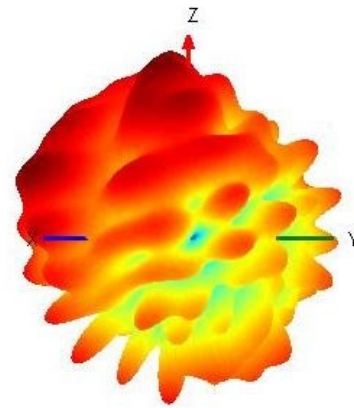

5101 Hidden Creek Ln Spicewood TX 78669
Phone: 512-371-6159 | Fax: 512-351-8858
For terms and conditions of sales, please visit:
www.abracon.com

REVISED: 03-22-21

ABRACON IS
ISO9001-2015
CERTIFIED

External MIMO 2x5G NR + MIMO 2xWi-Fi + GNSS Combo Antenna



AECR1808A12

Request Samples



Check Inventory



189.0 x 182.0 x 85.0 mm
RoHS/RoHS II Compliant
 MSL Level = 1

Efficiency & Gain

Frequency (MHz)	Efficiency	Gain (dBi)
MIMO 2x5G NR (Main + Aux)		
600	0.63	1.58
698	0.66	1.92
824	0.69	3.26
868	0.55	1.34
960	0.54	1.74
1710	0.57	0.75
1850	0.54	0.72
1990	0.57	0.65
2170	0.59	2.98
2300	0.57	2.75
2500	0.57	2.57
2690	0.61	1.38
3300	0.52	-0.49
3800	0.51	-1.49
4400	0.65	2.16
4800	0.56	-0.17
5000	0.59	-0.57
5800	0.57	4.27
6000	0.55	3.97
MIMO 2xWi-Fi (Main + Aux)		
2400	0.57	4.05
2440	0.54	1.65
2483	0.55	1.47
4900	0.54	-0.75
5200	0.49	-0.59
5400	0.49	1.05
5600	0.51	2.10
5825	0.52	3.17



5101 Hidden Creek Ln Spicewood TX 78669
 Phone: 512-371-6159 | Fax: 512-351-8858
 For terms and conditions of sales, please visit:
www.abracon.com

REVISED: 03-22-21

ABRACON IS
 ISO9001-2015
 CERTIFIED

External MIMO 2x5GNR + MIMO 2xWi-Fi + GNSS Combo Antenna



AECR1808A12

Request Samples



Check Inventory



189.0 x 182.0 x 85.0 mm
RoHS/RoHS II Compliant
MSL Level = 1

Packaging Information

Number of Antenna/ Carton : 8 pcs
Dimension of the Carton : 430 x 430 x 340 mm
Weight of 1 pc of antenna : 1 kg
Weight of the Carton : 9.5 kg

ATTENTION: Abracon LLC's products are COTS – Commercial-Off-The-Shelf products; suitable for Commercial, Industrial and, where designated, Automotive Applications. Abracon's products are not specifically designed for Military, Aviation, Aerospace, Life-dependent Medical applications or any application requiring high reliability where component failure could result in loss of life and/or property. For applications requiring high reliability and/or presenting an extreme operating environment, written consent and authorization from Abracon LLC is required. Please contact Abracon LLC for more information.



5101 Hidden Creek Ln Spicewood TX 78669
Phone: 512-371-6159 | Fax: 512-351-8858
For terms and conditions of sales, please visit:
www.abracon.com

REVISED: 03-22-21

ABRACON IS
ISO9001-2015
CERTIFIED