



# GU SERIES SINGLE LED MODULE



RECOGNIZED COMPONENT



## FEATURES / BENEFITS

- ▲ Long life, up to 60,000 hours
- ▲ Low 1.2 watt power consumption @ 350mA
- ▲ Dimmable
- ▲ Low profile - ADA compliant
- ▲ Optional niche mounting box available for direct burial in concrete or ground
- ▲ Uses the latest LUXEON® Rebel LED technology
- ▲ ETL recognized to UL2108 standards for dry, damp or wet locations
- ▲ IP67 rated for interior or exterior use

## APPLICATIONS

Ideal for any difficult to maintain location low level pathway systems, architectural accent, staircases, decks, kitchens, etc. Easily mounts to wood, tile, stone, glass, stainless steel, etc

## MATERIALS/FINISH

- ▲ Anodized aluminum base and “snap-on” top cover
- ▲ PMMA lens
- ▲ PTFE lead wires 20” (508mm) long, 20 AWG

## OPERATING CONDITIONS

- ▲ Requires 350mA max constant current driver
- ▲ Ambient Temperature limits -30°C to +55°C (-22°F to +131°F)
- ▲ MDU9-35-70 runs 1-9 units
- ▲ 350mA max input current

## ORDERING INFORMATION

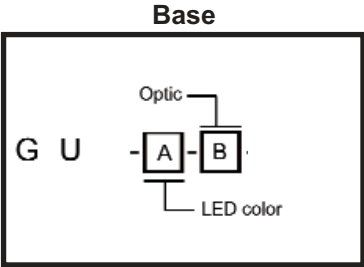

LED Color (A)
W = White 5300K / *100 lumen min
NW = Neutral White 4000K / *100 lumen min
WW = Warm White 3050K / *50 lumen min
B = Blue

**Covers**

Series - Cover Type
GU - Dome
GU - Flush
GU - Eyelid

**GU-MBX - Mounting Box**

**Base & cover purchased separately**

\* LED flux data is manufacturers test data @ 25°C T<sub>j</sub>. Light output at max acceptable ambient temp will be approximately 25-30% lower, depending on thermal conductivity of mounting surface and lens type.

# MOUNTING INFORMATION

Mounting box for physical setting & stability. It is not waterproof, make connections with waterproof wire nuts.

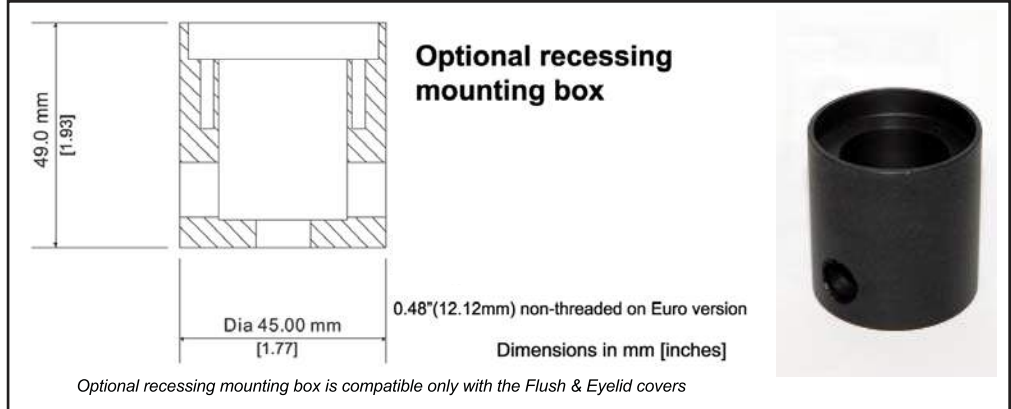
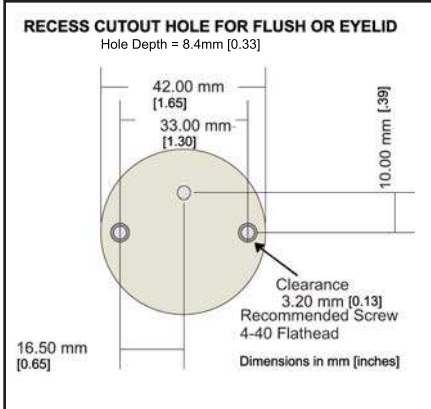

# PHOTOMETRIC DATA

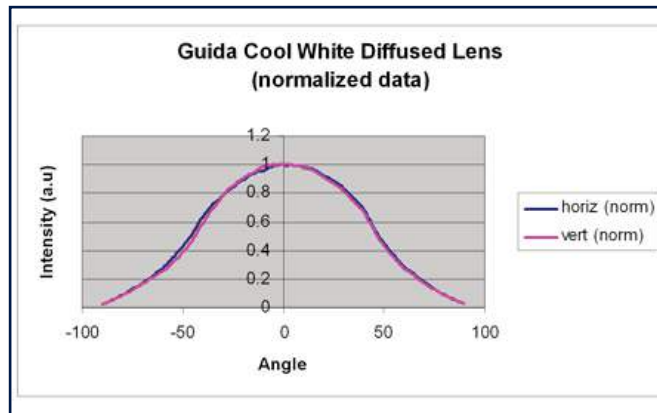

# MECHANICAL DIMENSIONS

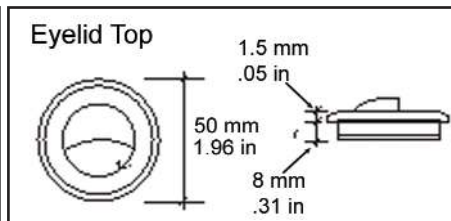
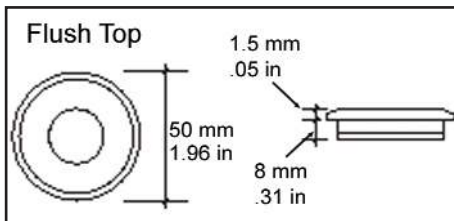
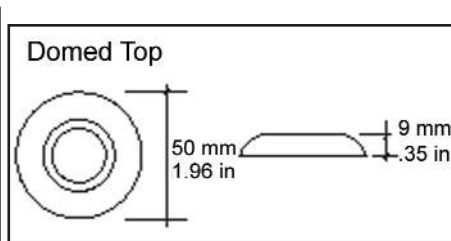
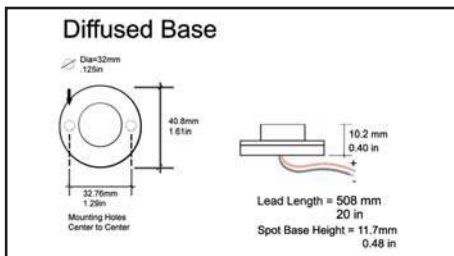

# WIRING DIAGRAM

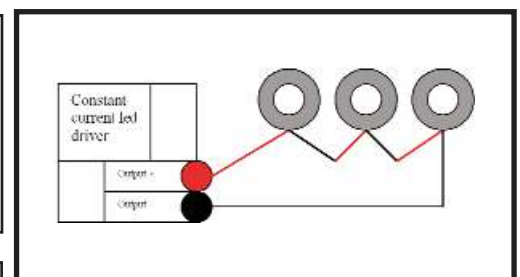

Dialight reserves the right to make changes at any time in order to supply the best product possible.

Eyelid top not compatible with spot base optic

Dialight reserves the right to make changes at any time in order to supply the best product possible.

The most current version of this document will always be available at:  
[www.dialight.com/Assets/Brochures\\_And\\_Catalogs/Illumination/MDEXLUMGU1.pdf](http://www.dialight.com/Assets/Brochures_And_Catalogs/Illumination/MDEXLUMGU1.pdf)

MDEXLUMGU1\_C