

Features

Switching Regulator

- 20A non isolated quarter brick
- 18 to 75VDC wide input range
- 3.3 to 24VDC adjustable output
- Standard industrial quarter brick format
- High efficiency up to 98%
- Operating temperature derates to 120°C

RPMGQ-20

**20 Amp
QTR Brick
Open Frame
Single Output**



Selection Guide

Part Number	Input Voltage Range ⁽¹⁾ [VDC]	Output Voltage [VDC]	Vout Adjust Range [VDC]	Output Current max. [A]	Efficiency typ. [%]	Max. Capacitive Load [μ F]
RPMGQ5.0-20	18-75	5	3.3 - 8	20	91 - 94	15000
RPMGQ12-20	18-75	12	8 - 24	20	95 - 97	12000

Notes:

Note1: Measured Values are with $C_{IN}= 880\mu$ F + $C_{OUT}= 4000\mu$ F

Model Numbering

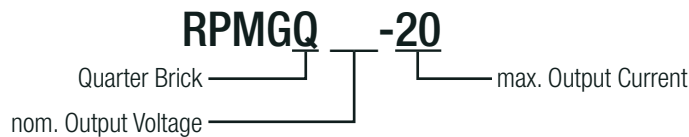

Specifications (measured @ Ta= 25°C, nom. Vin, full load and after warm-up unless otherwise stated)

BASIC CHARACTERISTICS				
Parameter	Condition	Min.	Typ.	Max.
Internal Input Filter				capacitor
Input Voltage Range		18VDC		75VDC
Absolute Maximum Input Voltage				80VDC
Undervoltage Lockout (UVLO)	DC-DC ON DC-DC OFF		16.5VDC 14.0VDC	
Input Current	RPMGQ5.0-20 RPMGQ12-20		2.3A 5.2A	
Quiescent Current (no load)			30mA	
No Load Power Consumption	V _{IN} = 24VDC V _{IN} = 48VDC V _{IN} = 60VDC		720mW 1440mW 1800mW	
Internal Power Dissipation				10W

continued on next page

Specifications (measured @ $t_a = 25^\circ\text{C}$, nom. V_{in} , full load and after warm-up unless otherwise stated)

Parameter	Condition		Min.	Typ.	Max.
Output Voltage Trimming ⁽²⁾	RPMGQ5.0-20		3.3VDC		8VDC
	RPMGQ12-20		8VDC		24VDC
Minimum Load			0%		
Startup-time	RPMGQ5.0-20			13ms	
	RPMGQ12-20			20ms	
Rise-time	RPMGQ5.0-20			8ms	
	RPMGQ12-20			16ms	
ON/OFF CTRL	DC-DC ON		Open or $1.8\text{V} < V_{CTRL} < 5.4\text{VDC}$		
	DC-DC OFF		Short or $0\text{V} < V_{CTRL} < 0.9\text{VDC}$		
Standby Current	DC-DC OFF CTRL to GND	RPMGQ5.0-20	$V_{IN} = 24\text{VDC}$	0.065mA	
			$V_{IN} = 48\text{VDC}$	0.126mA	
			$V_{IN} = 60\text{VDC}$	0.156mA	
		RPMGQ12-20	$V_{IN} = 24\text{VDC}$	0.065mA	
			$V_{IN} = 48\text{VDC}$	0.133mA	
			$V_{IN} = 60\text{VDC}$	0.162mA	
Internal Operating Frequency			200kHz	210kHz	220kHz

Notes:

Note2: For more detailed information, please refer to "OUTPUT VOLTAGE TRIMMING"

Typical Application

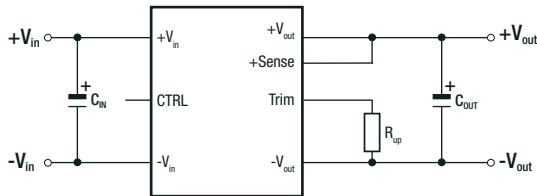

VOUTset	CIN	Rup	COUT
15VDC	>200µF	10kΩ	>=1000µF

For nom. V_{OUT} leave Trim pin open

Efficiency vs. Load

RPMGQ5.0-20

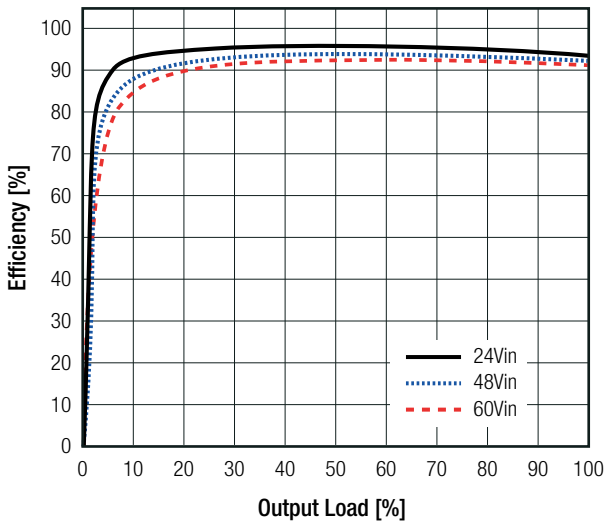

RPMGQ12-20

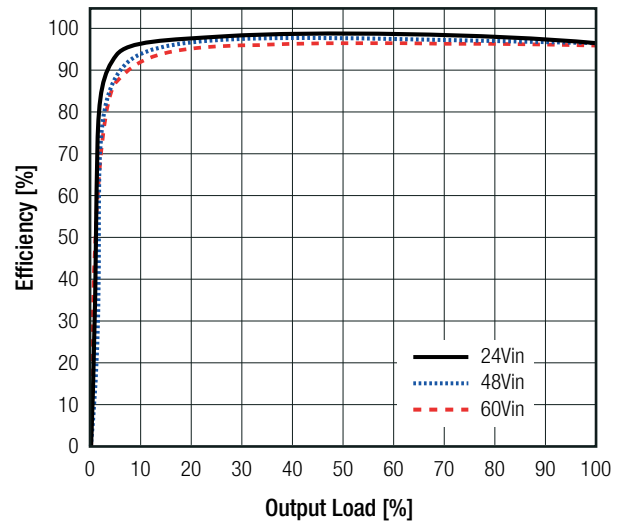

Specifications (measured @ $t_a = 25^\circ\text{C}$, nom. V_{in} , full load and after warm-up unless otherwise stated)

OUTPUT VOLTAGE TRIMMING

The RPMGQ series offers the feature of trimming the output voltage over a range between 3.3V and 8V by using external trim resistors. The values for trim resistors shown in trim tables below are according to standard E96 values; therefore, the specified voltage may slightly vary.

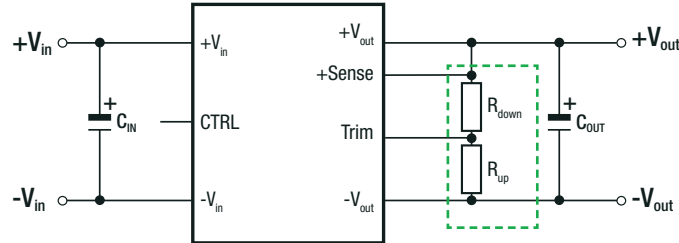

$V_{out_{nom}}$ = nominal output voltage [VDC]
 $V_{out_{set}}$ = trimmed output voltage [VDC]
 R_{up} = trim up resistor [Ω]
 R_{down} = trim down resistor [Ω]
 R_3, R_4, R_5 = internal resistors [Ω]

	R_3 [Ω]	R_4 [Ω]	R_5 [Ω]	V_{REF} [VDC]
RPMGQ5.0-20	18k72	3k48	3k48	0.8
RPMGQ12-20	48k7	3k48	2k87	0.8

Calculation:

$$R_{UP} = \frac{V_{REF} \times R_3 \times (R_4 + R_5) - R_4 \times R_5 \times (V_{OUTset} - V_{REF})}{(V_{OUTset} - V_{REF}) \times R_4 - V_{REF} \times R_3} = k\Omega$$

$$R_{DOWN} = \frac{V_{OUTset} \times (R_3 \times R_4 + R_4 \times R_5) - V_{REF} \times (R_3 \times R_4 + R_4 \times R_5 + R_3 \times R_5)}{V_{REF} \times (R_3 \times R_4) - R_4 \times V_{OUTset}} = k\Omega$$

RPMGQ5.0-20

Trim up

$V_{out_{set}} =$	5.5	6.0	7.0	8.0	[VDC]
R_{up} (E96) \approx	33k2	13k3	4k42	1k69	[Ω]

Trim down

$V_{out_{set}} =$	3.3	3.6	4.0	4.5	[VDC]
R_{down} (E96) \approx	22k6	31k6	51k	113k	[Ω]

RPMGQ12.0-20

Trim up

$V_{out_{set}} =$	15.0	18.0	20.0	24.0	[VDC]
R_{up} (E96) \approx	10k	3k57	2k	0k374	[Ω]

Trim down

$V_{out_{set}} =$	8.0	9.0	10.0	11.0	[VDC]
R_{down} (E96) \approx	84k5	130k	221k	499k	[Ω]

REMOTE SENSE

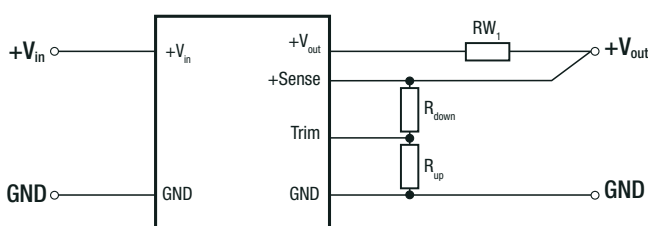

The output voltage can be adjusted via the trim and sense functions.

The maximum output voltage from Trim and Sense function combined is 8VDC for RPMGQ5.0-20 and 24VDC for RPMGQ12-20. Derating may be required when using Trim and/or sense functions.

RW_1 ... wire losses +
 R_{up} ... trim up resistor
 R_{down} ... trim down resistor

Specifications (measured @ $t_a = 25^\circ\text{C}$, nom. V_{in} , full load and after warm-up unless otherwise stated)

REGULATIONS				
Parameter	Condition			Value
Output Accuracy				$\pm 1.0\%$ max.
Line Regulation	low line to high line, full load			0.5% typ. / $\pm 1.0\%$ max.
Load Regulation	0% to 100% load			0.5% typ. / $\pm 1.0\%$ max.
Transient Response	5% - 100%	RPMGQ5.0-20	$V_{IN} = 24\text{VDC}$	40mV typ.
			$V_{IN} = 48\text{VDC}$	70mV typ.
			$V_{IN} = 60\text{VDC}$	90mV typ.
	5% - 100%	RPMGQ12-20	$V_{IN} = 24\text{VDC}$	50mV typ.
			$V_{IN} = 48\text{VDC}$	95mV typ.
			$V_{IN} = 60\text{VDC}$	110mV typ.

PROTECTIONS			
Parameter	Condition		Value
Short Circuit Protection (SCP)	hiccup mode, auto recovery	RPMGQ5.0-20	22.1A
		RPMGQ12-20	20.6A
Short Circuit Input Current	$V_{IN} = 24\text{VDC}$		30mA typ.
	$V_{IN} = 48\text{VDC}$		18mA typ.
Over Current Protection (OCP)	hiccup mode, auto recovery	RPMGQ5.0-20	22.1A
		RPMGQ12-20	20.6A
Over Temperature Protection (OTP)	measured on IC		160°C , auto restart after cool down

SAFETY AND CERTIFICATIONS		
Certificate Type (Safety)	Report / File Number	Standard
RoHS 2+		RoHS 2011/65/EU + AM2015/863
EMC Compliance	Condition	Standard / Criterion
Electromagnetic compatibility of multimedia equipment - emission requirements	with external components (see filter suggestions below)	EN55032, Class A and B

EMC filtering suggestion according to EN55032

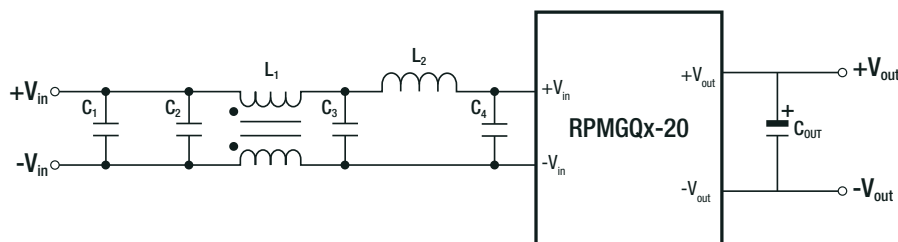

Component List Class A

C1	C2	C3	C4	L1	L2	C _{OUT}
2x 330 μF	3x 22 μF	10 μF	1000 μF	56 μH	10 μH	$\geq 1000\mu\text{F}$

Specifications (measured @ $t_a = 25^\circ\text{C}$, nom. V_{in} , full load and after warm-up unless otherwise stated)

ENVIRONMENTAL

Parameter	Condition		Value
Operating Temperature Range	with forced airflow		-40°C to $+120^\circ\text{C}$
Operating Humidity	non-condensing		5% - 95% RH max.
Operating Altitude			5000m
Vibration	MIL-STD-833G, method 2026 test condition II, letter "B"		
MTBF	according to MIL-HDBK-217F, G.B.	RPMGQ5.0-20	1208×10^3 hours
		RPMGQ12-20	1239×10^3 hours

Derating Graph

24Vin

RPMGQ5.0-20

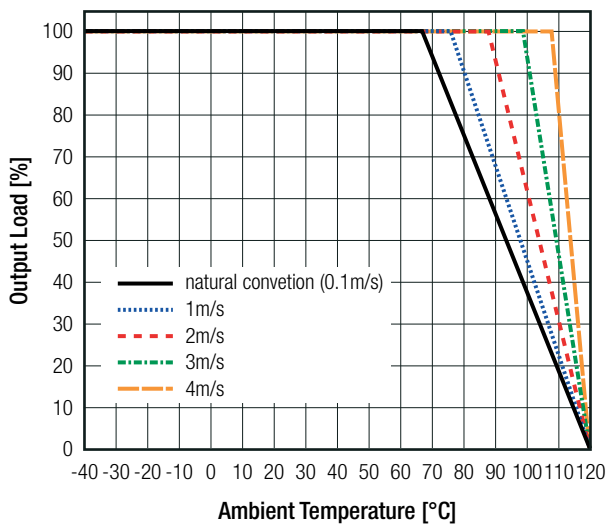

RPMGQ12-20

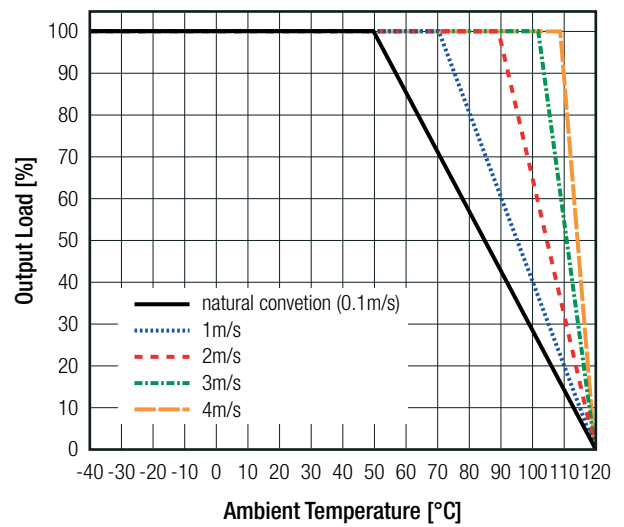

48Vin

RPMGQ5.0-20

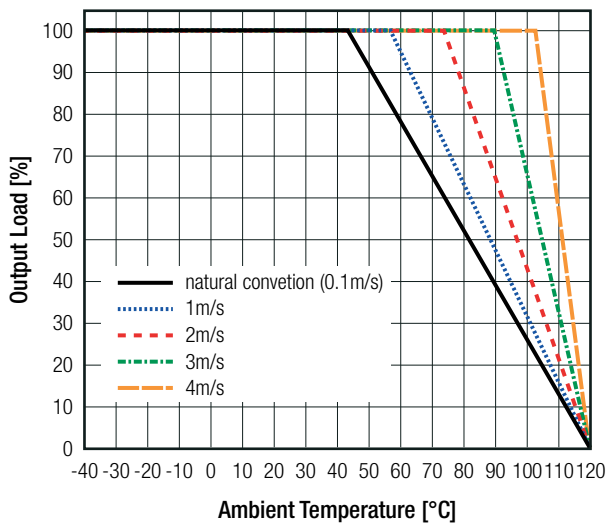

RPMGQ12-20

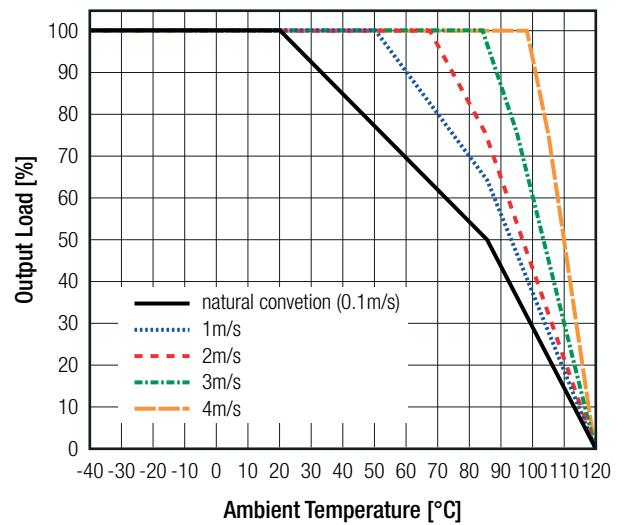

Specifications (measured @ $t_a = 25^\circ\text{C}$, nom. V_{in} , full load and after warm-up unless otherwise stated)

DIMENSION AND PHYSICAL CHARACTERISTICS

Parameter	Type	Value
Material	PCB	FR4, (UL94 V-0)
Dimension (LxWxH)		56.4 x 36.83 x 15.0mm
Weight		29g typ.

Dimension Drawing (mm)

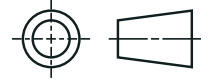
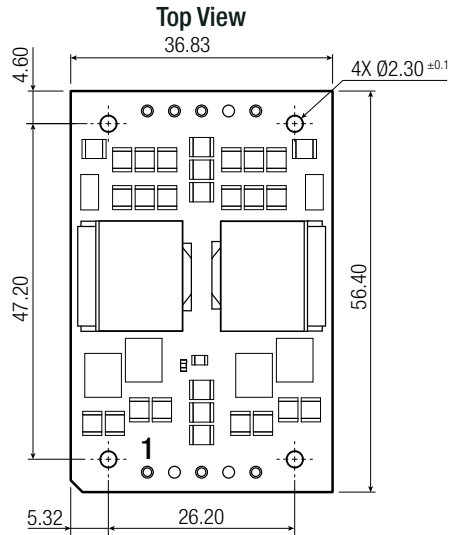

Pinning Information

Pin #	Single	Pin \varnothing
1	+Vin	1.02
2	CTRL/UVLO	1.02
3	-Vin	1.02
4	-Vout	1.57
5	TRIM	1.02
6	+SENSE	1.02
7	+Vout	1.57

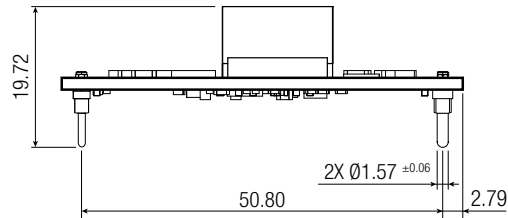
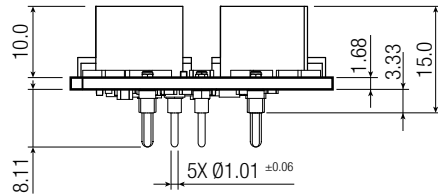

Bottom View RPMGQ5.0-20

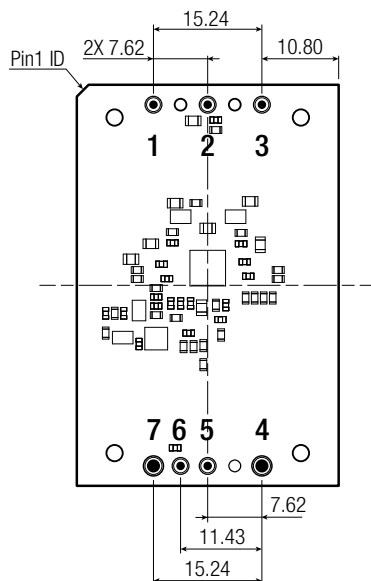

Bottom View RPMGQ12-20

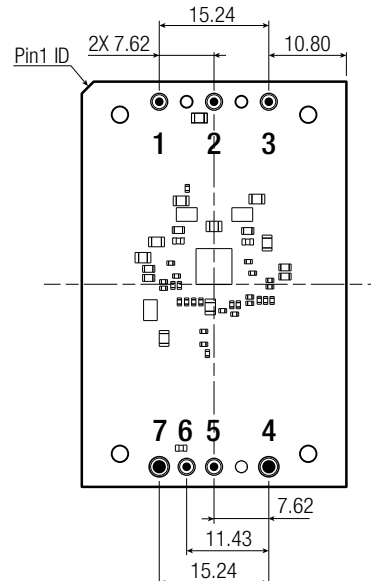

Tolerance:
xx.x= $\pm 0.5\text{mm}$
xx.xx= $\pm 0.25\text{mm}$

continued on next page

Specifications (measured @ $t_a = 25^\circ\text{C}$, nom. Vin, full load and after warm-up unless otherwise stated)

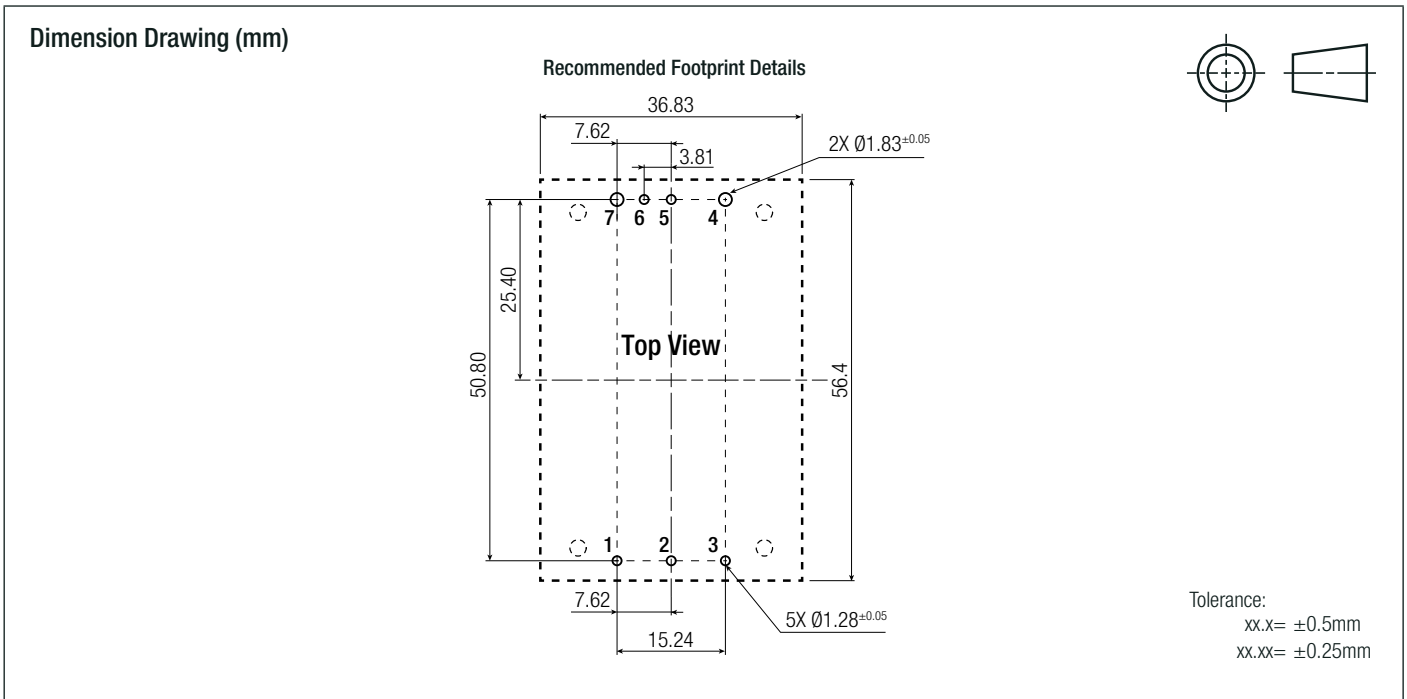

PACKAGING INFORMATION

Parameter	Type	Value
Packaging Dimension (LxWxH)	tray	305.0 x 165.0 x 45.0mm
Packaging Quantity		10pcs
Storage Temperature Range		-55°C to +125°C
Storage Humidity	non-condensing	95% RH max.

The product information and specifications may be subject to changes even without prior written notice. The product has been designed for various applications; its suitability lies in the responsibility of each customer. The products are not authorized for use in safety-critical applications without RECOM's explicit written consent. A safety-critical application is an application where a failure may reasonably be expected to endanger or cause loss of life, inflict bodily harm or damage property. The applicant shall indemnify and hold harmless RECOM, its affiliated companies and its representatives against any damage claims in connection with the unauthorized use of RECOM products in such safety-critical applications.