

The PM Series has been specifically designed for telecom, datacom and computer applications, offering a wide range of inputs/outputs and a power rating of up to 30 Watts.

INPUT

Input voltage range	9 to 18VDC for 12V model 18 to 36VDC for 24V model 36 to 75VDC for 48V model
---------------------	--

OUTPUT

Power (convection cooled)	10 to 30 W
Output adjustable	+/- 10% (PM20 and PM30)
Line regulation	0,2% for single and dual models 3% auxiliary output on triple output models
Load regulation	1 at 3% (of 10% at 100% full charge) 8% auxiliary output on triple output models
Ripple and noise (value peak to peak)	75mV on outputs 3V and 5V 100mV on single outputs or dual 12V and 15V 100 at 150mV auxiliary output triple output models
Temperature coefficient	0.015%/°C
Current limit	Automatic electronic current limiting
Over voltage	Prefixed threshold

GENERAL

Remote control	(PM20 and PM30)
Efficiency	66% to 78%
Voltage isolation : Input-Output	900 VAC 1500VDC on 48V model
Connection in series	possible

ENVIRONMENTAL

Operating temperature utilise full charge	-25°C ~ 70°C	10W
	-25°C ~ 60°C	20W
	-25°C ~ 50°C	30W
recovery at -40°C possible		
Derating (type)	linear until a case temperature reaches 105°C (P=0W)	
Storage temperature	-40°C to +105°C	
Relative humidity in utilisation in storage	5% ~ 95%	
Vibration	10 ~ 50HZ random vibration (2.5 G RMS) 10 mins each axis	

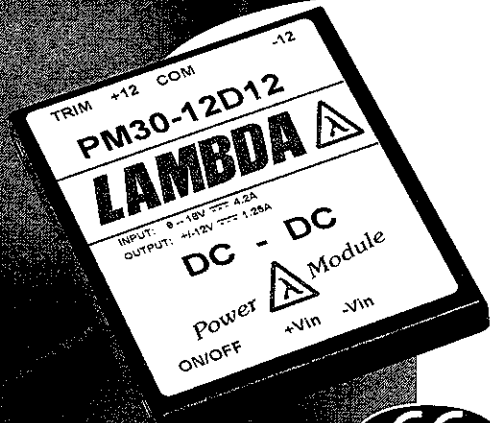

10-30

WATTS

DC/DC CONVERTERS

SINGLE, DUAL OR TRIPLE OUTPUT

Industry standard footprints

Profile: 8.5mm

Telecom compliant: Bellcore, ETSI, FCC

Wide range of voltage inputs

Wide operating temperature range

2 year guarantee

ELECTRICAL SPECIFICATIONS

Volts	Amp.	Watts	Model		
			Input 12V	Input 24V	Input 48V
Single output					
3.3	2.55	8.4	PM10-12S03	PM10-24S03	PM10-48S03
3.3	5.00	16.5	PM20-12S03	PM20-24S03	PM20-48S03
3.3	7.50	24.75	PM30-12S03	PM30-24S03	PM30-48S03
5.0	2.00	10	PM10-12S05	PM10-24S05	PM10-48S05
5.0	4.00	20	PM20-12S05	PM20-24S05	PM20-48S05
5.0	6.00	30	PM30-12S05	PM30-24S05	PM30-48S05
12.0	0.83	10	PM10-12S12	PM12-24S12	PM10-48S12
12.0	1.67	20	PM20-12S12	PM20-24S12	PM20-48S12
12.0	2.50	30	PM30-12S12	PM30-24S12	PM30-48S12
15.0	0.67	10	PM10-12S15	PM10-24S15	PM10-48S15
15.0	1.33	20	PM20-12S15	PM20-24S15	PM20-48S15
15.0	2.00	30	PM30-12S15	PM30-24S15	PM30-48S15

Volts	Amp.	Watts	Model		
			Input 12V	Input 24V	Input 48V
Dual output					
±12	0.42	10	PM10-12D12	PM10-24D12	PM10-48D12
±12	0.83	20	PM20-12D12	PM20-24D12	PM20-48D12
±12	1.25	30	PM30-12D12	PM30-24D12	PM30-48D12
±15	0.33	10	PM10-12D15	PM10-24D15	PM10-48D15
±15	0.67	20	PM20-12D15	PM20-24D15	PM20-48D15
±15	1.00	30	PM30-12D15	PM30-24D15	PM30-48D15
Triple output					
3.3,±12	7,±1	30	PM30-12T03-12	PM30-24T03-12	PM30-48T03-12
5,±12	5,±1	30	PM30-12T05-12	PM30-24T05-12	PM30-48T05-12

PHYSICAL SPECIFICATIONS

PM 10
single output

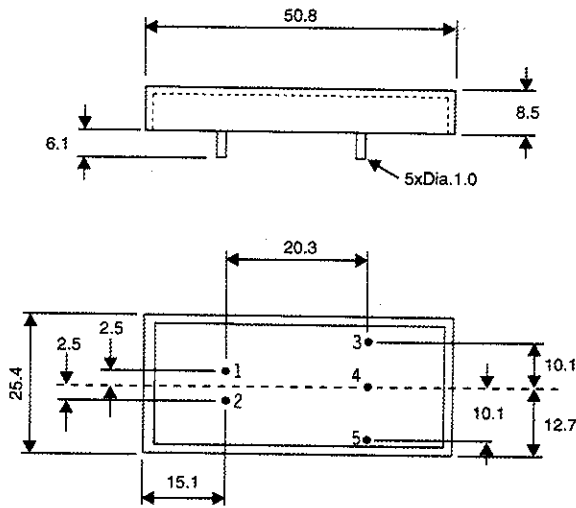

PM 10
dual output

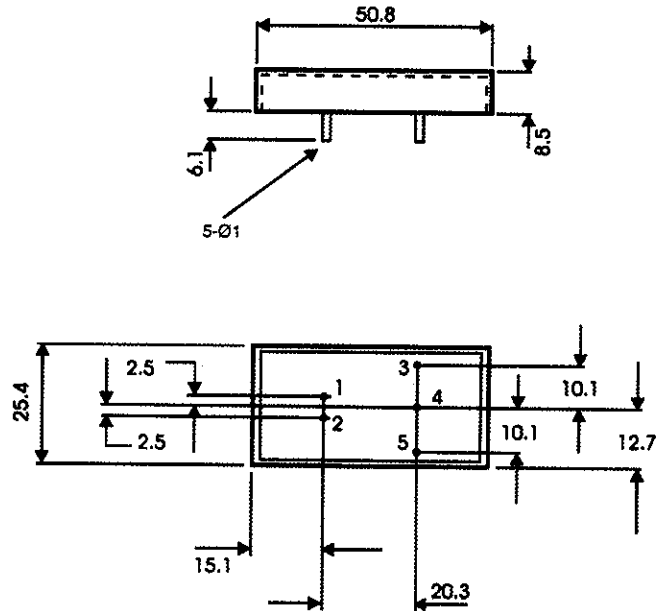

Connection

Single output	Dual output
Pin 1 +Vin	Pin 1 +Vin
Pin 2 -Vin	Pin 2 -Vin
Pin 3 +Vo	Pin 3 +Vo
Pin 4 NC	Pin 4 COM
Pin 5 -Vo	Pin 5 -Vo

NB. Products viewed from below, not above.

Series PM

LAMBDA
An Invensys company

EDITION 2001

PM 20

single/dual output

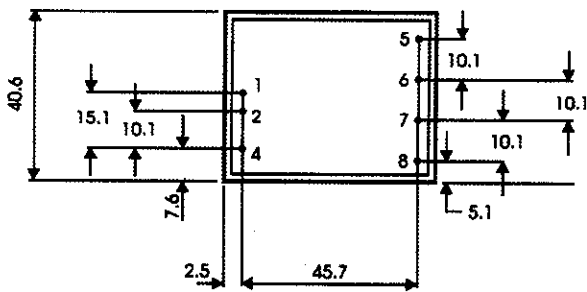
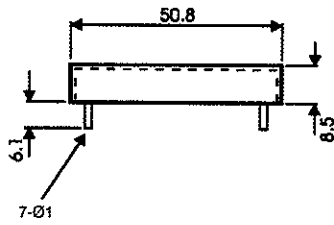

Connection

Single output	Dual output
Pin 1 +Vin	Pin 1 +Vin
Pin 2 -Vin	Pin 2 -Vin
Pin 4 ON/OFF	Pin 4 ON/OFF
Pin 5 NC	Pin 5 +Vo
Pin 6 +Vo	Pin 6 COM
Pin 7 -Vo	Pin 7 -Vo
Pin 8 TRIM	Pin 8 TRIM

PM 30

single/dual/triple output

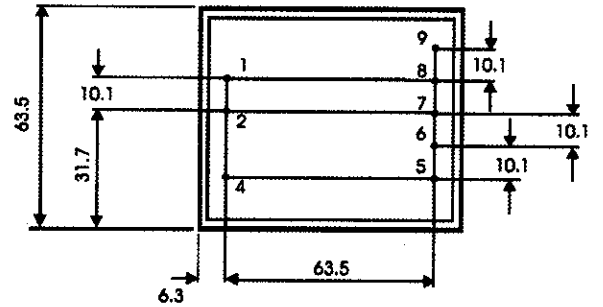
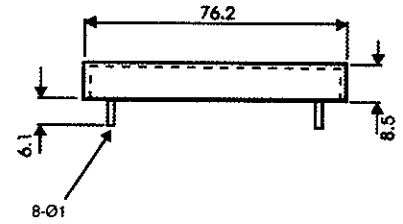

Connection

Single output	Dual output	Triple output
Pin 1 +Vin	Pin 1 -Vin	Pin 1 -Vin
Pin 2 -Vin	Pin 2 +Vin	Pin 2 +Vin
Pin 4 ON/OFF	Pin 4 ON/OFF	Pin 4 ON/OFF
Pin 5 TRIM	Pin 5 TRIM	Pin 5 TRIM
Pin 6 +Vo	Pin 6 +Vo	Pin 6 5V/3.3V
Pin 7 -Vo	Pin 7 COM	Pin 7 COM
Pin 8 NC	Pin 8 NC	Pin 8 +12V
Pin 9 NC	Pin 9 -Vo	Pin 9 -12V

NB. Products viewed from below, not above.