

December 1993

CMOS Analog Switches

Features

- Analog Signal Range ($\pm 15V$ Supplies) $\pm 15V$
- Low Leakage 40pA
- Low On Resistance 35 Ω
- Break-Before-Make Delay 60ns
- Charge Injection 30pC
- TTL Compatible
- Symmetrical Switch Elements
- Low Operating Power 1.0mW

Applications

- Sample and Hold (i.e. Low Leakage Switching)
- Op Amp Gain Switching (i.e. Low On Resistance)
- Portable, Battery Operated Circuits
- Low Level Switching Circuits
- Dual or Single Supply Systems

Description

The HI-381 thru HI-390 series of switches are monolithic devices fabricated using CMOS technology and the Harris dielectric isolation process. These devices are TTL compatible and are available in four switching configurations. (See device pinout for particular switching function with a logic "1" input.)

These switches feature low leakage and supply currents, low and nearly constant ON resistance over the analog signal range, break-before-make switching and low power dissipation.

The HI-381 and HI-387 switches are available in a 14 lead Plastic, Ceramic DIP, or 10 pin Metal Can. The HI-384 and HI-390 are available in a 16 lead Plastic or Ceramic DIP. Each of the individual switch types are available in the -55°C to +125°C, -40°C to +85°C, or 0°C to +75°C operating ranges.

Pinouts (Switch States are for a Logic "1" Input)

DUAL SPST HI-381
TOP VIEWS

(CDIP, PDIP, SOIC)

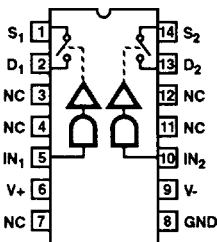

(METAL CAN)

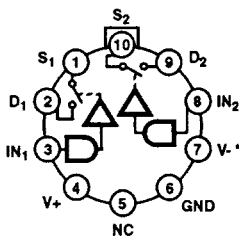

LOGIC	SWITCH
0	OFF
1	ON

* The substrate and case are internally tied to V-. (The case should not be used as the V- connection, however.)

SPDT HI-387
TOP VIEWS

(CDIP, PDIP, SOIC)

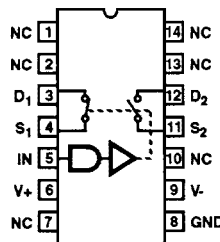

(METAL CAN)

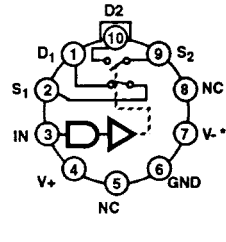

LOGIC	SW1	SW2
0	OFF	ON
1	ON	OFF

* The substrate and case are internally tied to V-. (The case should not be used as the V- connection, however.)

DUAL DPST HI-384 (CDIP, PDIP, SOIC)
TOP VIEW

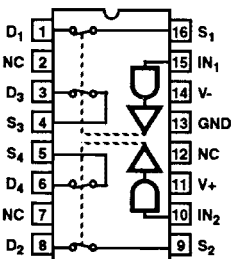

LOGIC	SW 1 - 4
0	OFF
1	ON

DUAL SPDT HI-390 (CDIP, PDIP, SOIC)
TOP VIEW

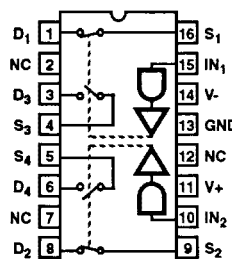

LOGIC	SW1	SW2	SW3	SW4
0	OFF	OFF	ON	ON
1	ON	ON	OFF	OFF

HI-381 thru HI-390

Ordering Information

PART NUMBER	TEMPERATURE RANGE	PACKAGE
HI1-0381-2	-55°C to +125°C	14 Lead Ceramic DIP
HI1-0381-5	0°C to +75°C	14 Lead Ceramic DIP
HI1-0381/883	-55°C to +125°C	14 Lead Ceramic DIP
HI2-0381-2	-55°C to +125°C	10 Pin TO-5 Metal Can
HI2-0381-5	0°C to +75°C	10 Pin TO-5 Metal Can
HI2-0381/883	-55°C to +125°C	10 Pin TO-5 Metal Can
HI1-0384-2	-55°C to +125°C	16 Lead Ceramic DIP
HI1-0384-5	0°C to +75°C	16 Lead Ceramic DIP
HI1-0384/883	-55°C to +125°C	16 Lead Ceramic DIP
HI9P0384-5	0°C to +75°C	16 Lead Plastic SOIC (W)
HI1-0387-2	-55°C to +125°C	14 Lead Ceramic DIP
HI1-0387-5	0°C to +75°C	14 Lead Ceramic DIP
HI2-0387-2	-55°C to +125°C	10 Pin TO-5 Metal Can
HI2-0387-5	0°C to +75°C	10 Pin TO-5 Metal Can
HI9P0387-5	0°C to +75°C	14 Lead Plastic SOIC
HI1-0390-2	-55°C to +125°C	16 Lead Ceramic DIP
HI1-0390-5	0°C to +75°C	16 Lead Ceramic DIP
HI1-0390/883	-55°C to +125°C	16 Lead Ceramic DIP
HI9P0390-5	0°C to +75°C	16 Lead Plastic SOIC (W)
HI3-0381-5	0°C to +75°C	14 Lead Plastic DIP
HI9P0381-5	0°C to +75°C	14 Lead Plastic SOIC
HI9P0381-9	-40°C to +85°C	14 Lead Plastic SOIC
HI1-0387/883	-55°C to +125°C	14 Lead Ceramic DIP
HI2-0387/883	-55°C to +125°C	10 Pin TO-5 Metal Can
HI3-0387-5	0°C to +75°C	14 Lead Plastic DIP
HI9P0387-9	-40°C to +85°C	14 Lead Plastic SOIC
HI3-0390-5	0°C to +75°C	16 Lead Plastic DIP
HI3-0390-9	-40°C to +85°C	16 Lead SOIC (W)
HI3-0384-5	0°C to +75°C	16 Lead Plastic DIP
HI3-0384-9	-40°C to +85°C	16 Lead SOIC (W)

Functional Block Diagram

TYPICAL SWITCH 3XX SERIES

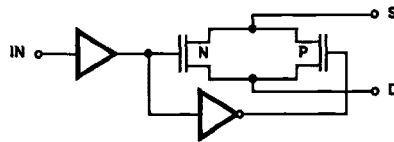

Schematic Diagrams

SWITCH CELL

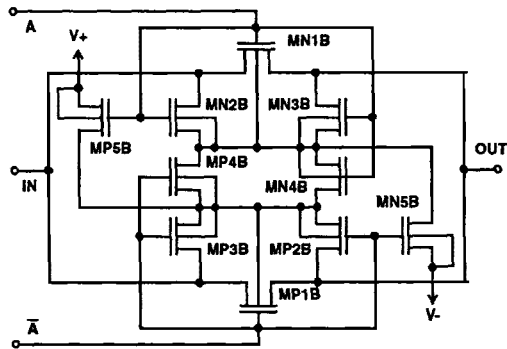

DIGITAL INPUT BUFFER AND LEVEL SHIFTER

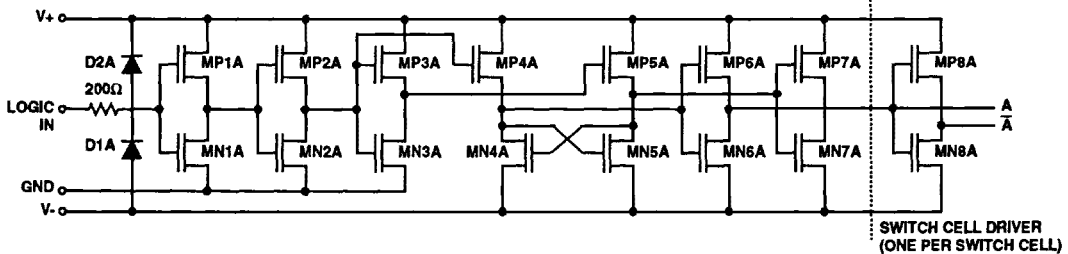

Specifications HI-381 thru HI-390

Absolute Maximum Ratings

Voltage Between Supplies	44V (± 22 V)
Digital Input Voltage	+V _{SUPPLY} +4V -V _{SUPPLY} -4V
Analog Input Voltage	+V _{SUPPLY} +1.5V -V _{SUPPLY} -1.5V
Storage Temperature Range	-65°C to +150°C
Lead Temperature (Soldering 10s).....	+300°C

Thermal Information

Thermal Resistance	θ_{JA}	θ_{JC}
Ceramic DIP Package, 14 Lead	95°C/W	24°C/W
Ceramic DIP Package, 16 Lead	80°C/W	24°C/W
Plastic DIP Package, 14 Lead	100°C/W	-
Plastic DIP Package, 16 Lead	100°C/W	-
Plastic SOIC Package, 14 Lead	120°C/W	-
Plastic SOIC Package, 16 Lead	100°C/W	-
Metal Can Package	136°C/W	65°C/W
Junction Temperature		
Ceramic DIP	+175°C	
Plastic DIP	+150°C	
Plastic SOIC	+150°C	
Metal Can	+175°C	
Operating Temperature Range		
HI-3XX-2	-55°C to +125°C	
HI-3XX-5	0°C to +75°C	
HI-3XX-9	-40°C to +85°C	

CAUTION: Stresses above those listed in "Absolute Maximum Ratings" may cause permanent damage to the device. This is a stress only rating and operation of the device at these or any other conditions above those indicated in the operational sections of this specification is not implied.

Electrical Specifications Supplies = +15V, -15V; V_{IN} = Logic Input. V_{IN} for Logic "1" = 4V, for Logic "0" = 0.8V, Unless Otherwise Specified.

PARAMETERS	TEST CONDITIONS	TEMP	HI-3XX-2			HI-3XX-5-9			UNITS
			MIN	TYP	MAX	MIN	TYP	MAX	
SWITCHING CHARACTERISTICS									
Break-Before-Make Delay, t _{OPEN} (HI-387/HI-390 Only)		+25°C	-	60	-	-	60	-	ns
Switch On Time, t _{ON}		+25°C	-	210	300	-	210	300	ns
Switch Off Time, t _{OFF}		+25°C	-	160	250	-	160	250	ns
"Off Isolation"	(Note 5)	+25°C	-	60	-	-	60	-	dB
Charge Injection	(Note 6)	+25°C	-	3	-	-	3	-	mV
Input Switch Capacitance, C _{S(OFF)}		+25°C	-	16	-	-	16	-	pF
Output Switch Capacitance, C _{D(OFF)}		+25°C	-	14	-	-	14	-	pF
Output Switch Capacitance, C _{D(ON)}		+25°C	-	35	-	-	35	-	pF
Digital Input Capacitance (High), C _{IN}		+25°C	-	5	-	-	5	-	pF
Digital Input Capacitance (Low), C _{IN}		+25°C	-	5	-	-	5	-	pF
DIGITAL INPUT CHARACTERISTICS									
Input Low Level, V _{INL}		Full	-	-	0.8	-	-	0.8	V
Input High Level, V _{INH}		Full	4	-	-	4	-	-	V
Input Leakage Current (Low), I _{INL}	(Note 4)	Full	-	-	1	-	-	1	μA
Input Leakage Current (High), I _{INH}	(Note 4)	Full	-	-	1	-	-	1	μA
ANALOG SWITCH CHARACTERISTICS									
Analog Signal Range		Full	-15	-	+15	-15	-	+15	V
On Resistance, R _{ON}	(Note 1)	+25°C	-	35	50	-	35	50	Ω
		Full	-	40	75	-	45	75	Ω
Off Input Leakage Current, I _{S(OFF)}	(Note 2)	+25°C	-	0.04	1	-	0.04	5	nA
		Full	-	1	100	-	0.2	100	nA
Off Output Leakage Current, I _{D(OFF)}	(Note 2)	+25°C	-	0.04	1	-	0.04	5	nA
		Full	-	1	100	-	0.2	100	nA
On Input Leakage Current, I _{S(ON)}	(Note 3)	+25°C	-	0.03	1	-	0.03	5	nA
		Full	-	0.5	100	-	0.2	100	nA

Specifications HI-381 thru HI-390

Electrical Specifications Supplies = +15V, -15V; V_{IN} = Logic Input. V_{IN} for Logic "1" = 4V, for Logic "0" = 0.8V, Unless Otherwise Specified. (Continued)

PARAMETERS	TEST CONDITIONS	TEMP	HI-3XX-2			HI-3XX-5-9			UNITS
			MIN	TYP	MAX	MIN	TYP	MAX	
POWER SUPPLY CHARACTERISTICS									
Current, I_+	(Note 7)	+25°C	-	0.09	0.5	-	0.09	0.5	mA
		Full	-	-	1	-	-	1	mA
Current, I_-	(Note 7)	+25°C	-	0.01	10	-	0.01	100	μ A
		Full	-	-	100	-	-	-	μ A
Current, I_+	(Note 8)	+25°C	-	0.01	10	-	0.01	100	μ A
		Full	-	-	100	-	-	-	μ A
Current, I_-	(Note 8)	+25°C	-	0.01	10	-	0.01	100	μ A
		Full	-	-	100	-	-	-	μ A

NOTES:

- $V_S = \pm 10V$, $I_{OUT} = \pm 10mA$. On resistance derived from the voltage measured across the switch under the above conditions.
- $V_S = \pm 14V$, $V_D = \pm 14V$.
- $V_S = V_D = \pm 14V$.
- The digital inputs are diode protected MOS gates and typical leakages of 1nA or less can be expected.
- $V_S = 1V_{RMS}$, $f = 500kHz$, $C_L = 15pF$, $R_L = 1K$, $C_L = C_{FIXTURE} + C_{PROBE}$ "off isolation" = $20 \log V_S/V_D$.
- $V_S = 0V$, $C_L = 10,000pF$, Logic Drive = 5V pulse. Switches are symmetrical; S and D may be interchanged.
- $V_{IN} = 4V$ (one input) (all other inputs = 0V).
- $V_{IN} = 0.8V$ (all inputs).

Typical Performance Curves

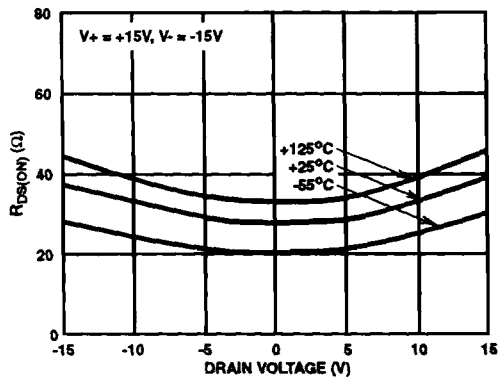

FIGURE 1. $R_{DS(ON)}$ vs V_D AND TEMPERATURE

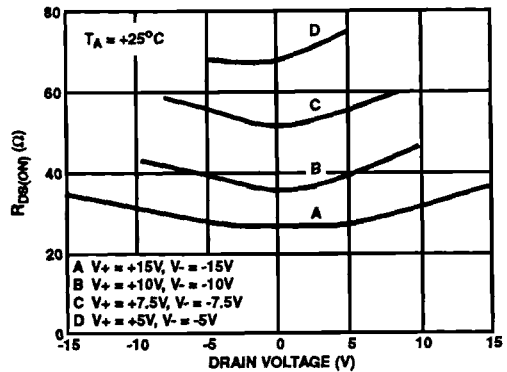

FIGURE 2. $R_{DS(ON)}$ vs V_D AND POWER SUPPLY VOLTAGE

Typical Performance Curves (Continued)

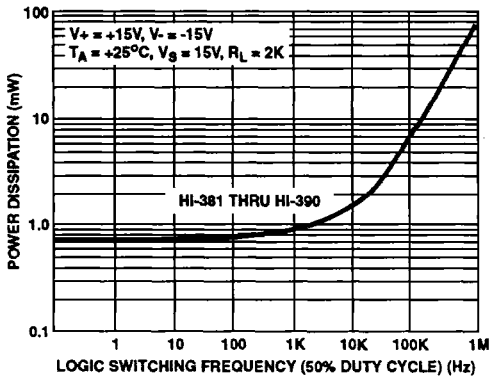

FIGURE 3. DEVICE POWER DISSIPATION vs SWITCHING FREQUENCY (SINGLE LOGIC INPUT)

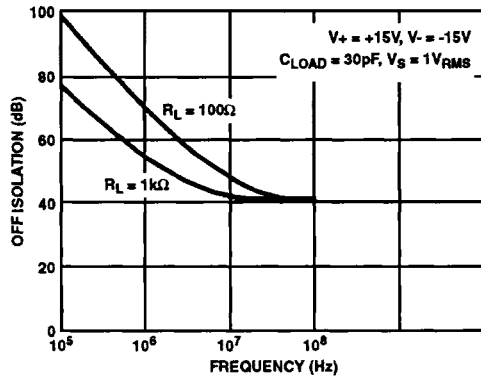

FIGURE 4. OFF ISOLATION vs FREQUENCY

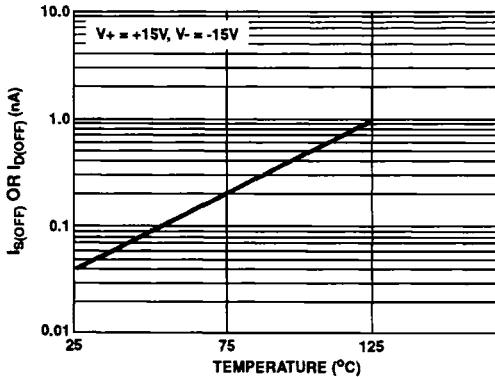

FIGURE 5. $I_{S(OFF)}$ OR $I_{D(OFF)}$ vs TEMPERATURE*

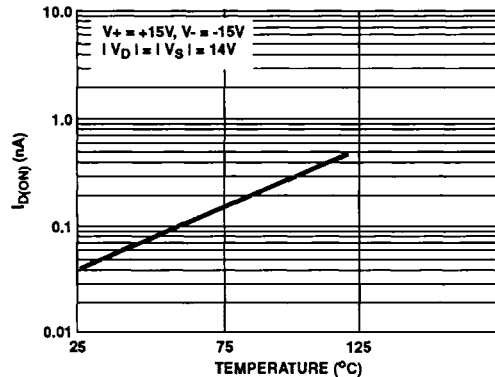

FIGURE 6. $I_{D(ON)}$ vs TEMPERATURE*

* The net leakage into the source or drain is the n-channel leakage minus the p-channel leakage. This difference can be positive, negative or zero depending on the analog voltage and temperature, and will vary greatly from unit to unit.

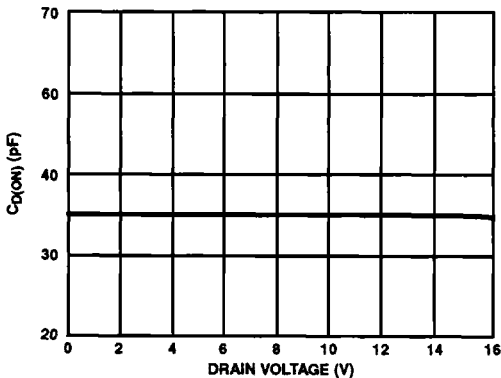

FIGURE 7. OUTPUT ON CAPACITANCE vs DRAIN VOLTAGE

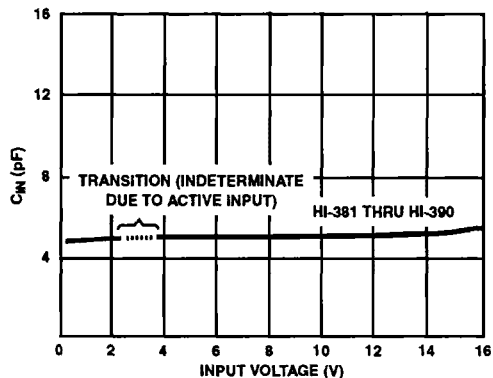
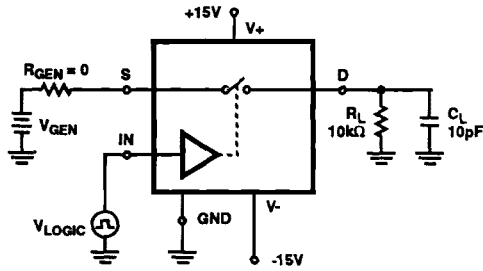
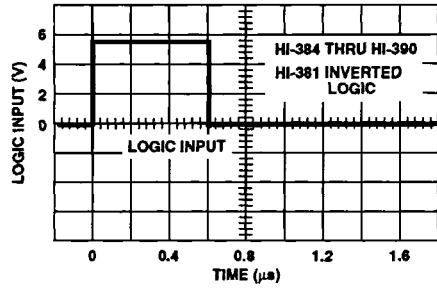

FIGURE 8. DIGITAL INPUT CAPACITANCE vs INPUT VOLTAGE

Typical Performance Curves (Continued)



9A. TEST CIRCUIT



9B. V_{IN} LOGIC vs TIME

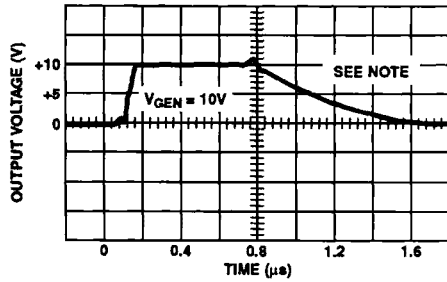

9C. V_{OUT} vs TIME

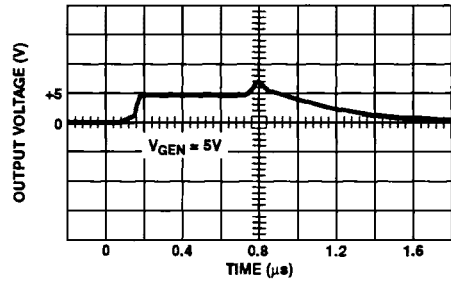

9D. V_{OUT} vs TIME

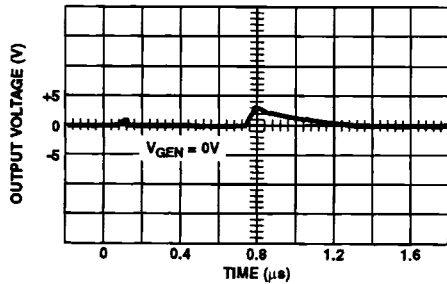

9E. V_{OUT} vs TIME

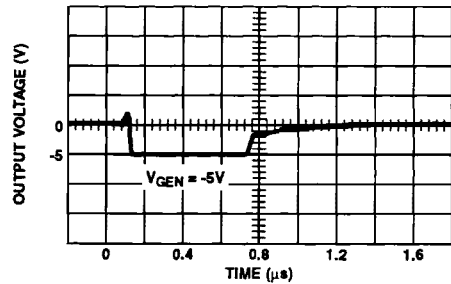

9F. V_{OUT} vs TIME

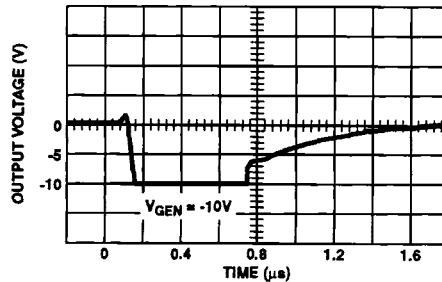

9G. V_{OUT} vs TIME

NOTE: If R_{GEN} , R_L or C_L is increased, there will be proportional increases in rise and/or fall RC times.

FIGURE 9. TYPICAL DELAY, RISE, FALL, SETTLING TIMES AND SWITCHING TRANSIENTS

Typical Performance Curves (Continued)

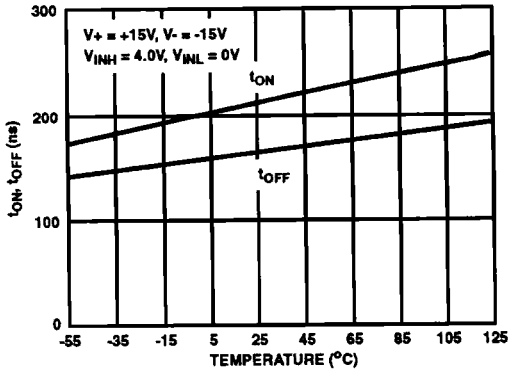

FIGURE 10. SWITCHING TIME vs TEMPERATURE, HI-381 THRU HI-390

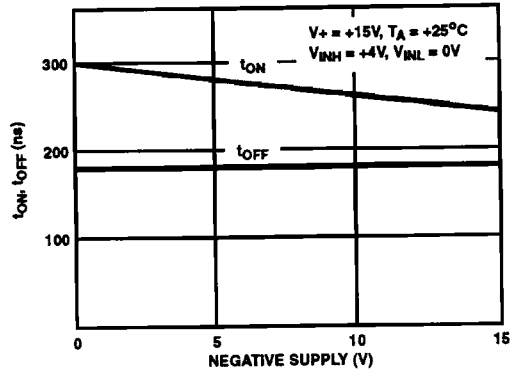

FIGURE 11. SWITCHING TIME vs NEGATIVE SUPPLY VOLTAGE, HI-381 THRU HI-390

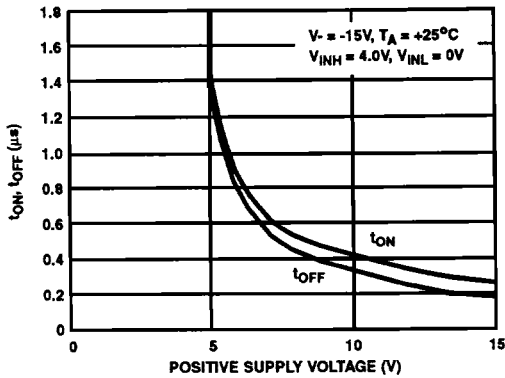

FIGURE 12. SWITCHING TIME vs POSITIVE SUPPLY VOLTAGE, HI-381 THRU HI-390

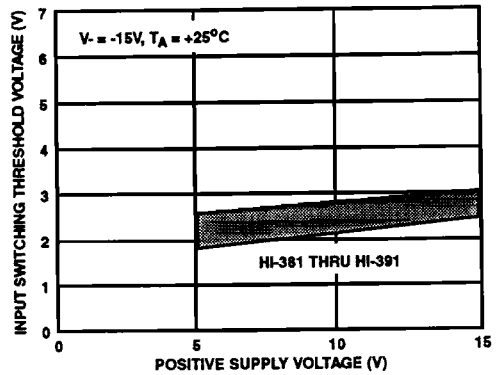

FIGURE 13. INPUT SWITCHING THRESHOLD vs POSITIVE SUPPLY VOLTAGE, HI-381 THRU HI-390