



# AK1291

## IF Variable Gain Amplifier with RSSI

### 1. Overview

AK1291 is a variable gain amplifier with a power detector. It's operating frequency ranges from 90MHz to 300MHz. The gain control adopts an analog signal control, and the gain characteristic is dB linear. The gain control range is -9dB to +21dB and a dynamic range is 30dB. AK1291 has single-ended input and output, with impedance of 50  $\Omega$ . As a typical characteristic, NF is 7dB (at maximum gain), and IMD3 is 70dBc at output power of -15dBm, at frequency of 165MHz. The power supply voltage is 4.75V to 5.25V.

### 2. Feature

▪Operation Frequency Range	90MHz to 300MHz
▪Gain variable range	-9dB to 21dB
▪Noise Figure	7dB @max gain
▪IMD3	70dBc @output power -15dBm
▪Supply Voltage	4.75V to 5.25V
▪Operating Temperature	-40°C to +85°C
▪Package	24pin QFN0404

### 3. Block Diagram

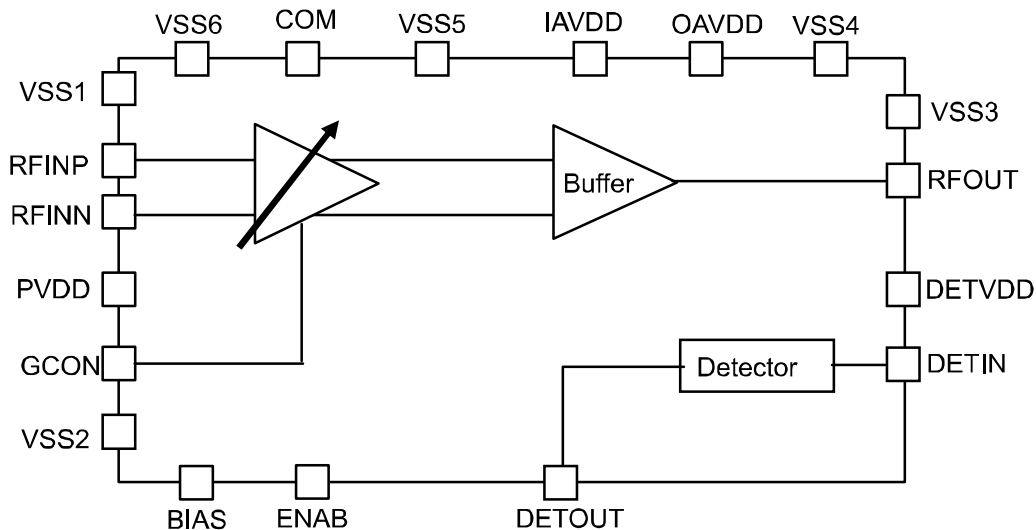
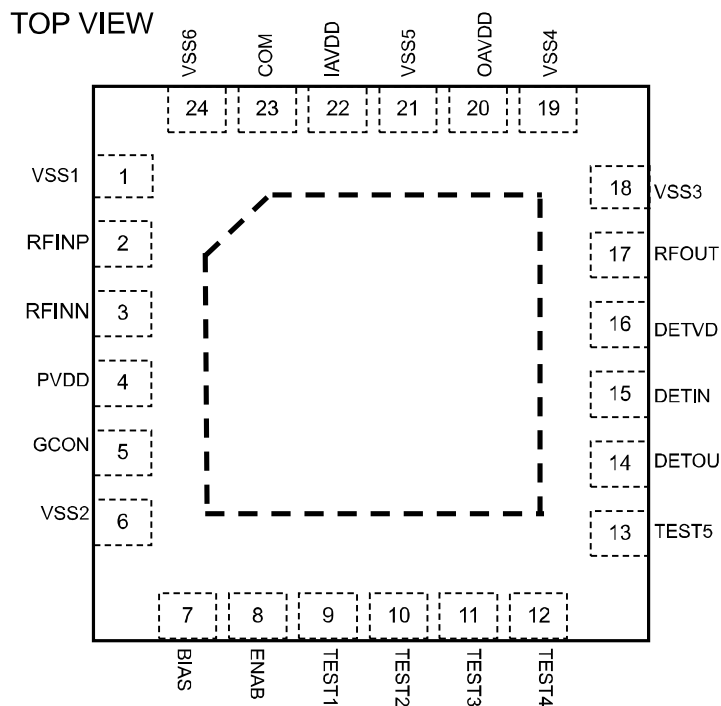

Figure. 1 Block Diagram

## Contents

1. Overview.....	1
2. Feature .....	1
3. Block Diagram.....	1
4. Pin Configuration.....	3
5. Pin function Description .....	4
6. Maximum Absolute Rating.....	5
7. Recommended operational condition.....	5
8. Electrical Characteristic.....	6
9. Interface circuit.....	8
10. Evaluation Board Schimatic .....	10
11. Typical Performance.....	12
12. Marking.....	14
13. Outer Dimensions .....	15

**4. Pin Configuration**



**Figure. 2 Pin Configuration**

**5. Block Function**

Block	Function
VGA	Variable Gain Amplifier which is controlled by the voltage of 0.2 to 2.5V
Power Detector	Power detector which detect power level of VGA output

<b>6. Pin function Description</b>
------------------------------------

Pin No	Name	I/O	function	Remark
1	VSS1	G	Ground	
2	RFINP	AI	RF input Positive	
3	RFINN	AI	RF input Negative	
4	PVDD	P	Power Supply	
5	GCON	AI	Control voltage input	
6	VSS2	G	Ground	
7	BIAS	AIO	Resistance connection pin for current adjustment	No resistance is connected.
8	ENAB	DI	Power down control	ENAB="High" Power on ENAB="Low" Power down
9	TEST1	DI	Test pin	Connect to ground
10	TEST2	DI	Test pin	Connect to ground
11	TEST3	DI	Test pin	Connect to ground
12	TEST4	DI	Test pin	Connect to ground
13	TEST5	DO	Test pin	Connectionless
14	DETOUT	AO	Detector output	connect a capacitor of 10pF to ground
15	DETIN	AI	Detector input	
16	DETVDD	P	Power supply	
17	RFOUT	AO	RF output	
18	VSS3	G	Ground	
19	VSS4	G	Ground	
20	OAVDD	P	Power supply	
21	VSS5	G	Ground	
22	IAVDD:	P	Power supply	
23	COM	AIO	Pin for input common voltage	connect a capacitor of 10nF to ground
24	VSS6	G	Ground	
25	EXPAD	G	Ground	The exposed pad at the center of the backside should be connected to ground.

Note) the exposed pad at the center of the backside should be connected to ground.

AI:Analog input pin	AO:Analog output pin	DI: Digital Input pin	DO:Digital Output pin
P: Power supply pin	G: Ground pin		

\* About power down control: The power down of the whole IC is done by ENAB (pin8). In the case that ENAB is "High", VGA block and Detector block are power on state. In the case that let only Detector block power down, connect DETVDD to the ground.

## 7. Absolute Maximum Rating

Item	Symbol	Min.	Max.	unit	Remarks
Supply Voltage	VDD	-0.3	5.5	V	Applied to [PVDD],[IAVDD],[OAVDD],[DETVDD] note1)
Ground Level	VSS	0	0	V	Applied to[VSS1], [VSS2],[VSS3], [VSS4],[VSS5],[VSS6] and [EXPAD]
Analog input voltage	VAIN	-0.3	VDD+0.3	V	Applied to [RFINP],[RFINN],[GCON] and [DETIN]
	VDIN	-0.3	VDD+0.3	V	Applied to [ENAB] note1)
RFINP/RFINN Maximum input Level	Pmax		+10	dBm	
Storage Temperature	Tstg	-55	125	°C	

Note1) All voltage reference ground Level: 0V

Exceeding these maximum ratings may result in damage to the AK1291. Normal operation is not guaranteed at these extremes

## 8. Recommended operational condition

Item	Symbol	Min.	Typ.	Max.	unit	Remarks
Operating Temperature	Ta	-40		85	°C	
Supply Voltage	VDD	4.75	5	5.25	V	Applied to [PVDD],[IAVDD],[OAVDD],and [DETVDD]

Each specification is applied in the power supply voltage and the operating temperature applied to recommended operational condition.

## 9. Electrical Characteristic

### DC Characteristic

Item	Symbol	Condition	Min.	Typ.	Max.	Unit
High Level Input Voltage	V <sub>IH</sub>	Note1)	0.8*VDD			V
Low Level Input Voltage	V <sub>IL</sub>	Note1)	0.0		0.2*VDD	V
Input leak current	I <sub>IL</sub>	Note1)	-10		10	μA
Current consumption 1	ICC1	PVDD=OAVDD=IAVDD=DET VDD=VDD, ENAB=High		155	199	mA
Current consumption 2	ICC2	PVDD=OAVDD=IAVDD=VDD, DET VDD=VSS, ENAB=High		151	195	mA
Current consumption 3	ICC3	PVDD=OAVDD=IAVDD=VDD, DET VDD=VSS, ENAB=Low		10		μA

Note1) Applied to [ENAB] pin

### AC Characteristic

PVDD=OAVDD=IAVDD=4.75V~5.25V, Ta=-40°C~85°C f<sub>0</sub>=165MHz, unless otherwise specified

Item	Symbol	Condition	Min.	Typ.	Max.	Unit
<b>VGA Block</b>						
Input Frequency	F <sub>OP</sub>		90		300	MHz
Input Impedance	I <sub>IMP</sub>			50		Ω
Output Impedance	O <sub>IMP</sub>			50		Ω
Gain control Range	G <sub>CONT</sub>			30		dB
Max. Gain	G <sub>MAX</sub>	GCON=2.5V	21			dB
Min. Gain	G <sub>MIN</sub>	GCON=0.2V			-6.5	dB
Gain 1	Ga1	GCON=2V		21		dB
Gain 2	Ga2	GCON=0.5V		-9		dB
Gain control voltage range	V <sub>GT</sub>		0.2		2.5	V
Gain curve slope note1)	G <sub>CS</sub>	0.5V ≤ VGCONT ≤ 2.0V	1	20	80	dB/V
Gain step response	G <sub>SR</sub>			5		μS
<b>&lt;RFIN=90MHz&gt;</b>						
Noise Figure note2)	NF	Gain = 21 dB		7		dB
Output P1dB	OP1			5		dBm
IMD3	IMD3	Output Level = -15dBm	65	70		dBc
<b>&lt;RFIN=165MHz&gt;</b>						
Noise Figure note2)	NF	Gain = 21 dB		7		dB
Output P1dB	OP1			5		dBm
IMD3	IMD3	Output Level = -15dBm	65	70		dBc
<b>&lt;RFIN=300MHz&gt;</b>						
Noise Figure note2)	NF	Gain = 21 dB		7		dB
Output P1dB	OP1			5		dBm
IMD3	IMD3	Output Level = -15dBm	55	60		dBc

Detector Block						
Input Frequency range	F <sub>OP2</sub>		100		500	MHz
Output voltage Level 1	Det_H	DETIN=-15dBm		1.6	2.2	V
Output voltage Level 2	Det_L	DETIN=-35dBm	0.5	0.9		V
Temperature dependency note 2)	Detvdev	Refer to 25°C		±1		dB

Note1) guaranteed monotonicity

Note2) guaranteed by design

**10. Interface circuit**

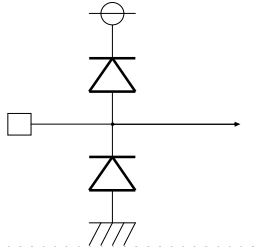
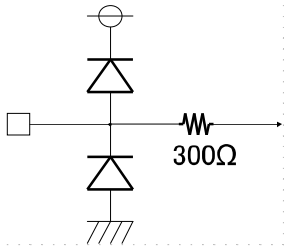
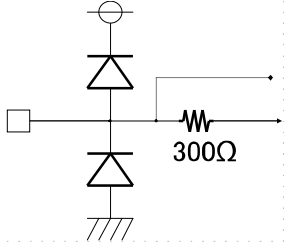
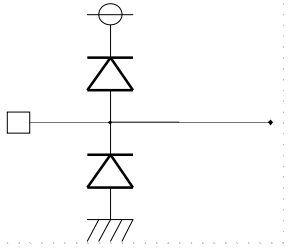
Pin No	Pin Name	I/O	Interface circuit
2	RFINP	I	<b>RF input</b> 
3	RFINN		
5	GCON	I	<b>Analog Input</b> 
7	BIAS	I/O	<b>Analog Input/Output</b> 
23	COM		
17	RFOUT	O	<b>RF output</b> 

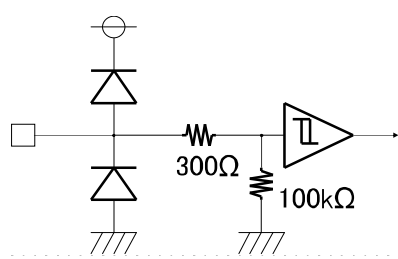
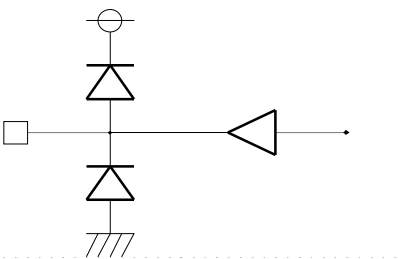
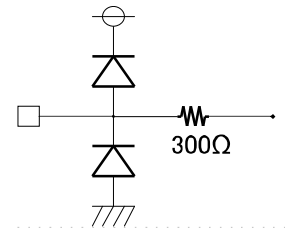
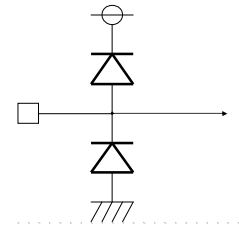

Pin No.	Pin Name	I/O	Interface Circuit
8	ENAB	I	<b>Digital input Pull-Down</b>  
9	TEST1		
10	TEST2		
11	TEST3		
12	TEST4		
13	TEST5	O	<b>Digital output</b>  
14	DETOUT	O	<b>Output</b>  
15	DETIN	I	<b>RF input</b>  

**11. Evaluation Board Schimatic**

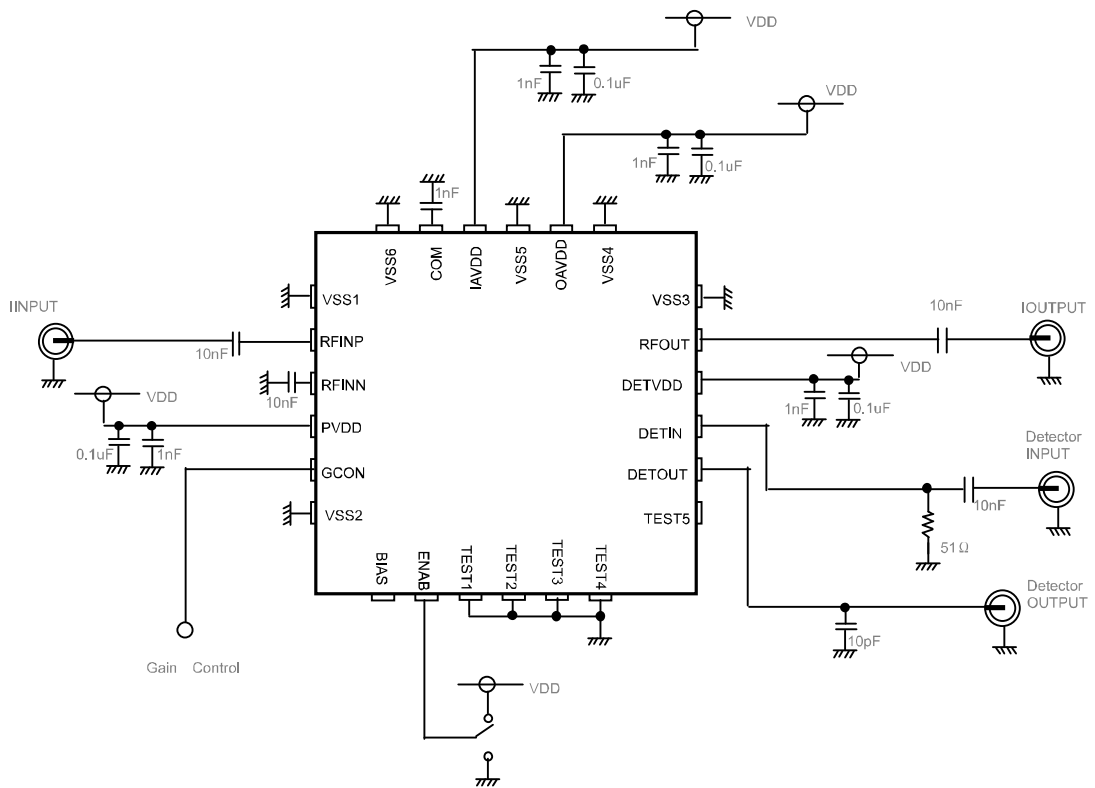

**Figure. 3 Typical Evaluation Board Schimatic**

**12. Detection of the output signal level**

To detect the output power , connect “RFOUT” to “DETIN” via register.  
 The value of register varies depending on the detection level.  
 Circuit schematic and the value of register are shown in figure 4.

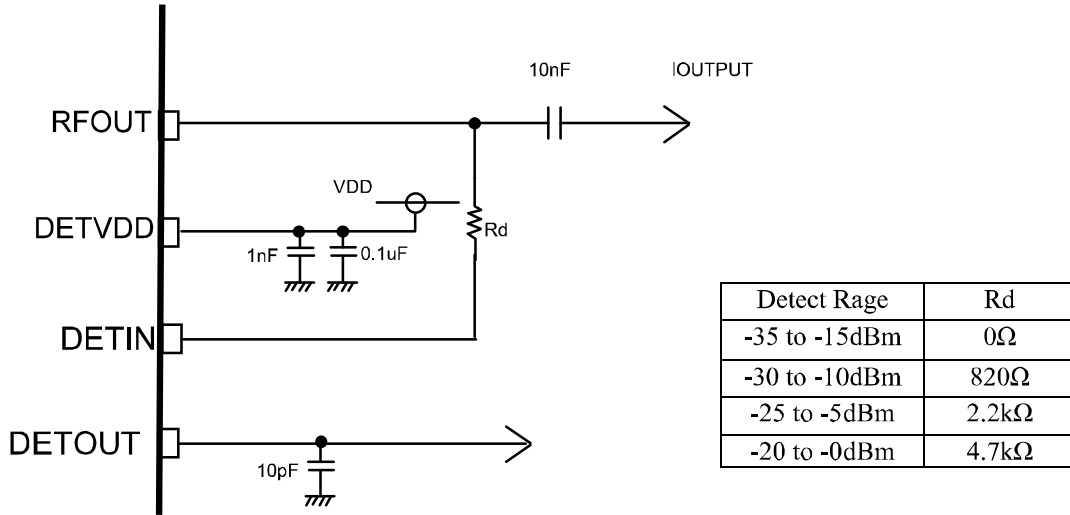

**Figure. 4 Circuit schematic of VGA output and detector input**

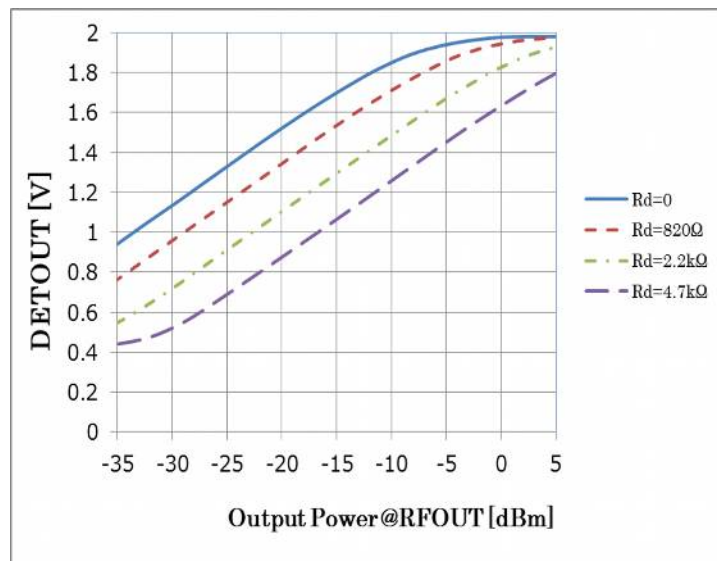
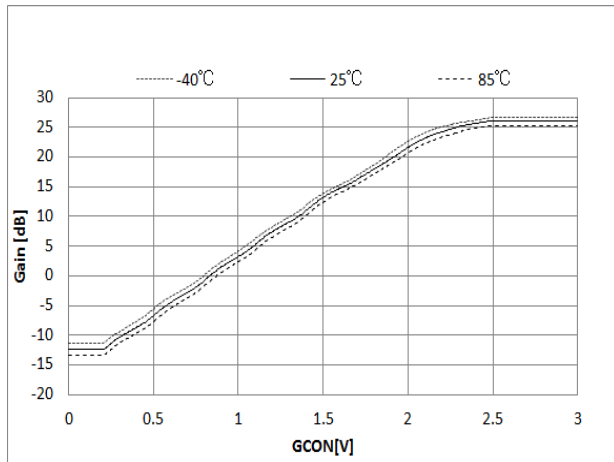

**Figure. 5 DETOUT vs Output Power@RFOUT**

**13. Typical Performance**

Unless otherwise noted, PVDD=OAVDD=IAVDD=DETVDD=5V, Ta=25°C, Freq=165MHz

**1. Gain vs Analog Control Voltage**



**Figure.6-1 Gain VS Control Voltage(fo=100MHz)**

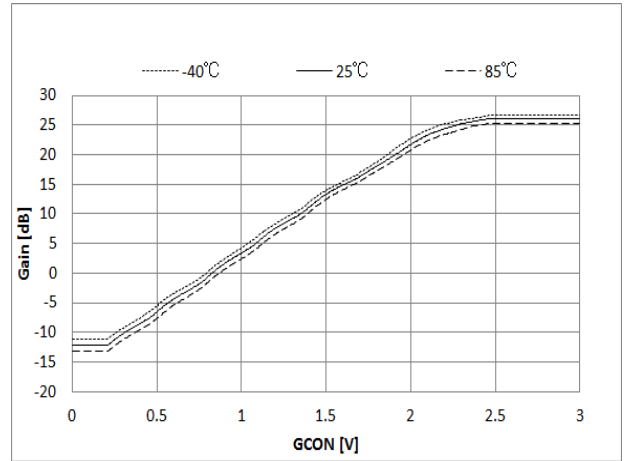

**Figure.6-1 Gain VS Control Voltage(fo=165MHz)**

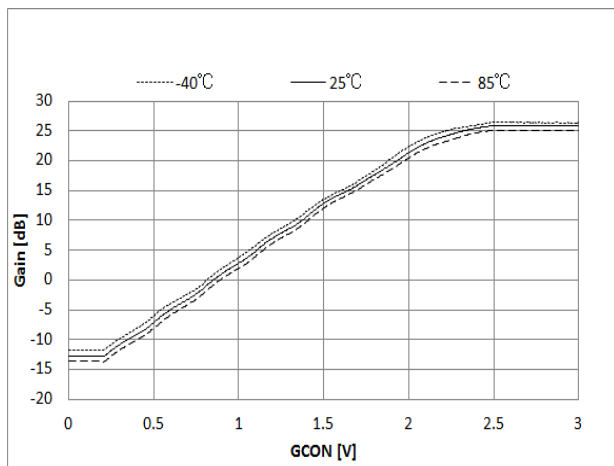

**Figure.6-1 Gain VS Control Voltage(fo=300MHz)**

## 2. Noise Figure

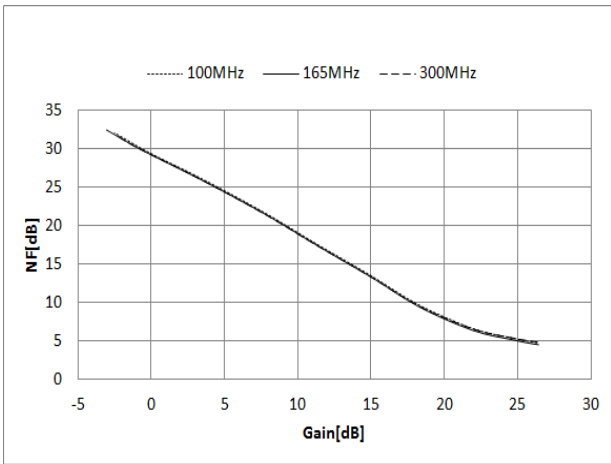

Figure.7-1 NF VS Gain (Temp =25°C)

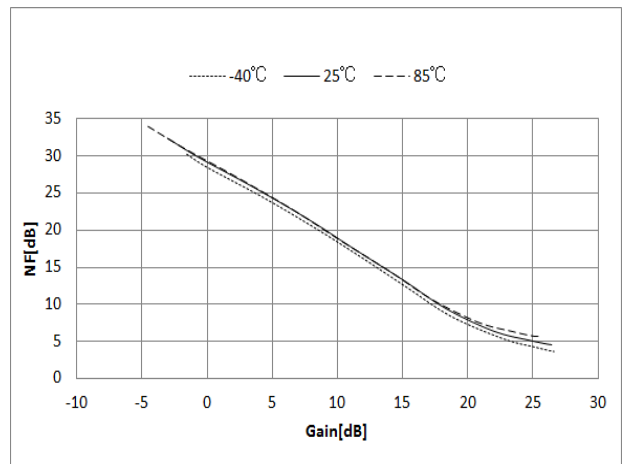

Figure.7-2 NF VS Gain (fo=165MHz)

## 3. IMD3

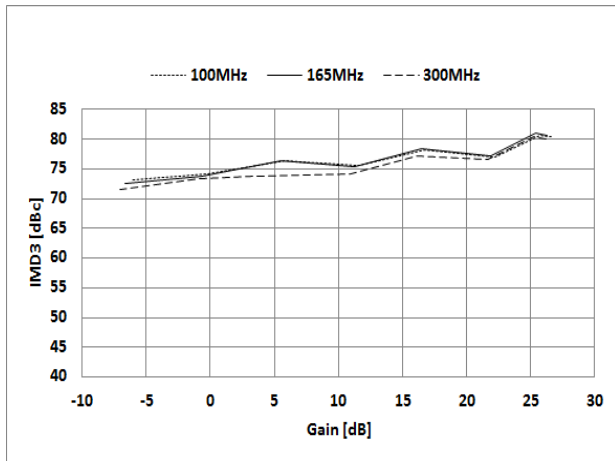

Figure.7-1 IMD3 VS Gain (Temp =25°C)

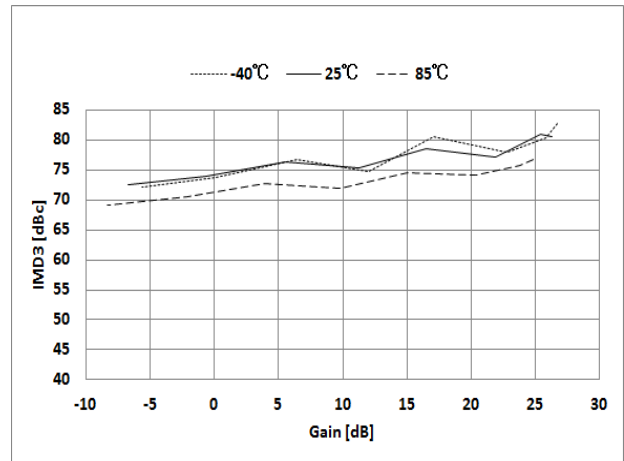
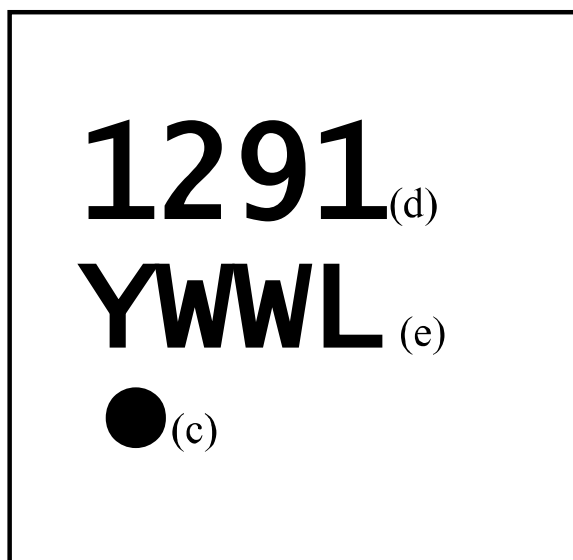

Figure.7-2 IMD3 VS Gain (fo=165MHz)

**14. Marking**

- (a) Style : QFN  
(b) Number of pins : 24  
(c) 1 pin marking: ○  
(d) Product number : 1291  
(e) Date code : YWWL (4 digits)
- Y: Lower 1 digit of calendar year (Year 2013 → 3, 2014 → 4 ...)  
WW: Week  
L: Lot identification, given to each product lot which is made in a week
- LOT ID is given in alphabetical order (A, B, C...).





## IMPORTANT NOTICE

0. Asahi Kasei Microdevices Corporation (“AKM”) reserves the right to make changes to the information contained in this document without notice. When you consider any use or application of AKM product stipulated in this document (“Product”), please make inquiries the sales office of AKM or authorized distributors as to current status of the Products.
1. All information included in this document are provided only to illustrate the operation and application examples of AKM Products. AKM neither makes warranties or representations with respect to the accuracy or completeness of the information contained in this document nor grants any license to any intellectual property rights or any other rights of AKM or any third party with respect to the information in this document. You are fully responsible for use of such information contained in this document in your product design or applications. **AKM ASSUMES NO LIABILITY FOR ANY LOSSES INCURRED BY YOU OR THIRD PARTIES ARISING FROM THE USE OF SUCH INFORMATION IN YOUR PRODUCT DESIGN OR APPLICATIONS.**
2. The Product is neither intended nor warranted for use in equipment or systems that require extraordinarily high levels of quality and/or reliability and/or a malfunction or failure of which may cause loss of human life, bodily injury, serious property damage or serious public impact, including but not limited to, equipment used in nuclear facilities, equipment used in the aerospace industry, medical equipment, equipment used for automobiles, trains, ships and other transportation, traffic signaling equipment, equipment used to control combustions or explosions, safety devices, elevators and escalators, devices related to electric power, and equipment used in finance-related fields. Do not use Product for the above use unless specifically agreed by AKM in writing.
3. Though AKM works continually to improve the Product’s quality and reliability, you are responsible for complying with safety standards and for providing adequate designs and safeguards for your hardware, software and systems which minimize risk and avoid situations in which a malfunction or failure of the Product could cause loss of human life, bodily injury or damage to property, including data loss or corruption.
4. Do not use or otherwise make available the Product or related technology or any information contained in this document for any military purposes, including without limitation, for the design, development, use, stockpiling or manufacturing of nuclear, chemical, or biological weapons or missile technology products (mass destruction weapons). When exporting the Products or related technology or any information contained in this document, you should comply with the applicable export control laws and regulations and follow the procedures required by such laws and regulations. The Products and related technology may not be used for or incorporated into any products or systems whose manufacture, use, or sale is prohibited under any applicable domestic or foreign laws or regulations.
5. Please contact AKM sales representative for details as to environmental matters such as the RoHS compatibility of the Product. Please use the Product in compliance with all applicable laws and regulations that regulate the inclusion or use of controlled substances, including without limitation, the EU RoHS Directive. AKM assumes no liability for damages or losses occurring as a result of noncompliance with applicable laws and regulations.
6. Resale of the Product with provisions different from the statement and/or technical features set forth in this document shall immediately void any warranty granted by AKM for the Product and shall not create or extend in any manner whatsoever, any liability of AKM.
7. This document may not be reproduced or duplicated, in any form, in whole or in part, without prior written consent of AKM.