

368511-1 ✓ ACTIVE

Multilock Connector System

TE Internal #: 368511-1

Wire-to-Wire, 20 Position, Natural, Signal, Cable Mount (Free-Hanging), Multilock Connector System

[View on TE.com >](#)



Connectors > Automotive Connectors > Automotive Housings > MULTILOCK, CONNECTOR HOUSING

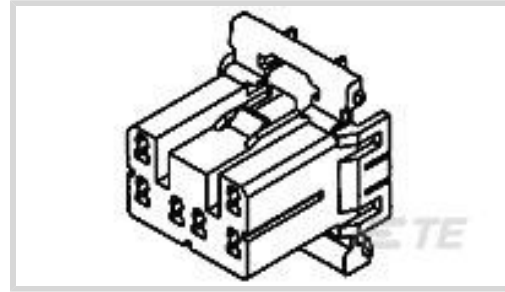

Mating Tab Width: 1.8 mm [.071 in]

Connector System: **Wire-to-Wire**

Number of Positions: 20

Sealable: **No**

Hybrid Connector: **No**

[All MULTILOCK, CONNECTOR HOUSING \(567\)](#)

Features

Product Type Features

Connector Shape	Rectangular
Connector System	Wire-to-Wire
Sealable	No
Hybrid Connector	No

Configuration Features

Number of Positions	20
Number of Rows	2

Body Features

Primary Product Color	Natural
-----------------------	---------

Contact Features

Contact Size	1.8mm
Mating Tab Width	1.8 mm[.071 in]

Mechanical Attachment

Terminal Position Assurance	No
Strain Relief	Without
Mating Alignment Type	Polarized
Mating Alignment	With



Connector Mounting Type	Cable Mount (Free-Hanging)
-------------------------	----------------------------

Housing Features

Housing Material	Polybutylene Terephthalate
------------------	----------------------------

Dimensions

Connector Height	21.6 mm[.85 in]
------------------	-----------------

Product Width	26 mm[1.024 in]
---------------	-----------------

Product Length	45.8 mm[1.803 in]
----------------	-------------------

Row-to-Row Spacing	5.9 mm[.232 in]
--------------------	-----------------

Operation/Application

Circuit Application	Signal
---------------------	--------

Packaging Features

Packaging Quantity	150
--------------------	-----

Packaging Method	Bag
------------------	-----

Other

Connector Position Assurance Capable	No
--------------------------------------	----

Product Compliance

[For compliance documentation, visit the product page on TE.com>](#)

EU RoHS Directive 2011/65/EU	Compliant
------------------------------	-----------

EU ELV Directive 2000/53/EC	Compliant
-----------------------------	-----------

China RoHS 2 Directive MIIT Order No 32, 2016	No Restricted Materials Above Threshold
---	---

EU REACH Regulation (EC) No. 1907/2006	Current ECHA Candidate List: JUNE 2023 (235) Candidate List Declared Against: JAN 2023 (233) Does not contain REACH SVHC
--	--

Halogen Content	Low Halogen - Br, Cl, F, I < 900 ppm per homogenous material. Also BFR/CFR/PVC Free
-----------------	---

Solder Process Capability	Not applicable for solder process capability
---------------------------	--

Product Compliance Disclaimer

This information is provided based on reasonable inquiry of our suppliers and represents our current actual knowledge based on the information they provided. This information is subject to change. The part numbers that TE has identified as EU RoHS compliant have a maximum concentration of 0.1% by weight in homogenous materials for lead, hexavalent chromium, mercury, PBB, PBDE, DBP, BBP, DEHP, DIBP, and 0.01% for cadmium, or qualify for an exemption to these limits as defined in the Annexes of Directive 2011/65/EU (RoHS2). Finished electrical and electronic equipment products will be CE marked as required by Directive 2011/65/EU. Components may not be CE marked. Additionally, the part

numbers that TE has identified as EU ELV compliant have a maximum concentration of 0.1% by weight in homogenous materials for lead, hexavalent chromium, and mercury, and 0.01% for cadmium, or qualify for an exemption to these limits as defined in the Annexes of Directive 2000/53/EC (ELV). Regarding the REACH Regulation, the information TE provides on SVHC in articles for this part number is based on the latest European Chemicals Agency (ECHA) 'Guidance on requirements for substances in articles' posted at this URL: <https://echa.europa.eu/guidance-documents/guidance-on-reach>

Compatible Parts



Also in the Series | Multilock Connector System

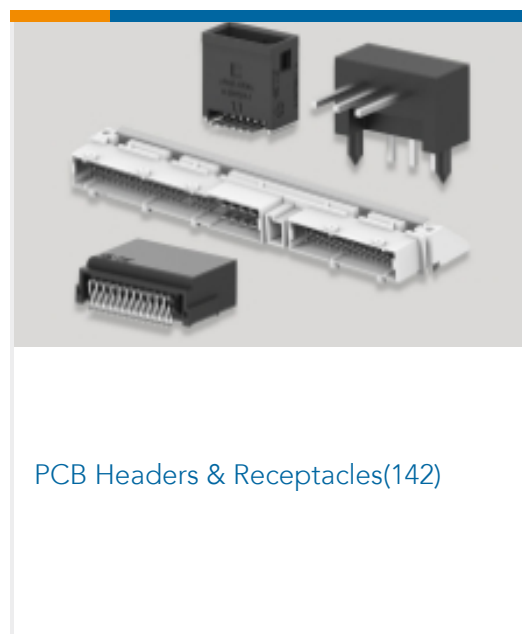
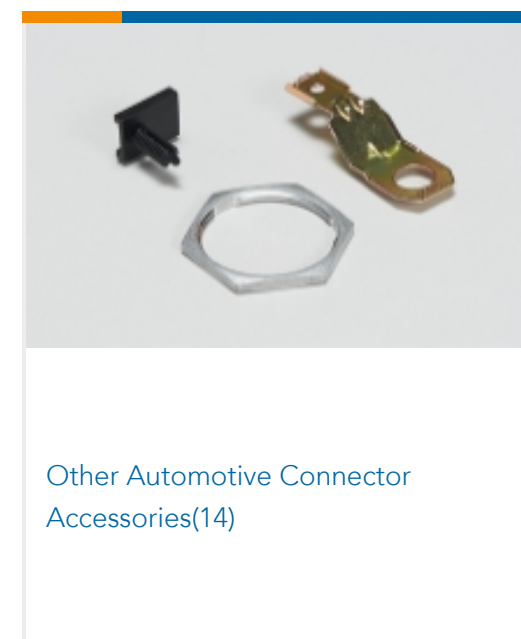
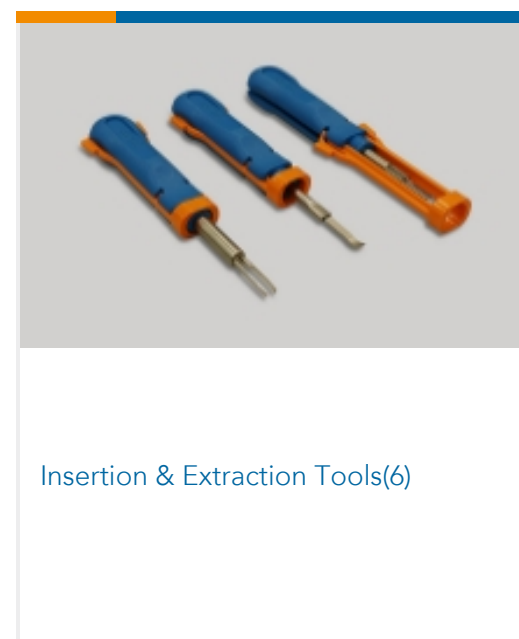
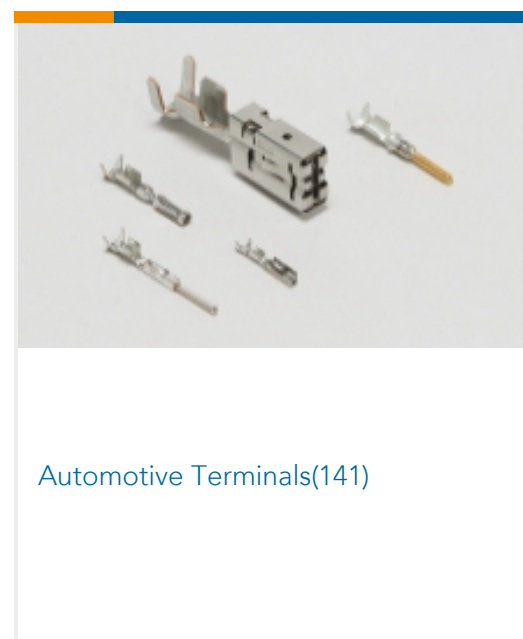
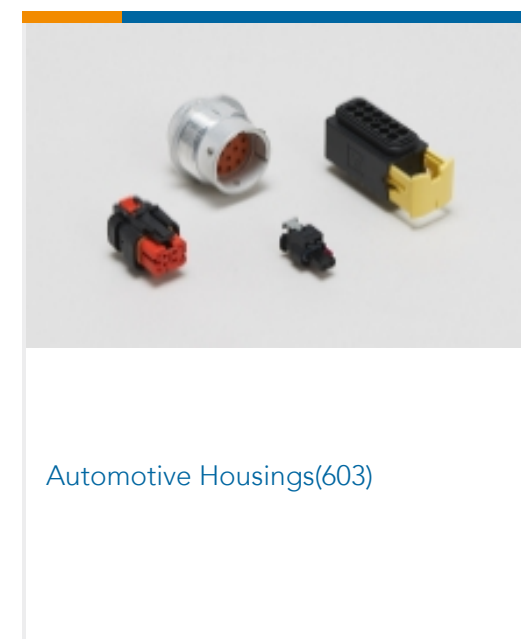
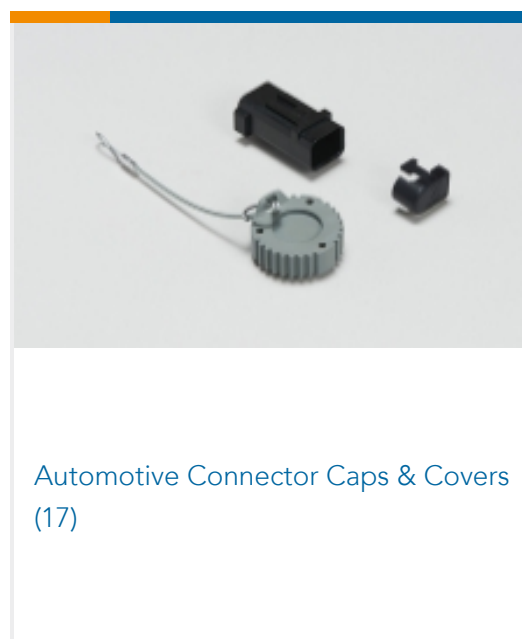

Customers Also Bought



TE Part #85202-1
Timer Connector Housing

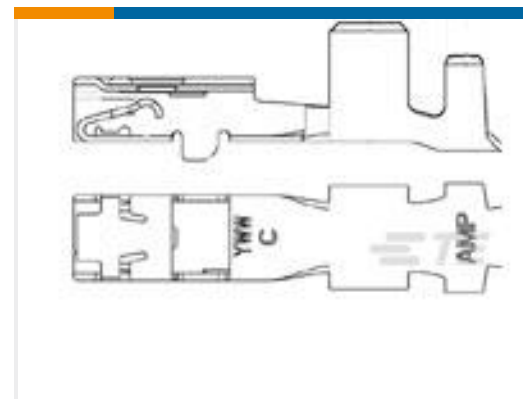

TE Part #1326030-5
2.8MM RECP, UNSEAL, 22AWG, REVREE



TE Part #936209-1
MULTILOCK, CONNECTOR HOUSING

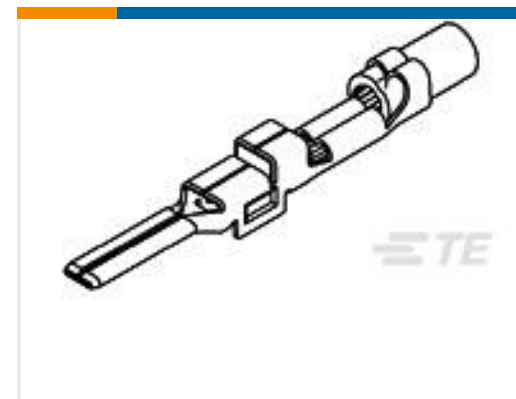

TE Part #368087-1
090II NON SLD TAB(SQ0.85-1.25)



TE Part #2209477-2
KIT ASS'Y FOR 52POS.MQS FEMALE
CONNECTOR



TE Part #1456968-8
CONTACT, FEMALE, 0.64, 0.35SQMM,
AG, DIR



TE Part #2005098-1
025 TAB CONTACT(SS)



TE Part #2272975-5
6 Pos. Sealed MCON 1.2 Connect

Documents

Product Drawings

[070 MLC PLUG 20P HSG](#)

CAD Files

Customer View Model

[ENG_CVM_CVM_368511-1_O.2d_dxf.zip](#)

English

3D PDF

3D

Customer View Model

[ENG_CVM_CVM_368511-1_O.3d_igs.zip](#)

English

Customer View Model

[ENG_CVM_CVM_368511-1_O.3d_stp.zip](#)

English

By downloading the CAD file I accept and agree to the [Terms and Conditions](#) of use.

Datasheets & Catalog Pages

[MULTILOCK Connector System](#)

English

Product Specifications

[070 MLC Series](#)

English