

Designer's™ Data Sheet

Insulated Gate Bipolar Transistor with Anti-Parallel Diode

N-Channel Enhancement-Mode Silicon Gate

MGW12N120D

Motorola Preferred Device

IGBT & DIODE IN TO-247
12 A @ 90°C
20 A @ 25°C
1200 VOLTS
SHORT CIRCUIT RATED

This Insulated Gate Bipolar Transistor (IGBT) is co-packaged with a soft recovery ultra-fast rectifier and uses an advanced termination scheme to provide an enhanced and reliable high voltage-blocking capability. Short circuit rated IGBT's are specifically suited for applications requiring a guaranteed short circuit withstand time such as Motor Control Drives. Fast switching characteristics result in efficient operation at high frequencies. Co-packaged IGBT's save space, reduce assembly time and cost.

- Industry Standard High Power TO-247 Package with Isolated Mounting Hole
- High Speed E_{off} : 150 μ J/A typical at 125°C
- High Short Circuit Capability – 10 μ s minimum
- Soft Recovery Free Wheeling Diode is included in the package
- Robust High Voltage Termination
- Robust RBSOA

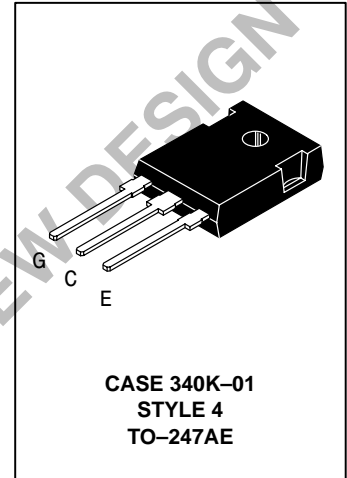
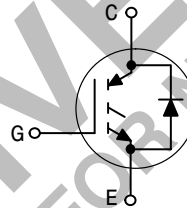

MAXIMUM RATINGS ($T_J = 25^\circ\text{C}$ unless otherwise noted)

Rating	Symbol	Value	Unit
Collector-Emitter Voltage	V_{CES}	1200	Vdc
Collector-Gate Voltage ($R_{GE} = 1.0 \text{ M}\Omega$)	V_{CGR}	1200	Vdc
Gate-Emitter Voltage — Continuous	V_{GE}	± 20	Vdc
Collector Current — Continuous @ $T_C = 25^\circ\text{C}$ — Continuous @ $T_C = 90^\circ\text{C}$ — Repetitive Pulsed Current (1)	I_{C25} I_{C90} I_{CM}	20 12 40	Adc Apc
Total Power Dissipation @ $T_C = 25^\circ\text{C}$ Derate above 25°C	P_D	125 0.98	Watts W/°C
Operating and Storage Junction Temperature Range	T_J, T_{stg}	-55 to 150	°C
Short Circuit Withstand Time ($V_{CC} = 720 \text{ Vdc}$, $V_{GE} = 15 \text{ Vdc}$, $T_J = 125^\circ\text{C}$, $R_G = 20 \Omega$)	t_{sc}	10	μ s
Thermal Resistance — Junction to Case – IGBT — Junction to Case – Diode — Junction to Ambient	$R_{\theta JC}$ $R_{\theta JC}$ $R_{\theta JA}$	1.0 1.4 45	°C/W
Maximum Lead Temperature for Soldering Purposes, 1/8" from case for 5 seconds	T_L	260	°C
Mounting Torque, 6-32 or M3 screw		10 lbf•in (1.13 N•m)	

(1) Pulse width is limited by maximum junction temperature. Repetitive rating.

Designer's Data for "Worst Case" Conditions — The Designer's Data Sheet permits the design of most circuits entirely from the information presented. SOA Limit curves — representing boundaries on device characteristics — are given to facilitate "worst case" design.

Designer's is a trademark of Motorola, Inc.

Preferred devices are Motorola recommended choices for future use and best overall value.

REV 3

MGW12N120D

ELECTRICAL CHARACTERISTICS (T_J = 25°C unless otherwise noted)

Characteristic	Symbol	Min	Typ	Max	Unit
OFF CHARACTERISTICS					
Collector-to-Emitter Breakdown Voltage (V _{GE} = 0 Vdc, I _C = 25 μAdc) Temperature Coefficient (Positive)	V _{(BR)CES}	1200 —	— 870	— —	Vdc mV/°C
Zero Gate Voltage Collector Current (V _{CE} = 1200 Vdc, V _{GE} = 0 Vdc) (V _{CE} = 1200 Vdc, V _{GE} = 0 Vdc, T _J = 125°C)	I _{CES}	— —	— —	100 2500	μAdc
Gate-Body Leakage Current (V _{GE} = ± 20 Vdc, V _{CE} = 0 Vdc)	I _{GES}	—	—	250	nAdc

ON CHARACTERISTICS (1)

Collector-to-Emitter On-State Voltage (V _{GE} = 15 Vdc, I _C = 5.0 Adc) (V _{GE} = 15 Vdc, I _C = 5.0 Adc, T _J = 125°C) (V _{GE} = 15 Vdc, I _C = 10 Adc)	V _{CE(on)}	— — —	2.71 3.78 3.5	3.37 — 4.42	Vdc
Gate Threshold Voltage (V _{CE} = V _{GE} , I _C = 1.0 mAdc) Threshold Temperature Coefficient (Negative)	V _{GE(th)}	4.0 —	6.0 10	8.0 —	Vdc mV/°C
Forward Transconductance (V _{CE} = 10 Vdc, I _C = 10 Adc)	g _{fe}	—	12	—	Mhos

DYNAMIC CHARACTERISTICS

Input Capacitance	(V _{CE} = 25 Vdc, V _{GE} = 0 Vdc, f = 1.0 MHz)	C _{ies}	—	1003	—	pF
Output Capacitance		C _{oes}	—	126	—	
Transfer Capacitance		C _{res}	—	106	—	

SWITCHING CHARACTERISTICS (1)

Turn-On Delay Time	(V _{CC} = 720 Vdc, I _C = 10 Adc, V _{GE} = 15 Vdc, L = 300 μH R _G = 20 Ω) Energy losses include "tail"	t _{d(on)}	—	74	—	ns
Rise Time		t _r	—	83	—	
Turn-Off Delay Time		t _{d(off)}	—	76	—	
Fall Time		t _f	—	231	—	mJ
Turn-Off Switching Loss		E _{off}	—	0.55	1.33	
Turn-On Switching Loss		E _{on}	—	1.21	1.88	
Total Switching Loss		E _{ts}	—	1.76	3.21	
Turn-On Delay Time	(V _{CC} = 720 Vdc, I _C = 10 Adc, V _{GE} = 15 Vdc, L = 300 μH R _G = 20 Ω, T _J = 125°C) Energy losses include "tail"	t _{d(on)}	—	66	—	ns
Rise Time		t _r	—	87	—	
Turn-Off Delay Time		t _{d(off)}	—	120	—	
Fall Time		t _f	—	575	—	mJ
Turn-Off Switching Loss		E _{off}	—	1.49	—	
Turn-On Switching Loss		E _{on}	—	2.37	—	
Total Switching Loss		E _{ts}	—	3.86	—	
Gate Charge	(V _{CC} = 720 Vdc, I _C = 10 Adc, V _{GE} = 15 Vdc)	Q _T	—	29	—	nC
		Q ₁	—	13	—	
		Q ₂	—	12	—	

DIODE CHARACTERISTICS

Diode Forward Voltage Drop (I _{EC} = 5.0 Adc) (I _{EC} = 5.0 Adc, T _J = 125°C) (I _{EC} = 10 Adc)	V _{FEC}	— — —	2.26 1.37 2.86	3.32 — 4.18	Vdc
--	------------------	-------------	----------------------	-------------------	-----

(1) Pulse Test: Pulse Width ≤ 300 μs, Duty Cycle ≤ 2%.

(continued)

ELECTRICAL CHARACTERISTICS — continued ($T_J = 25^\circ\text{C}$ unless otherwise noted)

Characteristic	Symbol	Min	Typ	Max	Unit	
DIODE CHARACTERISTICS — continued						
Reverse Recovery Time	$(I_F = 10 \text{ Adc}, V_R = 720 \text{ Vdc}, \text{d}I_F/\text{d}t = 100 \text{ A}/\mu\text{s})$	t_{rr}	—	116	—	ns
		t_a	—	69	—	
		t_b	—	47	—	
Reverse Recovery Stored Charge	Q_{RR}	—	0.36	—	μC	
Reverse Recovery Time	$(I_F = 10 \text{ Adc}, V_R = 720 \text{ Vdc}, \text{d}I_F/\text{d}t = 100 \text{ A}/\mu\text{s}, T_J = 125^\circ\text{C})$	t_{rr}	—	234	—	ns
		t_a	—	149	—	
		t_b	—	85	—	
Reverse Recovery Stored Charge	Q_{RR}	—	1.40	—	μC	
INTERNAL PACKAGE INDUCTANCE						
Internal Emitter Inductance (Measured from the emitter lead 0.25" from package to emitter bond pad)	L_E	—	13	—	nH	

TYPICAL ELECTRICAL CHARACTERISTICS

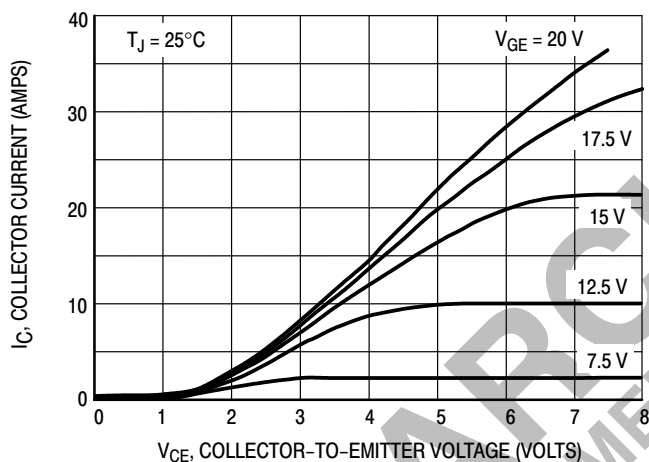

Figure 1. Output Characteristics

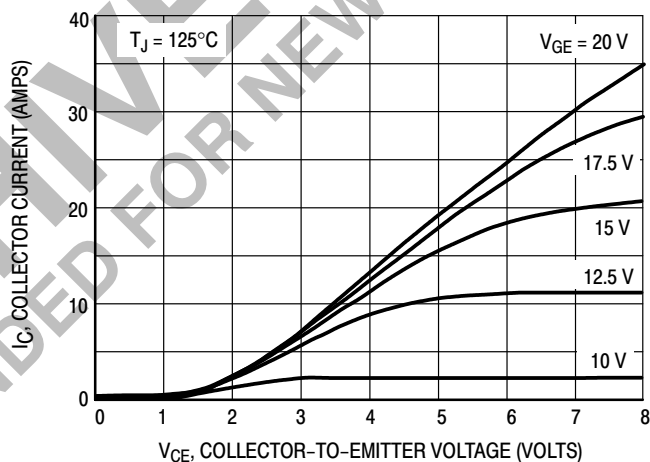

Figure 2. Output Characteristics

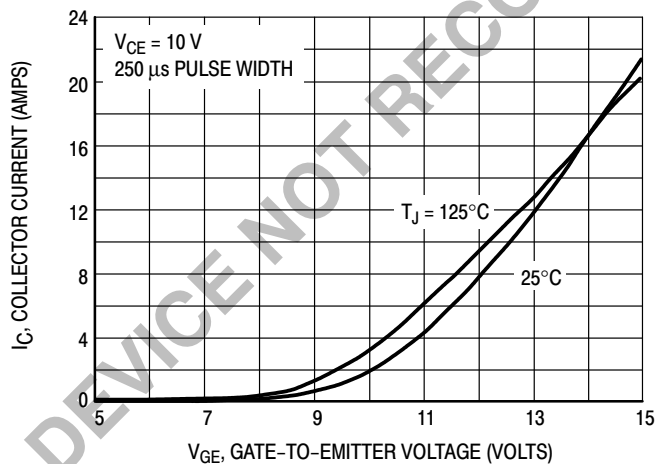

Figure 3. Transfer Characteristics

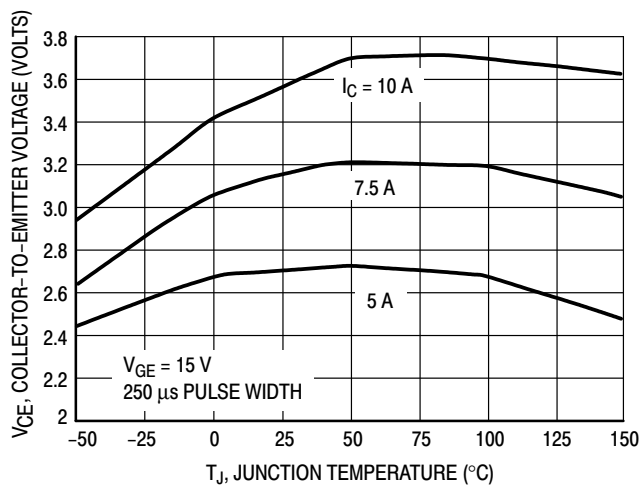

Figure 4. Collector-to-Emitter Saturation Voltage versus Junction Temperature

MGW12N120D

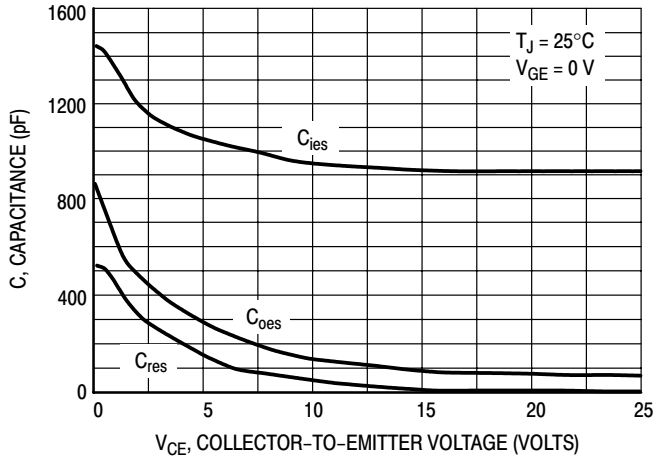

Figure 5. Capacitance Variation

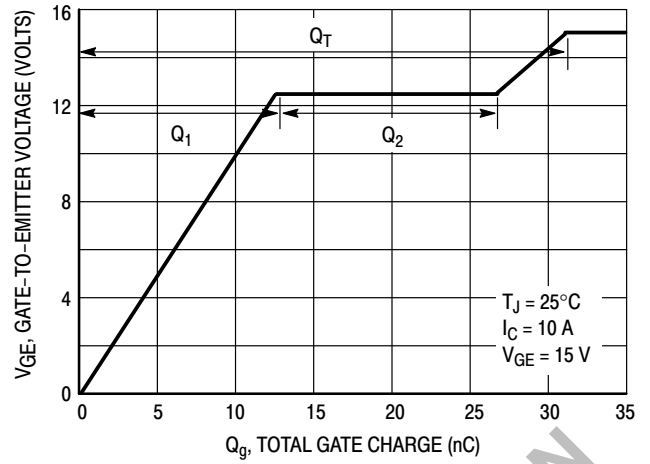

Figure 6. Gate-to-Emitter Voltage versus Total Charge

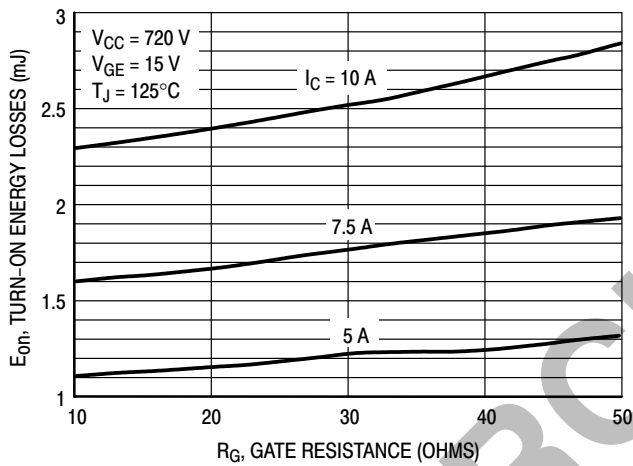

Figure 7. Turn-On Losses versus Gate Resistance

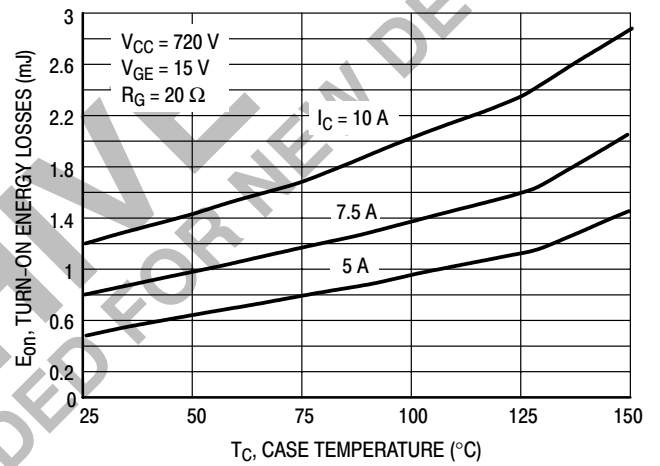

Figure 8. Turn-On Losses versus Case Temperature

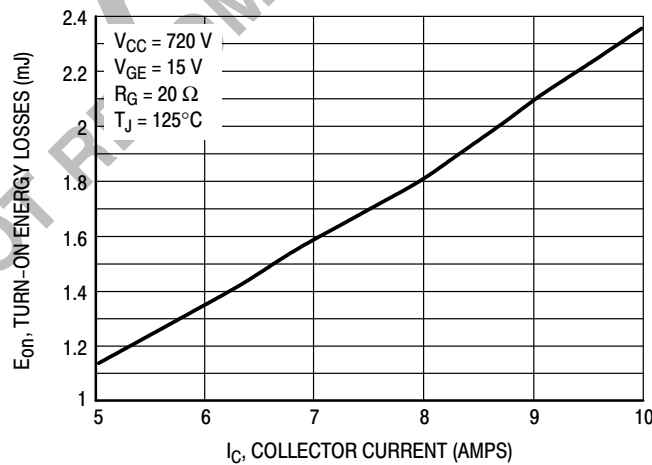

Figure 9. Turn-On Losses versus Collector Current

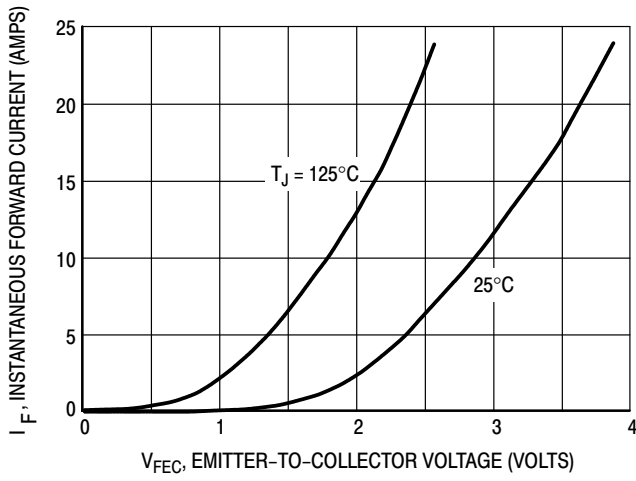

Figure 10. Diode Forward Voltage Drop

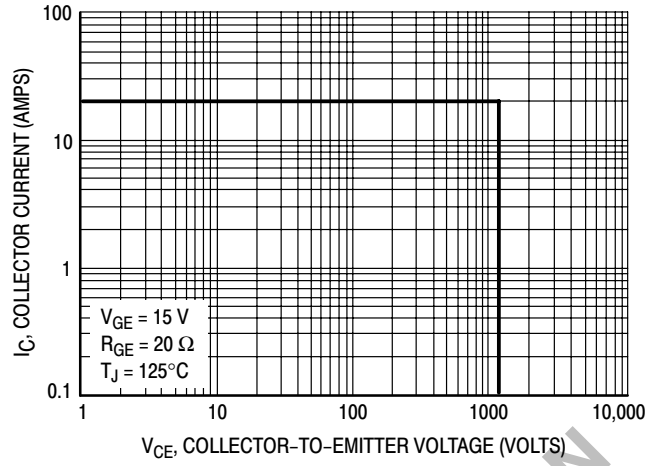

Figure 11. Reverse Biased Safe Operating Area

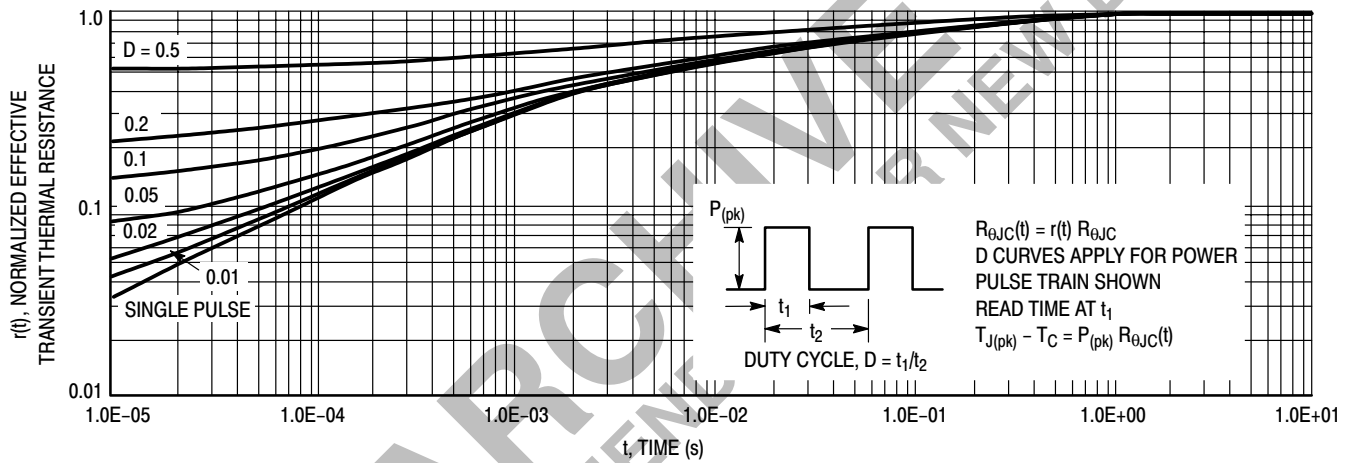
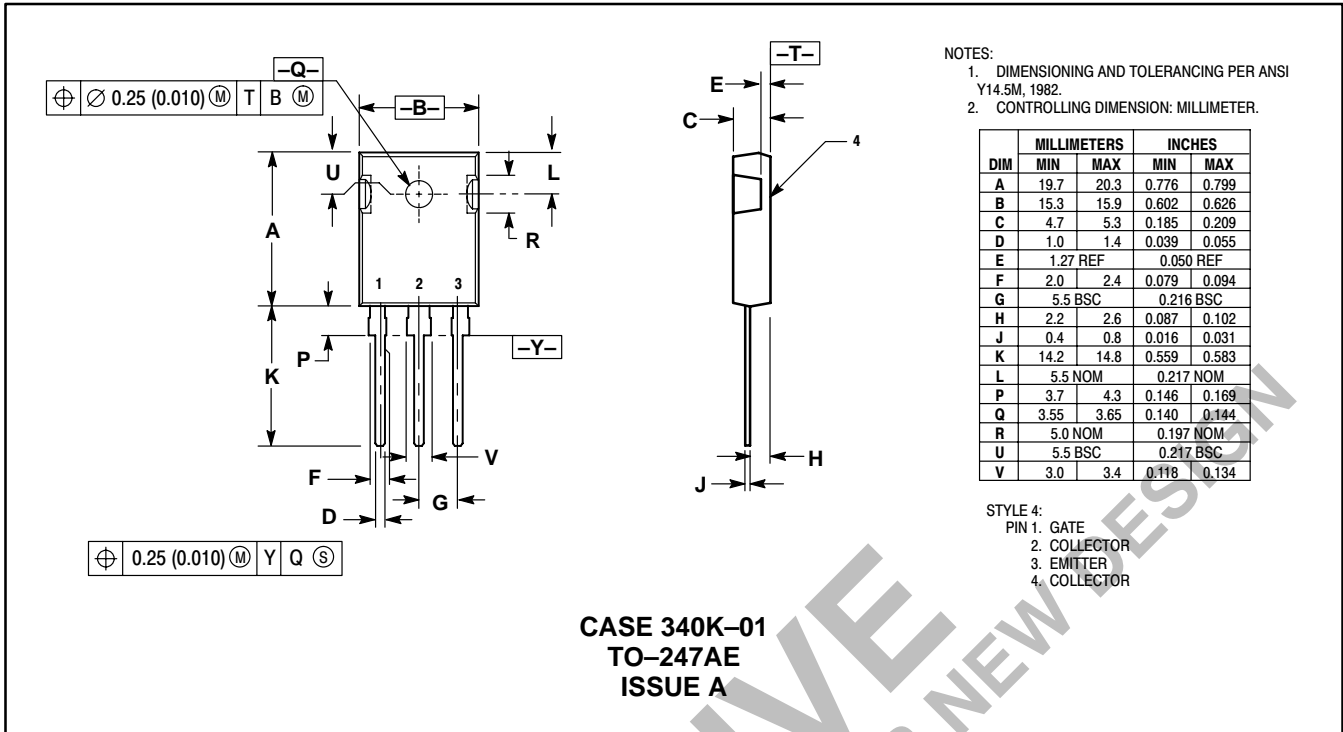

Figure 12. Thermal Response

PACKAGE DIMENSIONS



Motorola reserves the right to make changes without further notice to any products herein. Motorola makes no warranty, representation or guarantee regarding the suitability of its products for any particular purpose, nor does Motorola assume any liability arising out of the application or use of any product or circuit, and specifically disclaims any and all liability, including without limitation consequential or incidental damages. "Typical" parameters which may be provided in Motorola data sheets and/or specifications can and do vary in different applications and actual performance may vary over time. All operating parameters, including "Typicals" must be validated for each customer application by customer's technical experts. Motorola does not convey any license under its patent rights nor the rights of others. Motorola products are not designed, intended, or authorized for use as components in systems intended for surgical implant into the body, or other applications intended to support or sustain life, or for any other application in which the failure of the Motorola product could create a situation where personal injury or death may occur. Should Buyer purchase or use Motorola products for any such unintended or unauthorized application, Buyer shall indemnify and hold Motorola and its officers, employees, subsidiaries, affiliates, and distributors harmless against all claims, costs, damages, and expenses, and reasonable attorney fees arising out of, directly or indirectly, any claim of personal injury or death associated with such unintended or unauthorized use, even if such claim alleges that Motorola was negligent regarding the design or manufacture of the part. Motorola and are registered trademarks of Motorola, Inc. Motorola, Inc. is an Equal Opportunity/Affirmative Action Employer.

Mfax is a trademark of Motorola, Inc.

How to reach us:

USA/EUROPE/Locations Not Listed: Motorola Literature Distribution;
 P.O. Box 5405, Denver, Colorado 80217. 1-303-675-2140 or 1-800-441-2447

JAPAN: Nippon Motorola Ltd.: SPD, Strategic Planning Office, 141,
 4-32-1 Nishi-Gotanda, Shagawa-ku, Tokyo, Japan. 03-5487-8488

Customer Focus Center: 1-800-521-6274

Mfax™: RMFAX0@email.sps.mot.com – TOUCHTONE 1-602-244-6609
 Motorola Fax Back System – US & Canada ONLY 1-800-774-1848
 – http://sps.motorola.com/mfax/

ASIA/PACIFIC: Motorola Semiconductors H.K. Ltd.; 8B Tai Ping Industrial Park,
 51 Ting Kok Road, Tai Po, N.T., Hong Kong. 852-26629298

HOME PAGE: <http://motorola.com/sps/>

