

CUTE-3-M

~25° medium beam with 1.5 mm high location pins

SPECIFICATION:

Dimensions	Ø 35.0 mm
Height	15 mm
Fastening	glue, pin
ROHS compliant	yes ⓘ



MATERIALS:

Component	Type	Material	Colour	Finish
CUTE-3-M	Multi-lens	PMMA	clear	

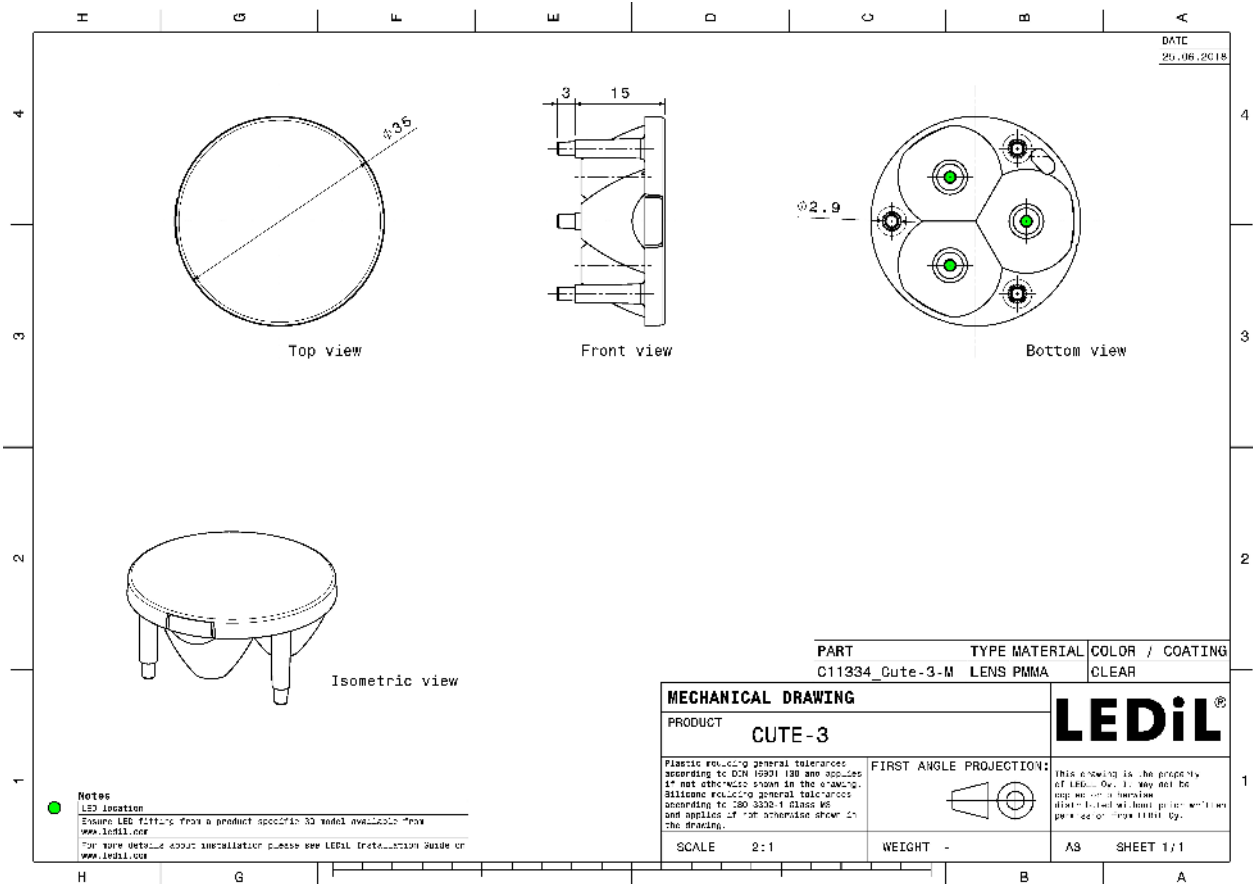

ORDERING INFORMATION:

Component	Qty in box	MOQ	MPQ	Box weight (kg)
C11334_CUTE-3-M » Box size: 480 x 280 x 300 mm	630	90	45	6.8

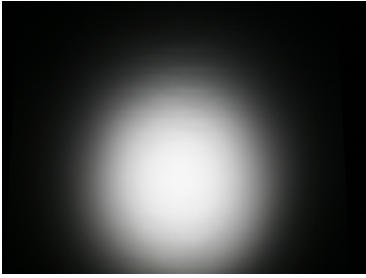
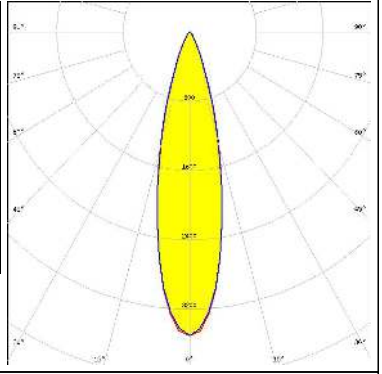

See also our general installation guide: www.ledil.com/installation_guide

OPTICAL RESULTS (MEASURED):

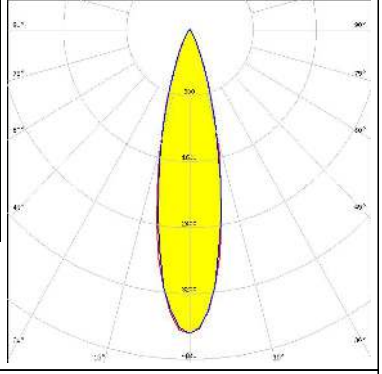
<p>CREE ⇄ LED</p> <p>LED XM-L FWHM / FWTM 25.0° Efficiency 90 % LEDs/each optic 1 Light colour White Required components:</p>		
<p>CREE ⇄ LED</p> <p>LED XM-L2 FWHM / FWTM 26.0° / 49.0° Efficiency 89 % Peak intensity 3.7 cd/lm LEDs/each optic 1 Light colour White Required components:</p>		
<p>CREE ⇄ LED</p> <p>LED XP-E FWHM / FWTM 22.0° Efficiency 91 % LEDs/each optic 1 Light colour White Required components:</p>		
<p>CREE ⇄ LED</p> <p>LED XP-G FWHM / FWTM 24.0° Efficiency 91 % LEDs/each optic 1 Light colour White Required components:</p>		

OPTICAL RESULTS (MEASURED):



LED XP-L HD
FWHM / FWTM 24.0° / 48.0°
Efficiency 88 %
Peak intensity 3.9 cd/lm
LEDs/each optic 1
Light colour White
Required components:



LED LUXEON A
FWHM / FWTM 24.0°
Efficiency %
LEDs/each optic 1
Light colour White
Required components:





LED LUXEON Rebel
FWHM / FWTM 22.0°
Efficiency 91 %
LEDs/each optic 1
Light colour White
Required components:

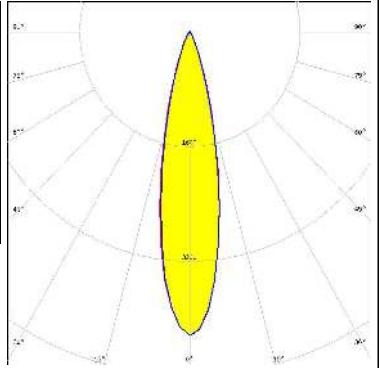

LED LUXEON Rebel ES
FWHM / FWTM 24.0°
Efficiency 92 %
LEDs/each optic 1
Light colour White
Required components:

OPTICAL RESULTS (MEASURED):

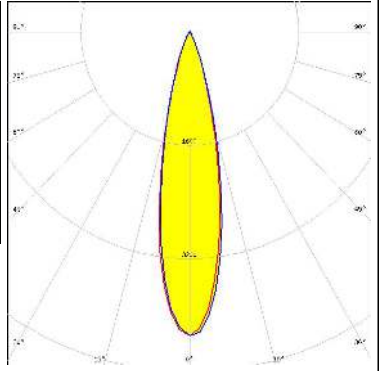
<p>LUMILEDS</p> <p>LED LUXEON T</p> <p>FWHM / FWTM 23.0° / 43.0°</p> <p>Efficiency 89 %</p> <p>Peak intensity 4.2 cd/lm</p> <p>LEDs/each optic 1</p> <p>Light colour White</p> <p>Required components:</p>		
<p>LUMILEDS</p> <p>LED LUXEON TX</p> <p>FWHM / FWTM 25.0° / 44.0°</p> <p>Efficiency 88 %</p> <p>Peak intensity 4.3 cd/lm</p> <p>LEDs/each optic 1</p> <p>Light colour White</p> <p>Required components:</p>		
<p>NICHIA</p> <p>LED NCSxx19A</p> <p>FWHM / FWTM 25.0°</p> <p>Efficiency 88 %</p> <p>LEDs/each optic 1</p> <p>Light colour White</p> <p>Required components:</p>		
<p>NICHIA</p> <p>LED NVSxx19A</p> <p>FWHM / FWTM 25.0°</p> <p>Efficiency 88 %</p> <p>LEDs/each optic 1</p> <p>Light colour White</p> <p>Required components:</p>		

OPTICAL RESULTS (MEASURED):

OSRAM Opto Semiconductors	
LED	OSLON SSL 80
FWHM / FWTM	22.0°
Efficiency	89 %
LEDs/each optic	1
Light colour	White
Required components:	
TOSHIBA Leading Innovation >>>	
LED	TL1L3
FWHM / FWTM	26.0° / 51.0°
Efficiency	86 %
Peak intensity	2.6 cd/lm
LEDs/each optic	1
Light colour	White
Required components:	

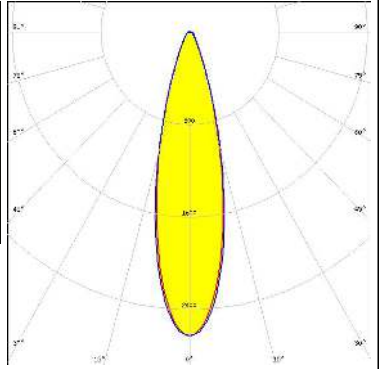
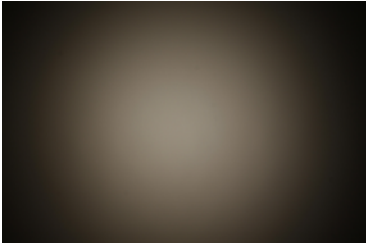

OPTICAL RESULTS (SIMULATED):



LED XM-L HVW
FWHM / FWTM 33.0°
Efficiency %
LEDs/each optic 1
Light colour White
Required components:



LED XT-E HVW
FWHM / FWTM 30.0°
Efficiency %
LEDs/each optic 1
Light colour White
Required components:



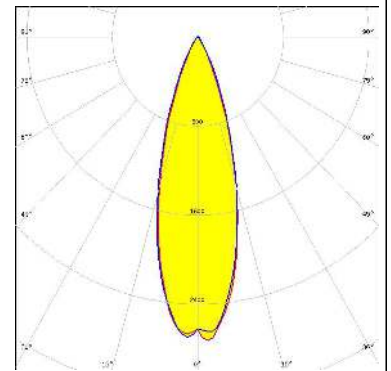

LED LUXEON H50-2
FWHM / FWTM 30.0° / 54.0°
Efficiency 90 %
Peak intensity 2.7 cd/lm
LEDs/each optic 1
Light colour White
Required components:

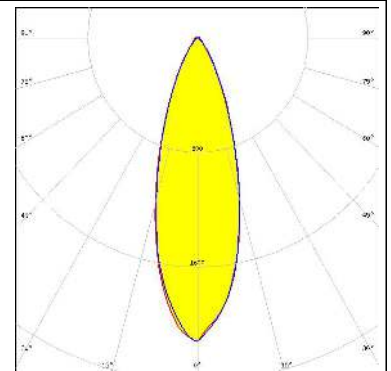

LED SST-70X-WCS
FWHM / FWTM 32.0° / 64.0°
Efficiency 93 %
Peak intensity 2.1 cd/lm
LEDs/each optic 1
Light colour White
Required components:

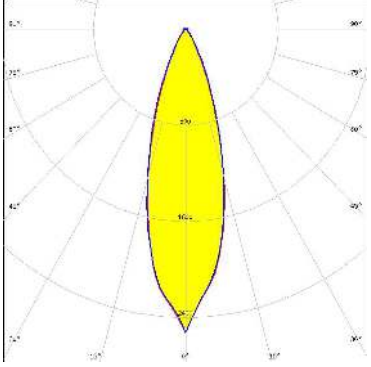

OPTICAL RESULTS (SIMULATED):

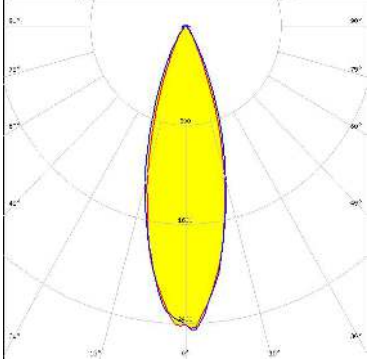
 LED NVSxx19B/NVSxx19C FWHM / FWTM 30.0° / 57.0° Efficiency 89 % Peak intensity 2.5 cd/lm LEDs/each optic 1 Light colour White Required components:	
 LED OSLOM SSL 150 FWHM / FWTM 30.0° / 54.0° Efficiency 94 % Peak intensity 2.9 cd/lm LEDs/each optic 1 Light colour White Required components:	
 LED Z5M1/Z5M2 FWHM / FWTM 31.0° / 57.0° Efficiency 91 % LEDs/each optic 1 Light colour White Required components:	

GENERAL INFORMATION:

NOTE: The typical beam angle will be changed by different color, chip size and chip position tolerance. The typical total beam angle is the full angle measured where the luminous intensity is half of the peak value.

MATERIALS:

As part of our continuous research and improvement processes, and to ensure the best possible quality and availability of our products, LEDiL reserves the right to change material grades without notice.

PRODUCT DATA USER AGREEMENT AND DISCLAIMER:

The measured data in the provided downloadable LEDiL Product Datasheets and Mechanical 2D-Drawings is rounded and provided as reference for planning. LEDiL Oy's optical specifications have been verified by conducting performance testing of the products in accordance with the company's quality system. The reported data are averaged results of multiple measurements with typical variation. LEDiL Oy reserves the right to without prior notification make changes and improvements to its products.

LEDiL Oy assumes neither warranty, nor guarantee nor any other liability of any kind for the contents and correctness of the provided data. The provided data has been generated with highest diligence but the provided data may in reality not represent the complete possible variation range of all intrinsic parameters. Therefore, in certain cases a deviation from the provided data could occur.

LEDiL Oy reserves the right to undertake technical changes of its products without further notification which could lead to changes in the provided data. LEDiL Oy assumes no liability of any kind for the possible deviation from any provided data or any other damage resulting from the usage of the provided data.

The user agrees to this disclaimer and user agreement with the download or usage of the provided files.

LEDiL Oy

Joensuunkatu 13
FI-24240 SALO
Finland

LEDiL Inc.

228 West Page Street
Suite D
Sycamore IL 60178
USA

Ledil Optics Technology (Shenzhen) Co., Ltd.

405 , Block B
Casic Motor Building
Shenzhen 518057
P.R.CHINA

Local sales and technical support

[www.ledil.com/
where_to_buy](http://www.ledil.com/where_to_buy)

Shipping locations

Salo, Finland
Hong Kong, China

Distribution Partners

[www.ledil.com/
where_to_buy](http://www.ledil.com/where_to_buy)