

Description

Single pole thermal-magnetic circuit breaker with tease-free, trip-free, press-to-reset, snap action mechanism and additional manual release (M-type TM CBE to EN 60934). Designed for plug-in mounting with E-T-A sockets 10 and 16. Approved to CBE standard EN 60934 (IEC 60934).

Typical applications

Control equipment, extra-low voltage wiring systems and components.

Ordering information

Type No.

3200 plug-in

Current ratings

0.05...25 A

3200 - 5 A ordering example

Please be informed that we have minimum ordering quantities to be observed.

Standard current ratings and typical internal resistances

Current rating (A)	Internal resistance (Ω)	Current rating (A)	Internal resistance (Ω)
0.05	534	4	0.141
0.1	149	5	0.107
0.2	56	6	0.060
0.3	24.2	7	0.049
0.4	13.6	8	< 0.02
0.5	8.1	10	< 0.02
0.6	5.25	12	< 0.02
0.8	3.55	14	< 0.02
1	2.02	15	< 0.02
1.5	0.90	16	< 0.02
2	0.51	18	< 0.02
2.5	0.36	20	< 0.02
3	0.23	25	< 0.02

Approvals

Authority	Standard	Rated voltage	Current ratings
VDE	IEC/EN 60934	AC 240 V DC 28 V	0.05...25 A 0.05...25 A



3200-...

Technical data

For further details please see: http://www.e-t-a.de/ti_e

Voltage rating	AC 240 V, 50/60 Hz; DC 28 V	
Current ratings	0.05...25 A	
Typical life	500 operations at 1 x I _N , inductive 4,000 operations at 1 x I _N , resistive	
Ambient temperature	-30...+60 °C (-22...+140 °F)	
Insulation co-ordination (IEC 60664 and 60664 A)	rated impulse withstand voltage 2.5 kV reinforced insulation in operating area	pollution degree 2
Dielectric strength (IEC 60664 and 60664 A) operating area	test voltage AC 3,000 V double insulation	
Insulation resistance	> 100 MΩ (DC 500 V)	
Interrupting capacity I _{cn}	0.05...0.8 A 1...2 A 2.5...25 A	self-limiting 200 A 400 A
Degree of protection (IEC 60529/DIN 40050)	operating area IP40 terminal area IP00	
Vibration	5 g (57-500 Hz), ± 0.38 mm (10-57 Hz) to IEC 60068-2-6, test Fc 10 frequency cycles/axis	
Shock	25 g (11 ms) to IEC 60068-2-27, test Ea	
Corrosion	96 hours at 5 % salt mist to IEC 60068-2-11, test Ka	
Humidity	240 hours at 95 % RH to IEC 60068-2-78, test Cab	
Mass	approx. 50 g	

Dimensions

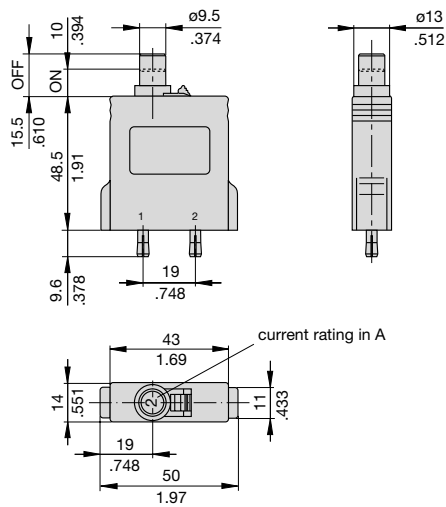

Internal connection diagram

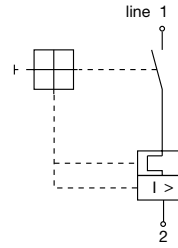

Installation drawing

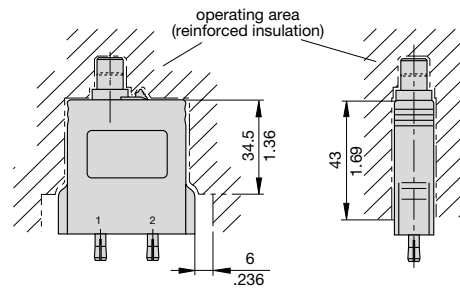

Typical time/current characteristics

0.05...7 A

AC/DC ¹⁾

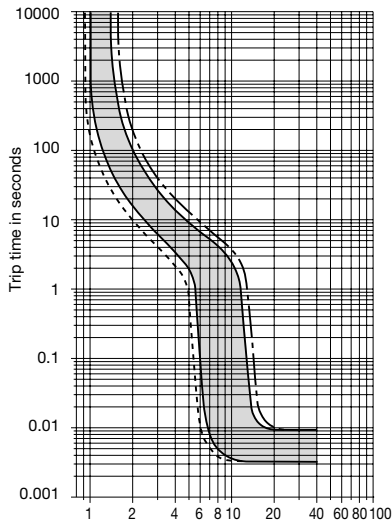

8...16 A

AC/DC ¹⁾

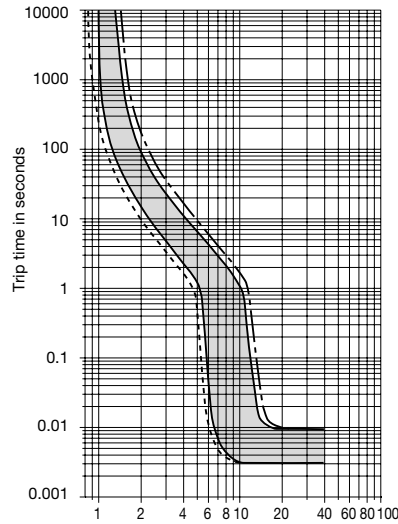

18...25 A

AC/DC ¹⁾

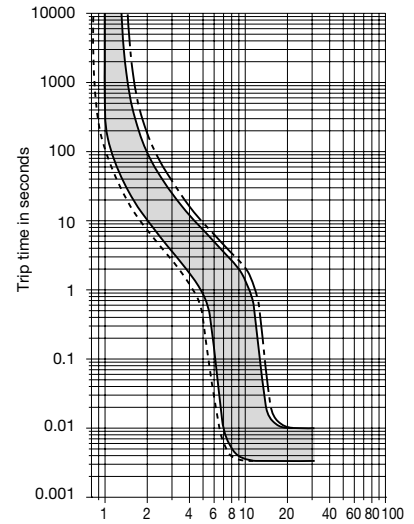

--- +60 °C
+140 °F ——— +23 °C
+73.4 °F - - - -30 °C
-22 °F

¹⁾Magnetic tripping currents are increased by 20 % on DC supplies.

Ambient temp. °F	-22	-4	+14	+32	+73.4	+86	+104	+122	+140
°C	-30	-20	-10	0	+23	+30	+40	+50	+60
Derating factor	0.76	0.79	0.83	0.88	1	1.04	1.11	1.19	1.29

The time/current characteristic curve depends on the ambient temperature prevailing. In order to eliminate nuisance tripping, please multiply the circuit breaker current ratings by the derating factor shown below. See also section Technical information.

This is a metric design and millimeter dimensions take precedence ($\frac{\text{mm}}{\text{inch}}$)

Accessories

Sockets 10R-K10

wire cross sectional areas
 2 x max. 2.5 mm² (AWG 14) stranded
 2 x max. 4 mm² (AWG 12) solid
 max. tightening torque of terminal screw: 1.2 Nm

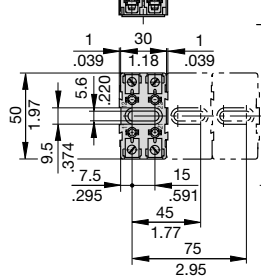

10R-P10

max. tightening torque of mounting screw: 2.5 Nm

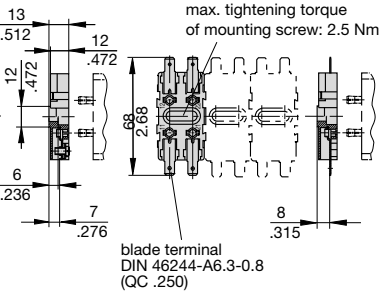

10R-A10

blade terminal
 DIN 46244-A6.3-0.8
 (QC .250)

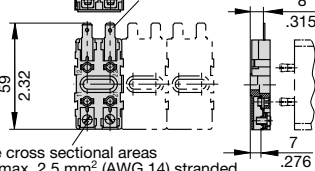

wire cross sectional areas
 2 x max. 2.5 mm² (AWG 14) stranded
 2 x max. 4 mm² (AWG 12) solid

Bus bars for sockets 10... (up to 20 A max. load)
Y 301 166 02, 2-way **Y 301 166 01, 4-way**

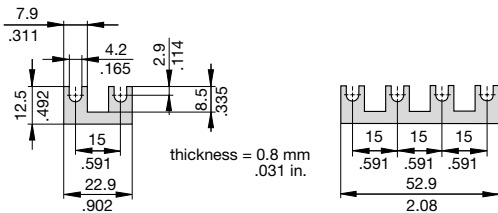

Socket 16

(up to 16 A max. load)

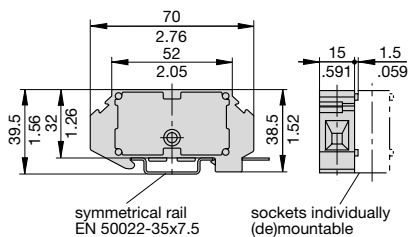

Adapter for socket 16
X 200 409 01
 for track mounting to EN 50035-G32 (G profile) on request

symmetrical rail EN 50022-35x7.5 sockets individually (de)mountable

Blanking plug
Y 301 477 01

for sockets 10R-P10/K10/A10

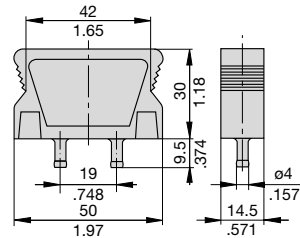

Terminal for mounting rack
 (DIN/EN 50 035-G32)

X 200 800 01
 for sockets 10R

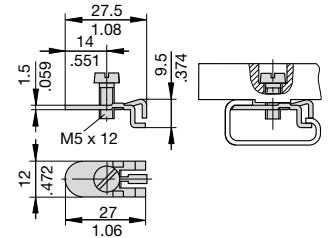

Connector bus links -K10

X 210 589 01/ 2.5 mm², (AWG 14) (black) up to 20 A max. load
X 210 589 02/ 1.5 mm², (AWG 16) (brown) up to 13 A max. load
 for sockets 10R-P10, 10R-A10 and 16

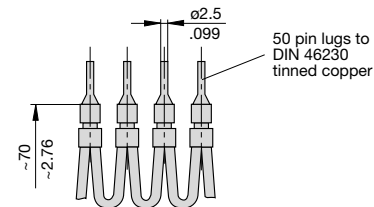

Connector bus links -P10

X 210 588 01/ 1.5 mm², (AWG 16) (brown) up to 13 A max. load
X 210 588 02/ 2.5 mm², (AWG 14) (black) up to 20 A max. load
X 210 588 03/ 2.5 mm², (AWG 14) (red) up to 20 A max. load
X 210 588 04/ 2.5 mm², (AWG 14) (blue) up to 20 A max. load
 for sockets 10R-P10, 10R-A10

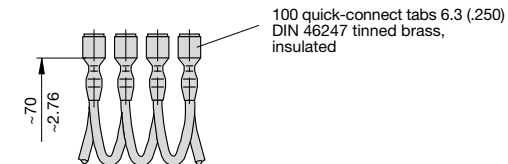

This is a metric design and millimeter dimensions take precedence ($\frac{\text{mm}}{\text{inch}}$)

All dimensions without tolerances are for reference only. In the interest of improved design, performance and cost effectiveness the right to make changes in these specifications without notice is reserved. Product markings may not be exactly as the ordering codes. Errors and omissions excepted.



