



SMHC2511 Series



1. Features of SMHC2511 series:

- 7.40 x 6.80mm foot Print , 3.00mm Max. height SMD Power Inductor for high frequency application. Operating frequency up to 5MHz.
- Inductance range from 0.10uH to 10.0uH. Custom values are welcomed.
- High saturation current characteristics by distributed gapped metal dust core.
- Ideal for portable device, Pad, E-reader and high density DC to DC Converter.
- Lower DC resistance for higher current application.
- Tape & Reel Quantity: 1000 piece per 13 inches reel. RoHS and HF compliant.

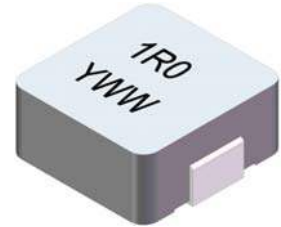

2. Electrical Characteristics of SMHC2511 series:

ITG Part Number	OCL (uH) ±20%	DCR (mΩ) Typ. @25°C	DCR (mΩ) Max. @25°C	Isat ¹ (A) @25°C	Irms ² (A) @25°C
SMHC2511-R10MHF	0.10	1.50	1.70	60.00	32.50
SMHC2511-R15MHF	0.15	1.90	2.40	52.00	26.00
SMHC2511-R20MHF	0.20	2.40	2.70	41.00	24.00
SMHC2511-R22MHF	0.22	2.50	2.80	40.00	23.00
SMHC2511-R33MHF	0.33	3.50	3.90	30.00	20.00
SMHC2511-R47MHF	0.47	4.00	4.20	26.00	17.50
SMHC2511-R68MHF	0.68	5.00	5.50	25.00	15.50
SMHC2511-R82MHF	0.82	6.70	8.00	24.00	13.00
SMHC2511-1R0MHF	1.0	9.00	10.00	22.0	11.00
SMHC2511-1R5MHF	1.5	14.00	15.00	18.0	9.00
SMHC2511-2R2MHF	2.2	18.00	20.00	14.00	8.00
SMHC2511-3R3MHF	3.3	28.00	30.00	13.50	6.00
SMHC2511-4R7MHF	4.7	37.00	40.00	10.00	5.50
SMHC2511-6R8MHF	6.8	54.00	60.00	8.00	4.50
SMHC2511-8R2MHF	8.2	64.00	68.00	7.50	4.00
SMHC2511-100MHF	10.0	102.00	105.00	7.00	3.00

3. Mechanical Dimensions (unit: mm):

A ±	B ±	C	D ±	E ±
0.20	0.30	Max.	0.30	0.50
6.60	7.10	3.00	3.00	1.60

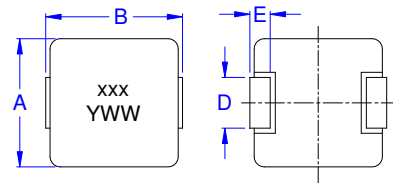

Part Marking:
xxx : inductance value in uH.
YWW: Y is Year Code , WW is week.

Pad Dimension	SMHC2511
F	7.40 Typ.
G	3.70 Typ.
H	3.50 Typ.

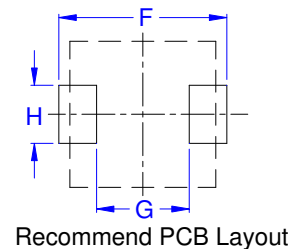

Notes:

1. Isat: DC current that causes inductance to drop 30%(Typ.) from OCL (Ta=25°C).
2. Irms: DC current for an approximate temperature rise of 40°C without core loss. Derating is necessary for AC currents. PCB pad layout, trace thickness and width, air-flow and proximity of other heat generating components will affect the temperature rise. It is recommended the part temperature not exceed 125° C under worst case operating conditions as verified in the end application.
3. Test conditions: 100KHz, 1.0V, 25°C ambient temperature .
4. Operating Temperature Range: -55°C to 125°C .

● New York 1 914 347 2474 ● Taipei 886 2 2698 8669 ● Kaohsiung 886 7 350 2275
 ● Japan 81 568 85 2830 ● Shenzhen 86 755 8418 6263 ● Shanghai 86 21 5424 5141 ● Hong Kong 852 9688 9767
 ● sales@ITG-Electronics.com ● www.ITG-Electronics.com Revision E.1: May 17 , 2017

*Due to continuous product improvement, all specifications are subject to change without prior notice. Kindly contact an ITG field application engineer or a sales representative prior to purchase.



SMHC2511 Series



4. Inductance vs. Current vs. Temperature Rise Characteristics of SMHC2511 Series :

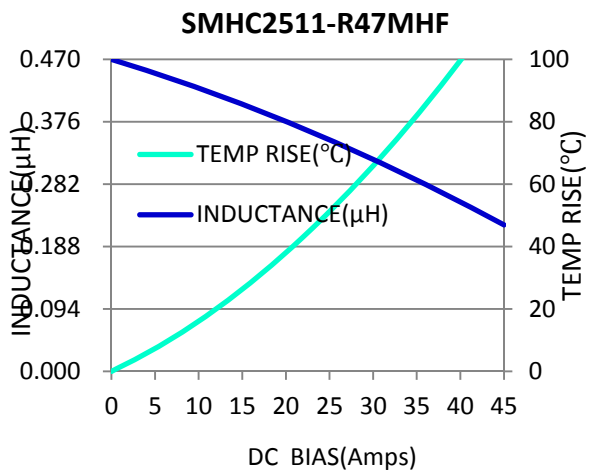
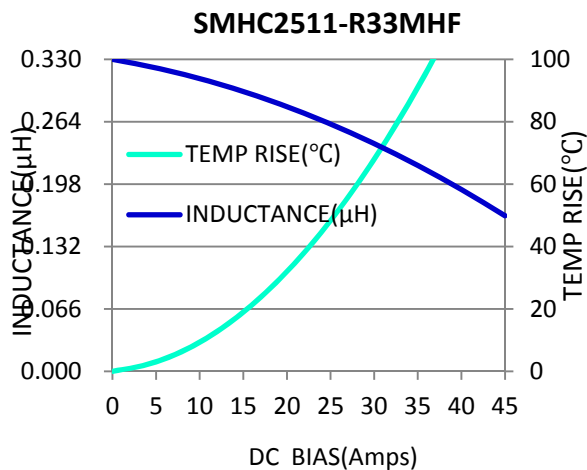
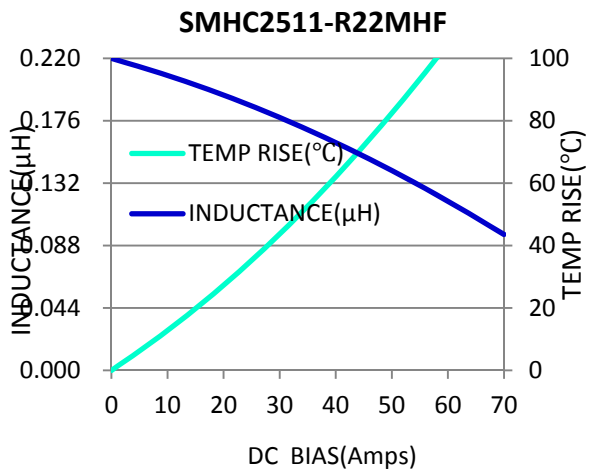
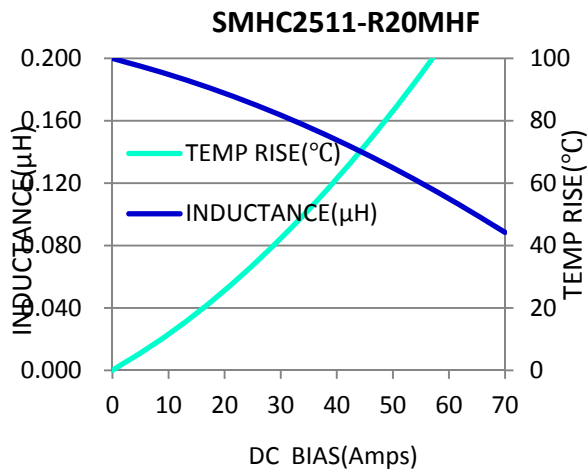
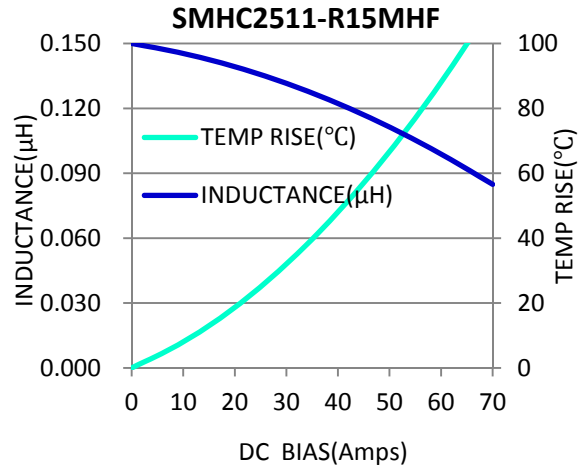
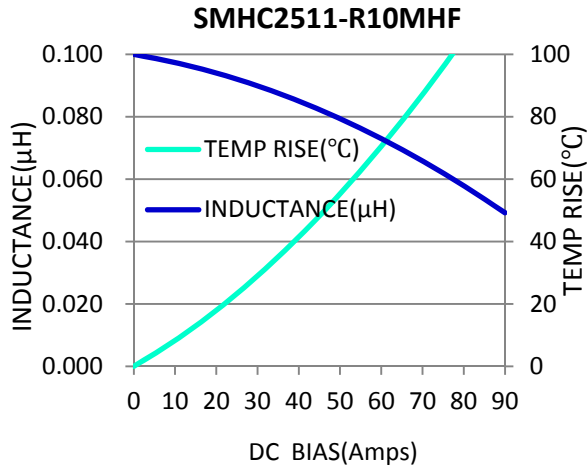

● New York 1 914 347 2474 ● Taipei 886 2 2698 8669 ● Kaohsiung 886 7 350 2275
 ● Japan 81 568 85 2830 ● Shenzhen 86 755 8418 6263 ● Shanghai 86 21 5424 5141 ● Hong Kong 852 9688 9767
 ● sales@ITG-Electronics.com ● www.ITG-Electronics.com Revision E.1: May 17, 2017

*Due to continuous product improvement, all specifications are subject to change without prior notice. Kindly contact an ITG field application engineer or a sales representative prior to purchase.



SMHC2511 Series



4. Inductance vs. Current vs. Temperature Rise Characteristics of SMHC2511 Series :

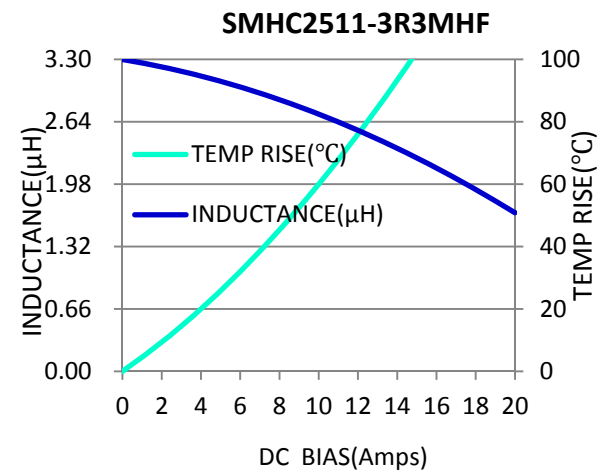
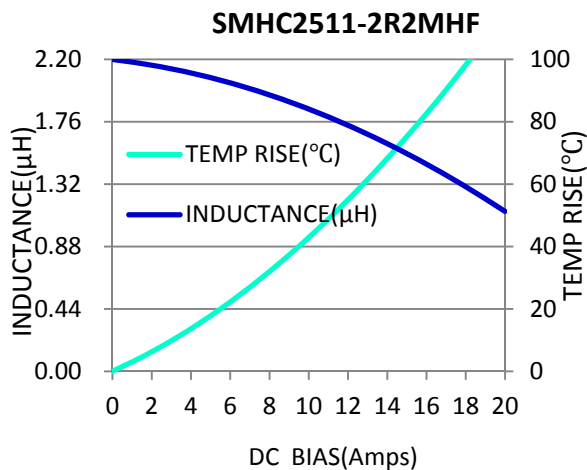
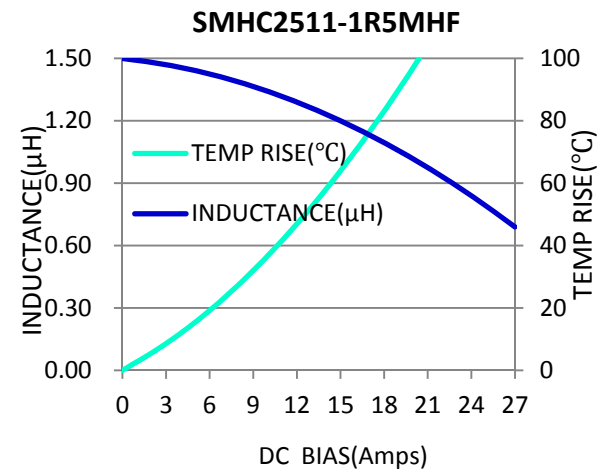
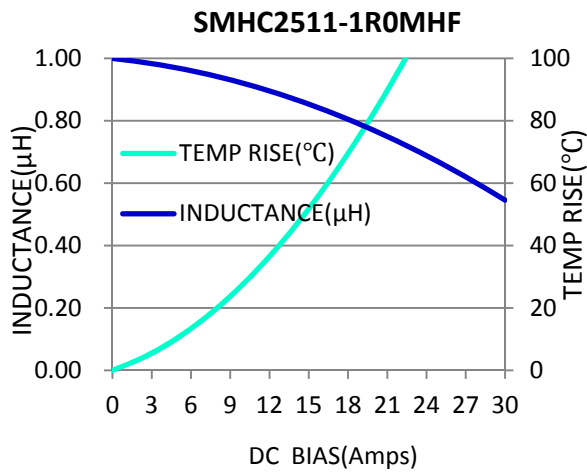
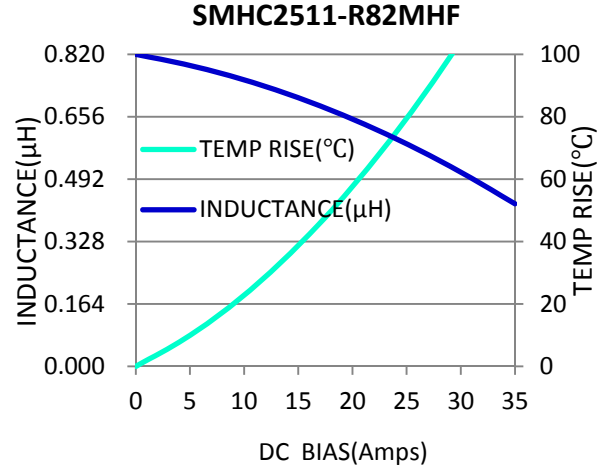
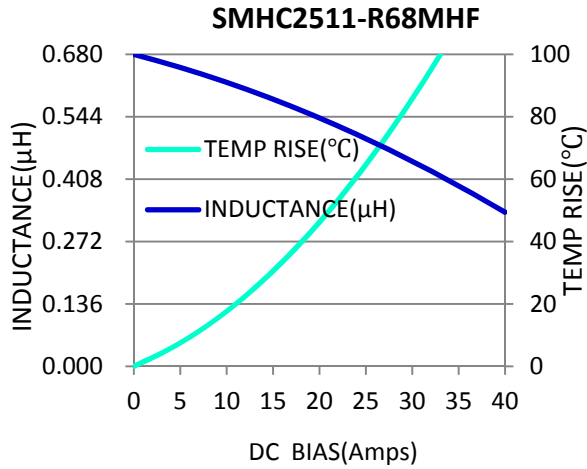

● New York 1 914 347 2474 ● Taipei 886 2 2698 8669 ● Kaohsiung 886 7 350 2275
 ● Japan 81 568 85 2830 ● Shenzhen 86 755 8418 6263 ● Shanghai 86 21 5424 5141 ● Hong Kong 852 9688 9767
 ● sales@ITG-Electronics.com ● www.ITG-Electronics.com Revision E.1: May 17, 2017

*Due to continuous product improvement, all specifications are subject to change without prior notice. Kindly contact an ITG field application engineer or a sales representative prior to purchase.



SMHC2511 Series



4. Inductance vs. Current vs. Temperature Rise Characteristics of SMHC2511 Series :

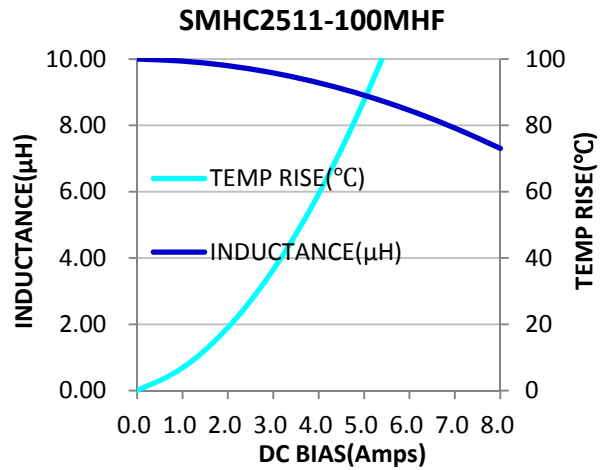
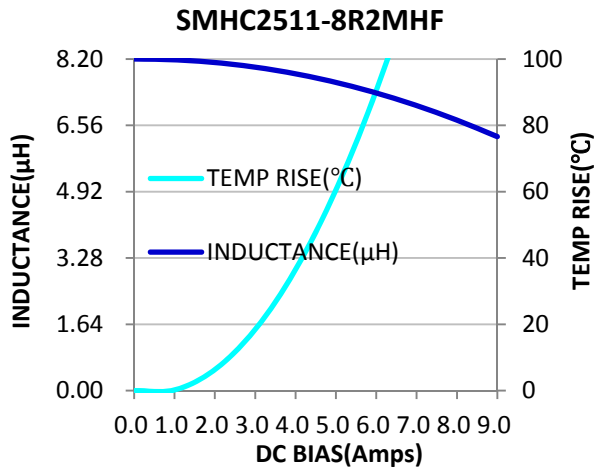
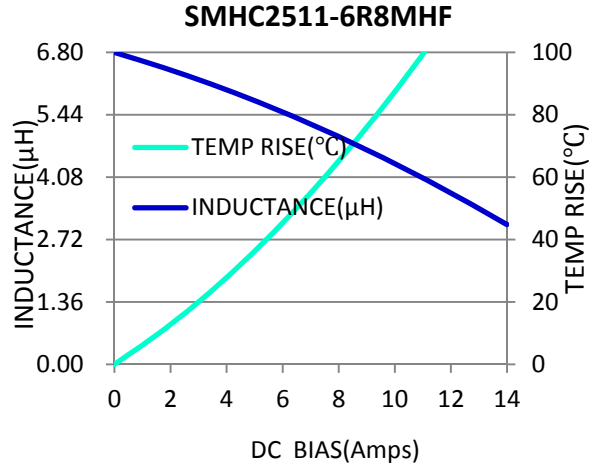
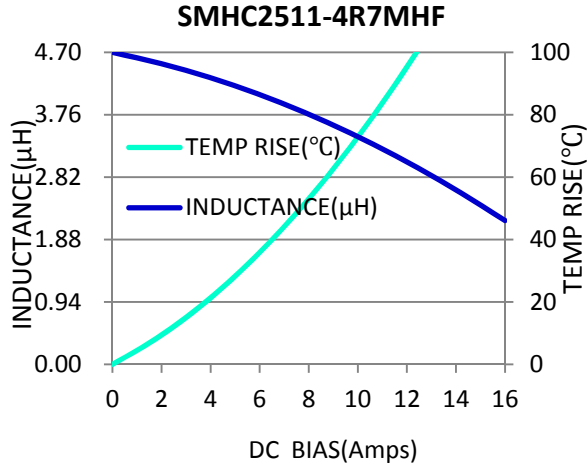

● New York 1 914 347 2474 ● Taipei 886 2 2698 8669 ● Kaohsiung 886 7 350 2275
 ● Japan 81 568 85 2830 ● Shenzhen 86 755 8418 6263 ● Shanghai 86 21 5424 5141 ● Hong Kong 852 9688 9767
 ● sales@ITG-Electronics.com ● www.ITG-Electronics.com Revision E.1: May 17, 2017

*Due to continuous product improvement, all specifications are subject to change without prior notice. Kindly contact an ITG field application engineer or a sales representative prior to purchase.



SMHC2511 Series



5. PACKAGE SPECIFICATION.(UNIT:mm):

(1).ENCAPSULATION MODE:

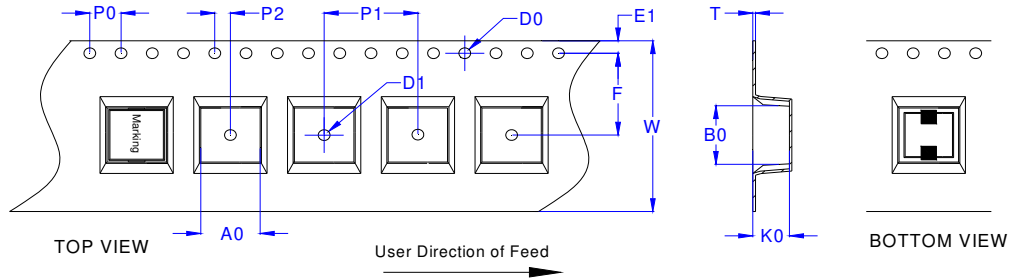

(2).DIMENSION(mm):

W	A0	B0	K0	P1	P0	P2	D0	D1	F	E1	T
16.0±0.30	7.0±0.10	7.5±0.10	3.4±0.15	12.0±0.10	4.0±0.10	2.0±0.10	1.5±0.10	1.5±0.10	7.5±0.10	1.75±0.10	0.4±0.05

(3).REEL SIZE:

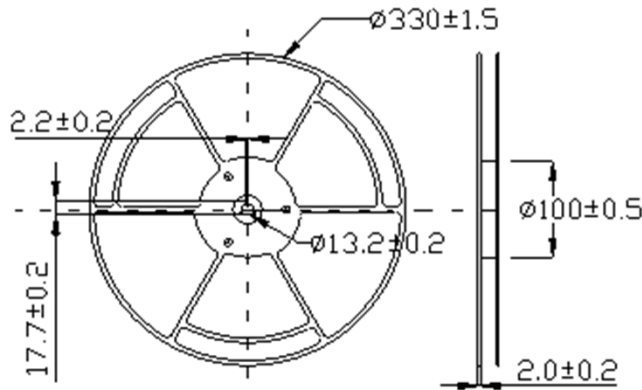

(4).PACKAGE MODE:

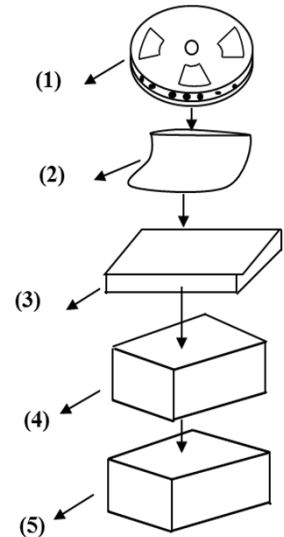

(5).PACKAGING LIST:

No.	Packing Part	Dimension (mm)	Material	Quantity
1	Reel	330	Plastic	1000PCS / Reel
2	Bag	450 X 360 X 0.075	Plastic	1Reel / Bag
3	Small Box	340 X 335 X 45	Paper	2Bag / Small Box
4	Middle Box	356 X 350 X 226	Paper	4Small Boxes / Middle Box
5	Outer Box	378 X 362 X 252	Paper	1Middle Box / Outer Box

(6).WEIGHT: N.W: 0.79g/pcs TOTAL6.32Kg(APPROX) , G.W: TOTA11.92Kg(APPROX).

(7).Storage conditions: -40°C~85°C ,75%RH (Max.).

● New York 1 914 347 2474 ● Taipei 886 2 2698 8669 ● Kaohsiung 886 7 350 2275
 ● Japan 81 568 85 2830 ● Shenzhen 86 755 8418 6263 ● Shanghai 86 21 5424 5141 ● Hong Kong 852 9688 9767
 ● sales@ITG-Electronics.com ● www.ITG-Electronics.com Revision E.1: May 17, 2017

*Due to continuous product improvement, all specifications are subject to change without prior notice. Kindly contact an ITG field application engineer or a sales representative prior to purchase.



SMHC2511 Series



6.RELIABILITY TEST:

6.1 Mechanical Reliability		
Item	Specification and Requirement	Test Method
Solderability	The surface of terminal immersed shall be minimum of 95% covered with a new coating of solder	Solder heat proof: 1. Preheating: 160 ± 10 °C 2. Retention time: 245 ± 5 °C for 2 ± 0.5 seconds
Vibration	Inductance change: Within ± 10% Without mechanical damage such as break	1. Vibration frequency: (10 Hz to 55 Hz to 10Hz) in 60 seconds as a period 2. Vibration time: Period cycled for 2 hours in each of 3 mutual perpendicular directions. 3. Amplitude: 1.5 mm max.
Shock	Inductance change: Within ±10% Without mechanical damage such as break	1. Peak value: 100 G 2. Duration of pulse: 11ms 3. 3 times in each positive and negative direction of 3 mutual perpendicular directions.
6.2 Endurance Reliability		
Thermal Shock	Inductance change: Within ± 10% Without distinct damage in appearance	1. Repeat 100 cycles as follow: (-55 ± 2 °C; 30 ± 3 min) → (Room temp., 5 min) → (+125 ± 2 °C, 30 ± 3 min) → (Room temp., 5 min) 2. Recovery: 48 + 4 / -0 hours of recovery under the standard condition after the test.
High Temperature Resistance	Inductance change: Within ± 10% Without distinct damage in appearance	1. Environment condition: 85 ± 2 °C Applied Current: Rated current 2. Duration: 1000 + 4 / -0 hours
Humidity Resistance	Inductance change: Within ± 10% Without distinct damage in appearance	1. Environment condition: 60 ± 2 °C Humidity: 90–95% Applied Current: Rated current 2. Duration: 1000 + 4 / -0 hours
Low Temperature Store	Inductance change: Within ± 10% Without distinct damage in appearance	Store temperature: -55 ± 2 °C, 1000 + 4 / -0 hours
High Temperature Store	Inductance change: Within ± 10% Without distinct damage in appearance	Store temperature: +125 ± 2 °C, 1000 + 4 / -0 hours

● New York 1 914 347 2474 ● Taipei 886 2 2698 8669 ● Kaohsiung 886 7 350 2275
 ● Japan 81 568 85 2830 ● Shenzhen 86 755 8418 6263 ● Shanghai 86 21 5424 5141 ● Hong Kong 852 9688 9767
 ● sales@ITG-Electronics.com ● www.ITG-Electronics.com Revision E.1: May 17, 2017

*Due to continuous product improvement, all specifications are subject to change without prior notice. Kindly contact an ITG field application engineer or a sales representative prior to purchase.



SMHC2511 Series



Soldering Reflow Chart

Stage	Precaution	Recommended temperature profile
<p>Reflow soldering</p>	<p>Temperature profile can be referenced after confirming of adhesion , temperature of resistance to soldering heat , component size , soldering etc. sufficient .</p> <p>Note: please refer to the latest IPC/JEDEC J-STD-020: "Moisture/Reflow Sensitivity Classification for Nonhermetic Solid State Surface Mount Devices"</p>	<p>The chart shows a temperature profile starting at 25°C. It ramps up to 125°C, which takes 150s to 210s. From 125°C, it continues to ramp up to a peak of 260°C, which takes 10s (MAX). After the peak, it cools down, which takes 60s to 90s. The cooling phase is labeled 'Natural cooling'. A shaded cyan area highlights the ramp-up phase from 125°C to the peak.</p>

● New York 1 914 347 2474 ● Taipei 886 2 2698 8669 ● Kaohsiung 886 7 350 2275
 ● Japan 81 568 85 2830 ● Shenzhen 86 755 8418 6263 ● Shanghai 86 21 5424 5141 ● Hong Kong 852 9688 9767
 ● sales@ITG-Electronics.com ● www.ITG-Electronics.com Revision E.1: May 17 , 2017

**Due to continuous product improvement, all specifications are subject to change without prior notice. Kindly contact an ITG field application engineer or a sales representative prior to purchase.*