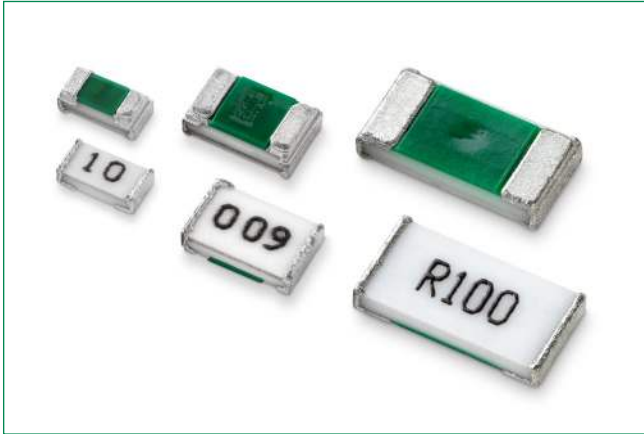

Two-Terminal Surface Mount Resistor

WSTM Series

HF **RoHS** **Pb**

Description

Littelfuse WSTM Series low ohm current sense resistor is designed with long term stability in mind. This series is durable, excels at heat dissipation. The small package is optimal for most applications.

Features

- Low TCR
- Optimal linearity in I / V conversion
- Ceramic substrate

Benefits

- Small size
- High voltage

Application

- Power management
- Low ESL

Additional Information

Resources

Accessories

Samples

Two-Terminal Surface Mount Resistor

WSTM Series

Electrical Specifications

Part Number	Size		Resistance Value		Power Rating (W)	TCR (ppm / °C)	Standard Package Quantity
	Inch	mm	Ro (mΩ)	Rt (%)			
WSTM0603DLR006FNR	0603	1608	6	±1.0%	0.5	±75	5000
WSTM0603DLR009FNR	0603	1608	9	±1.0%	0.5	±75	5000
WSTM0603QLR010FNR	0603	1608	10	±1.0%	0.5	±50	5000
WSTM0603QLR015FNR	0603	1608	15	±1.0%	0.5	±50	5000
WSTM0603QLR020FNR	0603	1608	20	±1.0%	0.5	±50	5000
WSTM0603QLR022FNR	0603	1608	22	±1.0%	0.5	±50	5000
WSTM0603QLR030FNR	0603	1608	30	±1.0%	0.5	±50	5000
WSTM0603QLR033FNR	0603	1608	33	±1.0%	0.5	±50	5000
WSTM0805DLR003FNR	0805	2012	3	±1.0%	0.75	±75	5000
WSTM0805QLR004FNR	0805	2012	4	±1.0%	0.75	±50	5000
WSTM0805QLR005FNR	0805	2012	5	±1.0%	0.75	±50	5000
WSTM0805QLR007FNR	0805	2012	7	±1.0%	0.75	±50	5000
WSTM0805QLR008FNR	0805	2012	8	±1.0%	0.75	±50	5000
WSTM0805QLR009FNR	0805	2012	9	±1.0%	0.75	±50	5000
WSTM0805QLR013FNR	0805	2012	13	±1.0%	0.75	±50	5000
WSTM0805QLR015FNR	0805	2012	15	±1.0%	0.75	±50	5000
WSTM0805QLR016FNR	0805	2012	16	±1.0%	0.75	±50	5000
WSTM0805QLR018FNR	0805	2012	18	±1.0%	0.75	±50	5000
WSTM0805QLR020FNR	0805	2012	20	±1.0%	0.75	±50	5000
WSTM0805QLR022FNR	0805	2012	22	±1.0%	0.75	±50	5000
WSTM0805QLR024FNR	0805	2012	24	±1.0%	0.75	±50	5000
WSTM0805QLR030FNR	0805	2012	30	±1.0%	0.75	±50	5000
WSTM0805QLR033FNR	0805	2012	33	±1.0%	0.75	±50	5000
WSTM0805QLR047FNR	0805	2012	47	±1.0%	0.75	±50	5000
WSTM0805QLR100FNR	0805	2012	100	±1.0%	0.75	±50	5000
WSTM0805QLR165FNR	0805	2012	165	±1.0%	0.75	±50	5000
WSTM0805QLR220FNR	0805	2012	220	±1.0%	0.75	±50	5000
WSTM0805QLR470FNR	0805	2012	470	±1.0%	0.75	±50	5000
WSTM1206QLR004FNR	1206	3216	4	±1.0%	1	±50	5000
WSTM1206QLR005FNR	1206	3216	5	±1.0%	1	±50	5000
WSTM1206QLR006FNR	1206	3216	6	±1.0%	1	±50	5000
WSTM1206QLR007FNR	1206	3216	7	±1.0%	1	±50	5000
WSTM1206QLR008FNR	1206	3216	8	±1.0%	1	±50	5000
WSTM1206QLR009FNR	1206	3216	9	±1.0%	1	±50	5000
WSTM1206QLR010FNR	1206	3216	10	±1.0%	1	±50	5000
WSTM1206QLR011FNR	1206	3216	11	±1.0%	1	±50	5000
WSTM1206QLR012FNR	1206	3216	12	±1.0%	1	±50	5000
WSTM1206QLR015FNR	1206	3216	15	±1.0%	1	±50	5000
WSTM1206QLR016FNR	1206	3216	16	±1.0%	1	±50	5000
WSTM1206QLR018FNR	1206	3216	18	±1.0%	1	±50	5000
WSTM1206QLR020FNR	1206	3216	20	±1.0%	1	±50	5000

Two-Terminal Surface Mount Resistor

WSTM Series

Electrical Specifications

Part Number	Size		Resistance Value		Power Rating (W)	TCR (ppm / °C)	Standard Package Quantity
	Inch	mm	Ro (mΩ)	Rt (%)			
WSTM1206QLR022FNR	1206	3216	22	±1.0%	1	±50	5000
WSTM1206QLR024FNR	1206	3216	24	±1.0%	1	±50	5000
WSTM1206QLR027FNR	1206	3216	27	±1.0%	1	±50	5000
WSTM1206QLR028FNR	1206	3216	28	±1.0%	1	±50	5000
WSTM1206QLR030FNR	1206	3216	30	±1.0%	1	±50	5000
WSTM1206QLR036FNR	1206	3216	36	±1.0%	1	±50	5000
WSTM1206QLR039FNR	1206	3216	39	±1.0%	1	±50	5000
WSTM1206QLR043FNR	1206	3216	43	±1.0%	1	±50	5000
WSTM1206QLR047FNR	1206	3216	47	±1.0%	1	±50	5000
WSTM1206QLR056FNR	1206	3216	56	±1.0%	1	±50	5000
WSTM1206QLR062FNR	1206	3216	62	±1.0%	1	±50	5000
WSTM1206QLR075FNR	1206	3216	75	±1.0%	1	±50	5000
WSTM1206QLR120FNR	1206	3216	120	±1.0%	1	±50	5000
WSTM1206QLR130FNR	1206	3216	130	±1.0%	1	±50	5000
WSTM1206QLR140FNR	1206	3216	140	±1.0%	1	±50	5000
WSTM1206QLR160FNR	1206	3216	160	±1.0%	1	±50	5000
WSTM1206QLR240FNR	1206	3216	240	±1.0%	1	±50	5000
WSTM1206QLR270FNR	1206	3216	270	±1.0%	1	±50	5000
WSTM1206QLR330FNR	1206	3216	330	±1.0%	1	±50	5000
WSTM1206QLR360FNR	1206	3216	360	±1.0%	1	±50	5000
WSTM1206QLR402FNR	1206	3216	402	±1.0%	1	±50	5000
WSTM1206QLR430FNR	1206	3216	430	±1.0%	1	±50	5000
WSTM1206QLR470FNR	1206	3216	470	±1.0%	1	±50	5000
WSTM1206QLR499FNR	1206	3216	499	±1.0%	1	±50	5000
WSTM2512DLR002FYR	2512	6432	2	±1.0%	2	±75	4000
WSTM2512DLR003FYR	2512	6432	3	±1.0%	2	±75	4000
WSTM2512QLR005FYR	2512	6432	5	±1.0%	2	±50	4000
WSTM2512QLR006FYR	2512	6432	6	±1.0%	2	±50	4000
WSTM2512QLR007FYR	2512	6432	7	±1.0%	2	±50	4000
WSTM2512QLR010FYR	2512	6432	10	±1.0%	2	±50	4000
WSTM2512QLR012FYR	2512	6432	12	±1.0%	2	±50	4000
WSTM2512QLR015FYR	2512	6432	15	±1.0%	2	±50	4000
WSTM2512QLR016FYR	2512	6432	16	±1.0%	2	±50	4000
WSTM2512QLR018FYR	2512	6432	18	±1.0%	2	±50	4000
WSTM2512QLR020FYR	2512	6432	20	±1.0%	2	±50	4000
WSTM2512QLR022FYR	2512	6432	22	±1.0%	2	±50	4000
WSTM2512QLR027FYR	2512	6432	27	±1.0%	2	±50	4000
WSTM2512QLR030FYR	2512	6432	30	±1.0%	2	±50	4000
WSTM2512QLR033FYR	2512	6432	33	±1.0%	2	±50	4000
WSTM2512QLR036FYR	2512	6432	36	±1.0%	2	±50	4000
WSTM2512QLR051FYR	2512	6432	51	±1.0%	2	±50	4000

Two-Terminal Surface Mount Resistor

WSTM Series

Electrical Specifications

Part Number	Size		Resistance Value		Power Rating (W)	TCR (ppm / °C)	Standard Package Quantity
	Inch	mm	Ro (mΩ)	Rt (%)			
WSTM2512QLR068FYR	2512	6432	68	±1.0%	2	±50	4000
WSTM2512QLR075FYR	2512	6432	75	±1.0%	2	±50	4000
WSTM2512QLR120FYR	2512	6432	120	±1.0%	2	±50	4000
WSTM2512QLR130FYR	2512	6432	130	±1.0%	2	±50	4000
WSTM2512QLR140FYR	2512	6432	140	±1.0%	2	±50	4000
WSTM2512QLR180FYR	2512	6432	180	±1.0%	2	±50	4000
WSTM2512QLR240FYR	2512	6432	240	±1.0%	2	±50	4000
WSTM2512QLR300FYR	2512	6432	300	±1.0%	2	±50	4000
WSTM2512QLR330FYR	2512	6432	330	±1.0%	2	±50	4000
WSTM2512QLR360FYR	2512	6432	360	±1.0%	2	±50	4000
WSTM2512QLR390FYR	2512	6432	390	±1.0%	2	±50	4000
WSTM2512QLR430FYR	2512	6432	430	±1.0%	2	±50	4000
WSTM2512QLR470FYR	2512	6432	470	±1.0%	2	±50	4000
WSTM4527RLR007FMR	4527	11470	7	±1.0%	4	±100	1000
WSTM4527QLR015FMR	4527	11470	15	±1.0%	4	±50	1000
WSTM4527QLR020FMR	4527	11470	20	±1.0%	4	±50	1000

Note: Resistors are available in steps of 1 mΩ. Ratings not indicated in the above table may be available on request.

Two-Terminal Surface Mount Resistor

WSTM Series

Temperature De-rating Curve

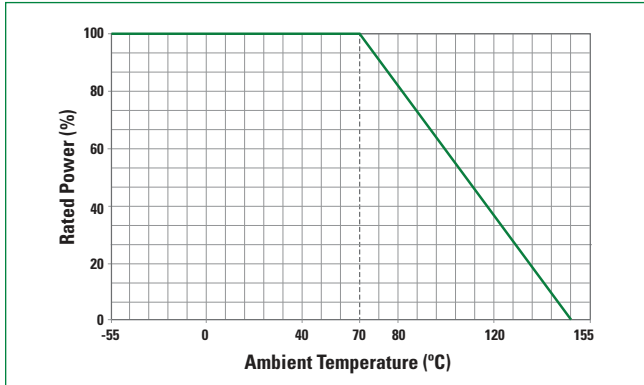

Storage / Environment Conditions

Products should be stored under the following environmental conditions.

Temperature:	+5 to +35 °C
Humidity:	45 to 85% relative humidity
Moisture Sensitivity Level:	1, J-STD-020

Do not keep products in environments where they may be subject to particulate contamination or harmful gases such as sulfuric acid or hydrogen chloride as it may cause oxidation on electrodes, resulting poor solderability.

Products should be stored in a space that does not expose to high temperatures, vibration, or direct sunlight.

Products should be stored in the original airtight packaging until use.

Soldering Parameters–Wave Soldering

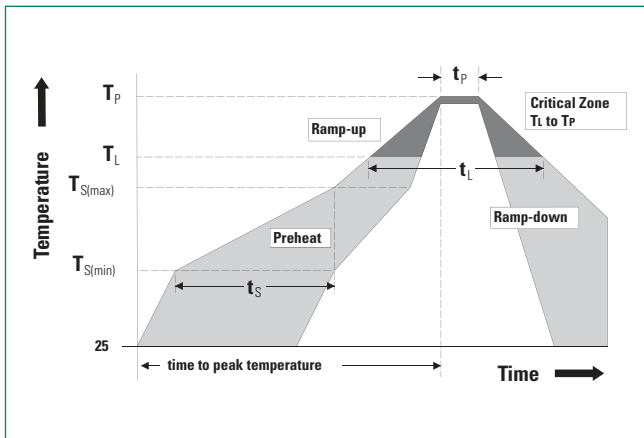

Profile Feature	Pb-Free Assembly
Average Ramp-Up Rate ($T_{S(max)}$ to T_p)	3 °C / second max
Preheat	
Temperature Minimum ($T_{S(min)}$)	150 °C
Temperature Maximum ($T_{S(max)}$)	200 °C
Time ($T_{S(min)}$ to $T_{S(max)}$)	60–180 seconds
Time maintained above	
Temperature Minimum (T_L)	217 °C
Time (t_L)	60–150 seconds
Peak Temperature (T_p)	260 +0 °C
Time within 5 °C of Actual Peak Temperature (t_p)	20–40 seconds
Ramp-Down Rate	6 °C / second Maximum
Time 25 °C to Peak Temperature	8 minutes Maximum

Two-Terminal Surface Mount Resistor

WSTM Series

Reliability Specifications

Test	Procedure	Specifications
Resistance Data	Resistance data at 25 °C	Must meet datasheet requirements
TCR Data	TCR data at 25 °C and 125 °C	Must meet datasheet requirements
Dimensional Data	Measure all dimensions specified in datasheet	Must meet datasheet requirements
Short Time Overload IEC60115-1 4.13	Applied voltage: 2.5X rated power. Test duration: 5 seconds Test temperature: 25 ± 2°C	±(1.0%+0.5mΩ)
Moisture Load Life IEC60115-1 4.25	Test Temperature: 60 °C ± 2 °C, RH: 95% Applied voltage: rated voltage Test period: 1,000 hours with power cycling as follows: 90 min. power ON/30 min. power OFF.	±(2.0%+0.5mΩ)
Temperature Cycle (Thermal Shock) IEC60115-1 4.19	Repeat 100 cycles as follows: -55 ± 3 °C (30 min.) / +155 ±3 °C (30 min.) Transition time of 1 minute maximum	±(1.0%+0.5mΩ)
Resistance To Solder Heat IEC60115-1 4.18	Through reflow Parts are subjected to 3 reflow cycles	±(1.0%+0.5mΩ)
High Temperature Exposure IEC60115-1 4.25	Test Temperature: Maximum rated operational temperature Test period: 1,000 hours No electrical load	±(1.0%+0.5mΩ)
Low Temperature Storage IEC60115-1 4.25	Test temperature: -55 ± 2 °C Test period: 1,000 hours	±(1.0%+0.5mΩ)
Load Life at 70 °C IEC60115-1 4.25	V _{test} = V _{max} Test Temperature: 70 °C ± 2 °C Test period: 1,000 hours with power cycling as follows: 90 min. power ON / 30 min. power OFF.	±(2.0%+0.5mΩ)
Substrate Bending IEC60115-1 4.33	Span between fulcrums: 90 mm Bend width: 2 mm Test board: glass-epoxy Thickness: 1.60 mm	±(1.0%+0.5mΩ)
Mechanical Shock IEC60115-1 4.21	Force: 100G Test Duration: 6 milliseconds	±(1.0%+0.5mΩ)
Solderability IEC60115-1 4.17	Dipped into molten solder for 3 ±1 seconds at 245 ± 5 °C	New solder coverage of 95% minimum

Two-Terminal Surface Mount Resistor

WSTM Series

Dimensions

All dimensions in mm

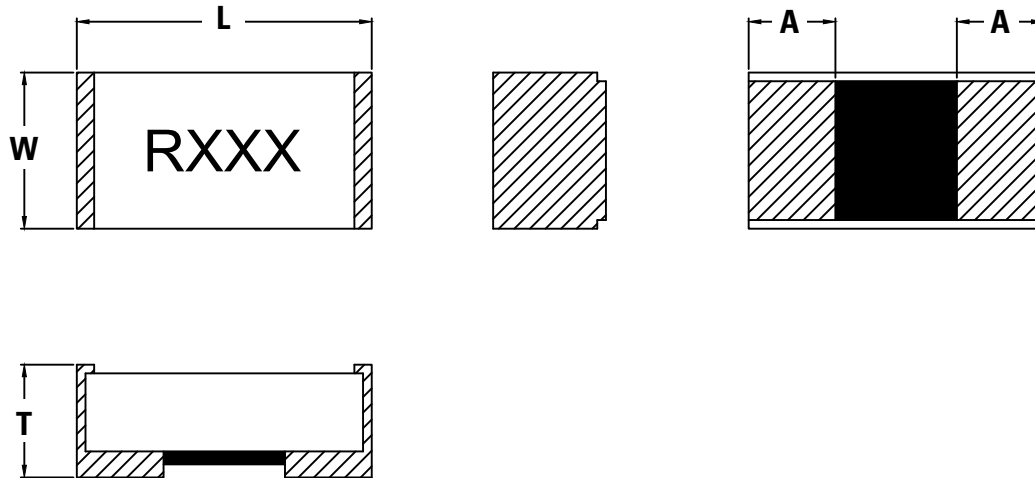

Part Number	W	L	T	A
WSTM0603 R005	0.90±0.20	1.70±0.20	0.65±0.15	0.50±0.20
WSTM0603 R006~R100	0.90±0.20	1.70±0.20	0.65±0.15	0.40±0.20
WSTM0805 R003	1.35±0.20	2.10±0.20	0.65±0.20	0.65±0.20
WSTM0805 R004~R500	1.35±0.20	2.10±0.20	0.65±0.20	0.50±0.20
WSTM1206 R003	1.70±0.20	3.30±0.20	0.65±0.20	1.20±0.30
WSTM1206 R004~R700	1.70±0.20	3.30±0.20	0.65±0.20	0.68±0.30
WSTM2010 R002~R003	2.60±0.20	5.10±0.20	0.65±0.20	2.10±0.30
WSTM2010 R004~R700	2.60±0.20	5.10±0.20	0.65±0.20	0.70±0.30
WSTM2512 R002	3.20±0.30	6.40±0.30	0.65±0.20	2.80±0.30
WSTM2512 R003	3.20±0.30	6.40±0.30	0.65±0.20	2.60±0.30
WSTM2512 R004~R700	3.20±0.30	6.40±0.30	0.65±0.20	1.05±0.30
WSTM3921 R004~R100	5.10±0.30	11.10±0.30	0.65±0.20	2.36±0.30
WSTM4527 R002	7.10±1.00	11.60±1.00	0.65±0.30	5.00±0.40
WSTM4527 R003~R100	7.10±1.00	11.60±1.00	0.65±0.30	2.70±0.40

Two-Terminal Surface Mount Resistor

WSTM Series

Recommended Land Pattern

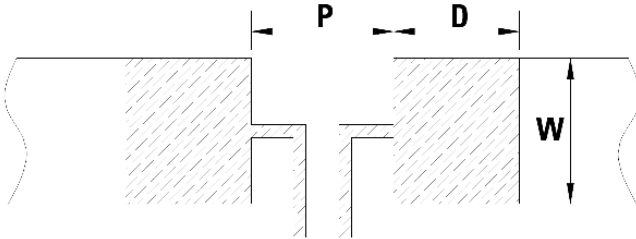

Part Number	P	W	D	Loading
WSTM0603 R005	0.50	0.92	1.35	0.50 W
WSTM0603 R006~R100	0.60	0.92	1.30	0.50 W
WSTM0805 R003	0.50	1.44	1.55	0.75 W
WSTM0805 R004~R500	0.80	1.44	1.40	0.75 W
WSTM1206 R003	0.60	1.84	2.10	1.0 W
WSTM1206 R004~R700	1.20	1.84	1.80	1.0 W
WSTM2010 R002~R003	0.70	2.88	3.65	1.5 W
WSTM2010 R004~R700	2.70	2.88	2.65	1.5 W
WSTM2512 R002	0.60	3.57	4.35	2.0 W
WSTM2512 R003	0.90	3.57	4.20	2.0 W
WSTM2512 R004~R700	3.10	3.57	3.10	2.0 W
WSTM4527 R002	1.20	8.05	6.65	4.0 W
WSTM4527 R003~R100	5.20	8.05	4.65	4.0 W

Packaging

Part Number	Halogen Free	Packaging Option	Quantity	Quantity & Packaging Codes
WSTM0603	Yes	Tape and Reel	5000	NR
WSTM0805	Yes	Tape and Reel	5000	NR
WSTM1206	Yes	Tape and Reel	5000	NR
WSTM2010	Yes	Tape and Reel	4000	YR
WSTM2512	Yes	Tape and Reel	4000	YR
WSTM3921	Yes	Tape and Reel	2000	PR
WSTM4527	Yes	Tape and Reel	1000	MR

Part Numbering System

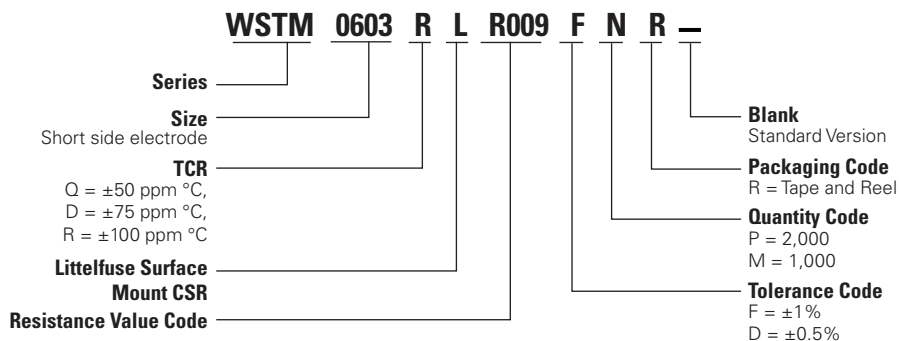

Two-Terminal Surface Mount Resistor

WSTM Series

Tape and Reel Specifications

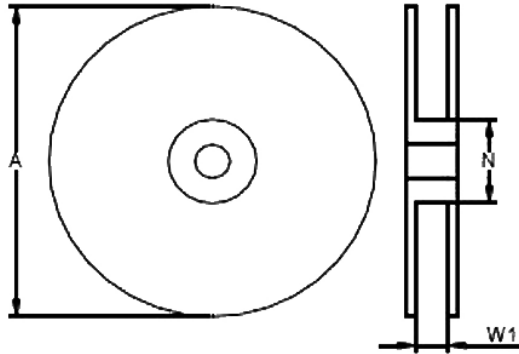

Part Number	A±5 (mm)	N±2 (mm)	W1±1 (mm)
WSTM0603	178	60	9.0
WSTM0805	178	60	9.0
WSTM1206	178	60	9.0
WSTM2010	178	60	13
WSTM2512	178	60	13
WSTM3921	178	60	24.5
WSTM4527	178	60	24.5

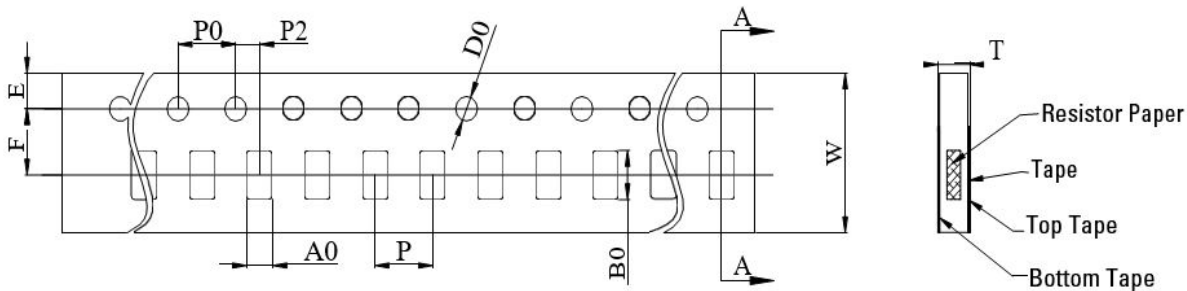

Part Number	W	P0	P	P2	A0	B0	D0	F	E	T	/	/
WSTM0603	8.00±0.30	4.00±0.10	4.00±0.10	2.00±0.10	1.10±0.10	1.90±0.10	1.50±0.10	3.50±0.10	1.75±0.10	0.75±0.10	/	/
WSTM0805	8.00±0.30	4.00±0.10	4.00±0.10	2.00±0.10	1.55±0.10	2.30±0.10	1.50±0.10	3.50±0.10	1.75±0.10	0.87±0.10	/	/
WSTM1206	8.00±0.30	4.00±0.10	4.00±0.10	2.00±0.10	2.05±0.20	3.65±0.20	1.50±0.10	3.50±0.10	1.75±0.10	0.87±0.10	/	/

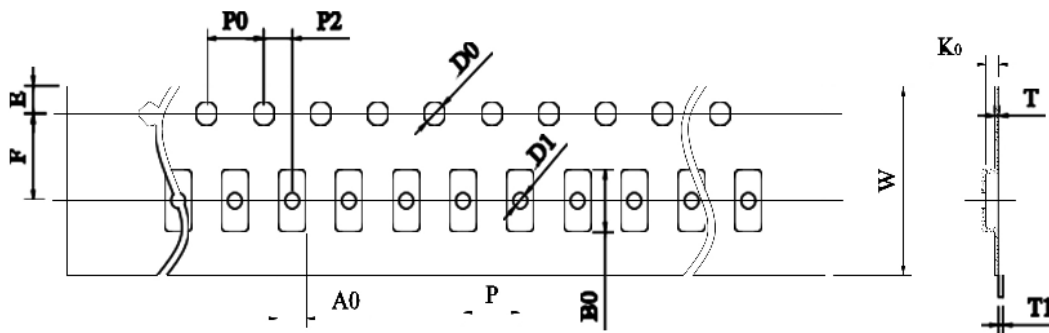

Part Number	W	P0	P	P2	A0	B0	D0	F	E	T	T1	K0
WSTM2010	12.0±0.30	4.00±0.10	4.00±0.10	2.00±0.10	2.85±0.20	5.45±0.20	1.50±0.10	5.50±0.10	1.75±0.10	0.25±0.10	Max 0.10	0.80±0.20
WSTM2512	12.0±0.30	4.00±0.10	4.00±0.10	2.00±0.10	3.40±0.20	6.75±0.20	1.50±0.10	5.50±0.10	1.75±0.10	0.25±0.10	Max 0.10	1.00±0.20
WSTM3921	24.0±0.30	4.00±0.10	8.00±0.10	2.00±0.10	5.50±0.20	11.5±0.20	1.50±0.10	11.50±0.10	1.75±0.10	0.30±0.10	Max 0.10	0.90±0.20
WSTM4527	24.0±0.30	4.00±0.10	12.0±0.10	2.00±0.10	7.50±0.20	12.0±0.20	1.50±0.20	11.50±0.10	1.75±0.10	0.30±0.10	Max 0.10	0.90±0.20

Disclaimer Notice - Information furnished is believed to be accurate and reliable. However, users should independently evaluate the suitability of and test each product selected for their own applications. Littelfuse products are not designed for, and may not be used in, all applications. Read complete Disclaimer Notice at <http://www.littelfuse.com/disclaimer-electronics>.