



Main

Range of Product	Modicon M221
Product or Component Type	Logic controller
[Us] rated supply voltage	100...240 V AC
Discrete input number	14, discrete input IEC 61131-2 Type 1
Analogue input number	2 0...10 V
Discrete output type	Relay normally open
Discrete output number	10 relay
Discrete output voltage	5...125 V DC 5...250 V AC
Discrete output current	2 A

Complementary

Discrete I/O number	24
Maximum number of I/O expansion module	7 transistor output 7 relay output
Supply voltage limits	85...264 V
Network Frequency	50/60 Hz
Inrush current	40 A
Maximum power consumption in VA	55 VA 100...240 V with max number of I/O expansion module 32 VA 100...240 V without I/O expansion module
Power supply output current	0.52 A 5 V expansion bus 0.16 A 24 V expansion bus
Discrete input logic	Sink or source (positive/negative)
Discrete input voltage	24 V
Discrete input voltage type	DC
Analogue input resolution	10 bits
LSB value	10 mV
Conversion time	1 ms per channel + 1 controller cycle time analog input
Permitted overload on inputs	+/- 30 V DC 5 min maximum)analog input +/- 13 V DC permanent)analog input
Voltage state 1 guaranteed	>= 15 V input
Voltage state 0 guaranteed	<= 5 V input
Discrete input current	7 MA discrete input 5 mA fast input
Input impedance	3.4 kOhm discrete input 100 kOhm analog input 4.9 kOhm fast input
Response time	35 µs turn-off, I2...I5 input 10 ms turn-on output 10 ms turn-off output 5 µs turn-on, I0, I1, I6, I7 fast input 35 µs turn-on, other terminals input 5 µs turn-off, I0, I1, I6, I7 fast input 100 µs turn-off, other terminals input
Configurable filtering time	0 ms input 3 ms input 12 ms input
Output voltage limits	125 V DC 277 V AC
Maximum current per output common	4 A COM 2 7 A COM 0 7 A COM 1

The information provided in this documentation contains general descriptions and/or technical characteristics of the performance of the products contained herein. This documentation is not intended as a substitute for and is not to be used for determining suitability or reliability of these products for specific user applications. It is the duty of any such user or integrator to perform the appropriate and complete risk analysis, evaluation and testing of the products with respect to the relevant specific application or use thereof. Neither Schneider Electric Industries SAS nor any of its affiliates or subsidiaries shall be responsible or liable for misuse of the information contained herein.

Absolute accuracy error	+/- 1 % of full scale analog input
Electrical durability	100000 Cycles AC-12, 120 V, 240 VA, resistive 100000 Cycles AC-12, 240 V, 480 VA, resistive 300000 Cycles AC-12, 120 V, 80 VA, resistive 300000 Cycles AC-12, 240 V, 160 VA, resistive 100000 Cycles AC-15, cos phi = 0.35, 120 V, 60 VA, inductive 100000 Cycles AC-15, cos phi = 0.35, 240 V, 120 VA, inductive 300000 Cycles AC-15, cos phi = 0.35, 120 V, 18 VA, inductive 300000 Cycles AC-15, cos phi = 0.35, 240 V, 36 VA, inductive 100000 Cycles AC-14, cos phi = 0.7, 120 V, 120 VA, inductive 100000 Cycles AC-14, cos phi = 0.7, 240 V, 240 VA, inductive 300000 Cycles AC-14, cos phi = 0.7, 120 V, 36 VA, inductive 300000 Cycles AC-14, cos phi = 0.7, 240 V, 72 VA, inductive 100000 Cycles DC-12, 24 V, 48 W, resistive 300000 Cycles DC-12, 24 V, 16 W, resistive 100000 Cycles DC-13, 24 V, 24 W, inductive (L/R = 7 ms) 300000 cycles DC-13, 24 V, 7.2 W, inductive (L/R = 7 ms)
Switching frequency	20 switching operations/minute with maximum load
Mechanical durability	20000000 cycles relay output
Minimum load	1 mA 5 V DC relay output
Protection type	Without protection 5 A
Reset time	1 s
Memory capacity	256 kB user application and data RAM 10000 instructions 256 kB internal variables RAM
Data backed up	256 kB built-in flash memory backup of application and data
Data storage equipment	2 GB SD card optional)
Battery type	BR2032 lithium non-rechargeable 4 year(s)
Backup time	1 year 77 °F (25 °C) by interruption of power supply)
Execution time for 1 KInstruction	0.3 ms event and periodic task
Execution time per instruction	0.2 µs Boolean
Exct time for event task	60 µs response time
Maximum size of object areas	255 %C counters 8000 %MW memory words 512 %M memory bits 512 %KW constant words 255 %TM timers
Realtime clock	With
Clock drift	<= 30 s/month 77 °F (25 °C)
Regulation loop	Adjustable PID regulator up to 14 simultaneous loops
Counting input number	4 fast input (HSC mode) 100 kHz 32 bits
Counter function	A/B Single phase Pulse/direction
Integrated connection type	USB port mini B USB 2.0 Non isolated serial link serial 1 RJ45 RS485 Non isolated serial link serial 2 RJ45 RS232/RS485
Supply	Serial)serial link supply 5 V, <200 mA
Transmission rate	1.2...115.2 kbit/s (115.2 kbit/s by default) 49.21 ft (15 m) RS485 1.2...115.2 kbit/s (115.2 kbit/s by default) 9.84 ft (3 m) RS232 480 Mbit/s USB
Communication port protocol	USB port USB - SoMachine-Network Non isolated serial link Modbus master/slave - RTU/ASCII or SoMachine-Network
Local signalling	For PWR 1 LED (green) For RUN 1 LED (green) For module error (ERR) 1 LED (red) For SD card access (SD) 1 LED (green) For BAT 1 LED (red) For SL1 1 LED (green) For SL2 1 LED (green) For I/O state 1 LED per channel (green)
Electrical connection	Removable screw terminal block for inputs Removable screw terminal block for outputs Terminal block, 3 for connecting the 24 V DC power supply Connector, 4 for analogue inputs Mini B USB 2.0 connector for a programming terminal

Maximum cable distance between devices	Shielded cable <32.81 ft (10 m) fast input Unshielded cable <98.43 ft (30 m) output Unshielded cable <98.43 ft (30 m) digital input Unshielded cable <3.28 ft (1 m) analog input
Insulation	Between input and internal logic 500 V AC Non-insulated between analogue input and internal logic Non-insulated between analogue inputs Between supply and ground 1500 V AC Between sensor power supply and ground 500 V AC Between input and ground 500 V AC Between output and ground 1500 V AC Between supply and internal logic 2300 V AC Between sensor power supply and internal logic 500 V AC Between output and internal logic 2300 V AC Between Ethernet terminal and internal logic 500 V AC Between supply and sensor power supply 2300 V AC
Marking	CE
Sensor power supply	24 V DC 250 mA supplied by the controller
Mounting support	Top hat type TH35-15 rail IEC 60715 Top hat type TH35-7.5 rail IEC 60715 Plate or panel with fixing kit
Height	3.54 in (90 mm)
Depth	2.76 in (70 mm)
Width	4.33 in (110 mm)
Net Weight	0.87 lb(US) (0.395 kg)

Environment

Standards	EN/IEC 61010-2-201 EN/IEC 60664-1 EN/IEC 61131-2
Product Certifications	CSA LR ABS IACS E10 DNV-GL RCM CULus EAC
Environmental characteristic	Ordinary and hazardous location
Resistance to electrostatic discharge	8 KV in air EN/IEC 61000-4-2 4 kV on contact EN/IEC 61000-4-2
Resistance to electromagnetic fields	9.14 V/m (10 V/m) 80 MHz...1 GHz EN/IEC 61000-4-3 2.74 V/m (3 V/m) 1.4 GHz...2 GHz EN/IEC 61000-4-3 0.91 V/m (1 V/m) 2...2.7 GHz EN/IEC 61000-4-3
Resistance to magnetic fields	98.43 A/m (30 A/m) 50/60 Hz EN/IEC 61000-4-8
Resistance to fast transients	2 KV EN/IEC 61000-4-4 power lines) 2 KV EN/IEC 61000-4-4 relay output) 1 KV EN/IEC 61000-4-4 I/O) 1 KV EN/IEC 61000-4-4 Ethernet line) 1 kV EN/IEC 61000-4-4 serial link)
Surge withstand	2 KV power lines (AC) common mode EN/IEC 61000-4-5 2 KV relay output common mode EN/IEC 61000-4-5 1 KV I/O common mode EN/IEC 61000-4-5 1 KV shielded cable common mode EN/IEC 61000-4-5 0.5 KV power lines (DC) differential mode EN/IEC 61000-4-5 1 KV power lines (AC) differential mode EN/IEC 61000-4-5 1 KV relay output differential mode EN/IEC 61000-4-5 0.5 kV power lines (DC) common mode EN/IEC 61000-4-5
Resistance to conducted disturbances	10 V 0.15...80 MHz EN/IEC 61000-4-6 3 V 0.1...80 MHz Marine specification (LR, ABS, DNV, GL) 10 V spot frequency (2, 3, 4, 6.2, 8.2, 12.6, 16.5, 18.8, 22, 25 MHz) Marine specification (LR, ABS, DNV, GL)

Electromagnetic emission	Conducted emissions 79 dB μ V/m QP/66 dB μ V/m AV power lines (AC))0.15...0.5 MHz EN/IEC 55011 Conducted emissions 73 dB μ V/m QP/60 dB μ V/m AV power lines (AC))0.5...300 MHz EN/IEC 55011 Conducted emissions 120...69 dB μ V/m QP power lines)10...150 kHz EN/IEC 55011 Conducted emissions 63 dB μ V/m QP power lines)1.5...30 MHz EN/IEC 55011 Radiated emissions 40 dB μ V/m QP class A 10 m)30...230 MHz EN/IEC 55011 Conducted emissions 79...63 dB μ V/m QP power lines)150...1500 kHz EN/IEC 55011 Radiated emissions 47 dB μ V/m QP class A 10 m)200...1000 MHz EN/IEC 55011
Immunity to microbreaks	10 ms
Ambient air temperature for operation	14...131 °F (-10...55 °C) horizontal installation) 14...95 °F (-10...35 °C) vertical installation)
Ambient Air Temperature for Storage	-13...158 °F (-25...70 °C)
Relative humidity	10...95 %, without condensation in operation) 10...95 %, without condensation in storage)
IP degree of protection	IP20 with protective cover in place
Pollution degree	<= 2
Operating altitude	0...6561.68 ft (0...2000 m)
Storage altitude	0.00...9842.52 ft (0...3000 m)
Vibration resistance	3.5 mm 5...8.4 Hz symmetrical rail 3.5 mm 5...8.4 Hz panel mounting 1 gn 8.4...150 Hz symmetrical rail 1 gn 8.4...150 Hz panel mounting
Shock resistance	98 m/s ² 11 ms



Ordering and shipping details

Category	22533 - M2XX PLC & ACCESSORIES
Discount Schedule	MSX
GTIN	3606480648717
Nbr. of units in pkg.	1
Package weight(Lbs)	22.57 oz (640 g)
Returnability	Yes
Country of origin	TW

Packing Units

Unit Type of Package 1	PCE
Package 1 Height	4.38 in (11.116 cm)
Package 1 width	5.60 in (14.219 cm)
Package 1 Length	6.16 in (15.643 cm)
Unit Type of Package 2	CAR
Number of Units in Package 2	20
Package 2 Weight	30.58 lb(US) (13.87 kg)
Package 2 Height	11.46 in (29.1 cm)
Package 2 width	15.55 in (39.5 cm)
Package 2 Length	22.17 in (56.3 cm)

Offer Sustainability

Sustainable offer status	Green Premium product
California proposition 65	WARNING: This product can expose you to chemicals including: Lead and lead compounds, which is known to the State of California to cause cancer and birth defects or other reproductive harm. For more information go to www.P65Warnings.ca.gov
REACH Regulation	 REACH Declaration
EU RoHS Directive	Pro-active compliance (Product out of EU RoHS legal scope)  EU RoHS Declaration
Mercury free	Yes
RoHS exemption information	 Yes

China RoHS Regulation	China RoHS Declaration
Environmental Disclosure	Product Environmental Profile
Circularity Profile	End Of Life Information
WEEE	The product must be disposed on European Union markets following specific waste collection and never end up in rubbish bins.
PVC free	Yes

Dimensions

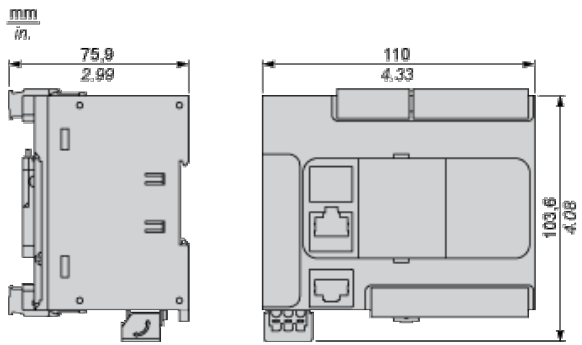

Mounting on a Rail

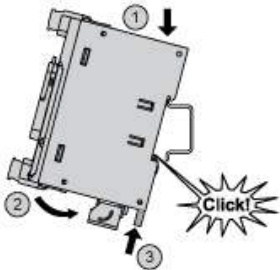

Direct Mounting on a Panel Surface

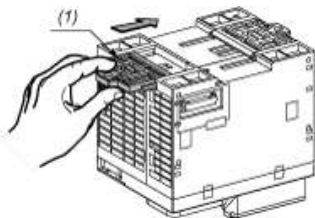

- (1) Install a mounting strip

Mounting Hole Layout

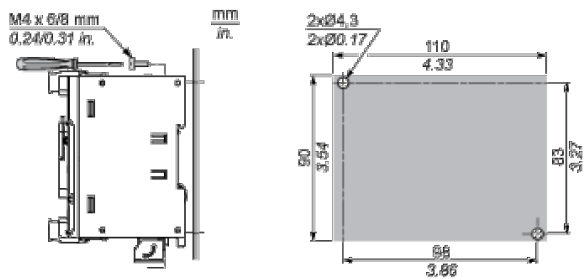

Mounting

Correct Mounting Position

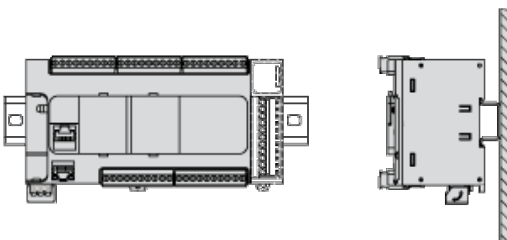

Acceptable Mounting Position

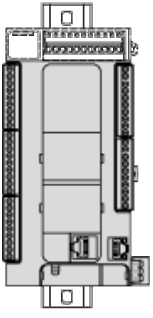

Incorrect Mounting Position

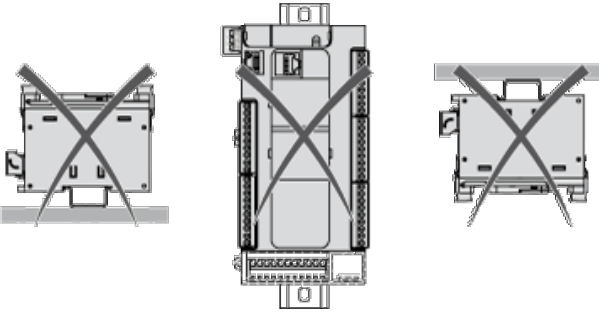

Clearance

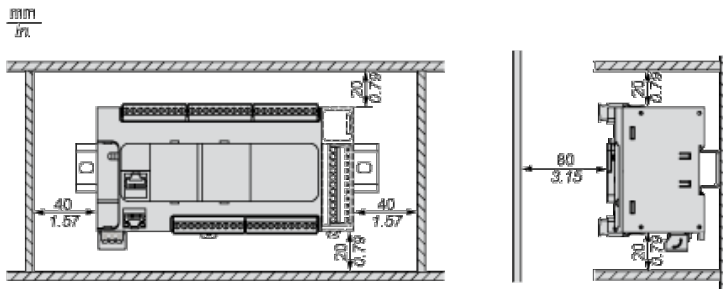

Digital Inputs

Wiring Diagram (Positive Logic)

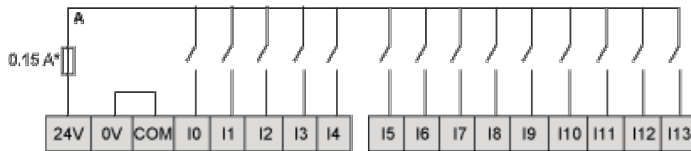

(*) Type T fuse

Wiring Diagram (Negative Logic)

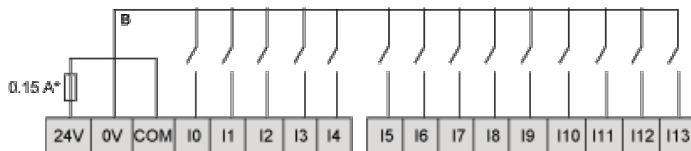

(*) Type T fuse

Connection of the Fast Inputs

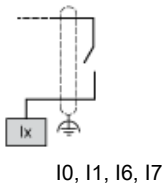

Relay Outputs

Negative Logic (Sink)

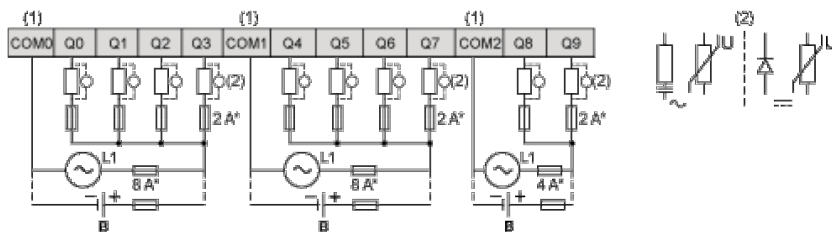

(*) Type T fuse

(1) The COM0, COM1 and COM2 terminals are not connected internally.

(2) To improve the life time of the contacts, and to protect from potential inductive load damage, you must connect a free wheeling diode in parallel to each inductive DC load or an RC snubber in parallel of each inductive AC load

B Sink wiring (negative logic)

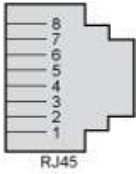

SL1

N °	RS 232	RS 485
1	RxD	N.C.
2	TxD	N.C.
3	RTS	N.C.
4	N.C.	D1
5	N.C.	D0
6	CTS	N.C.
7	N.C.*	5 Vdc
8	Common	Common

N.C.: not connected

* : 5 Vdc delivered by the controller. Do not connect.

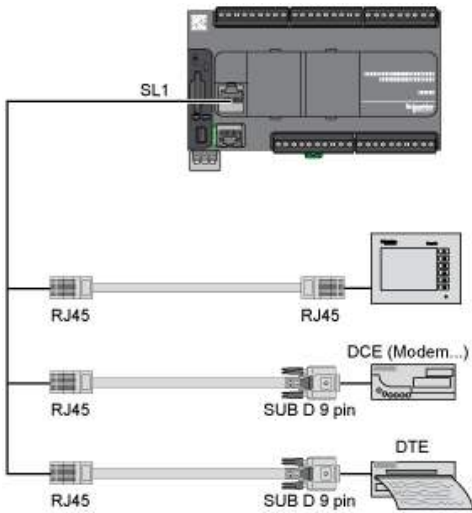

SL2 Connection

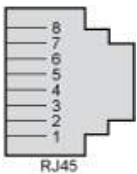

N °	RS 485
1	N.C.
2	N.C.
3	N.C.
4	D1
5	D0
6	N.C.
7	N.C.
8	Common

N.C.: not connected

Derating Curves

Embedded Digital Inputs (No Cartridge)

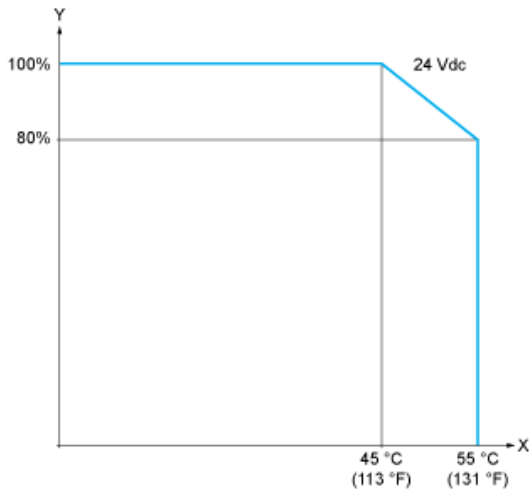

X : Ambient temperature
Y : Input simultaneous ON ratio

Embedded Digital Inputs (with Cartridge)

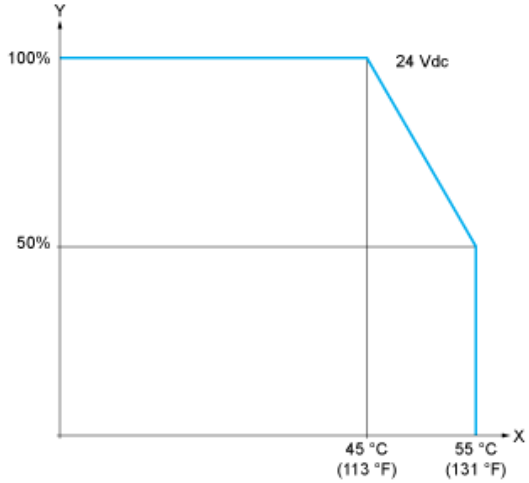

X : Ambient temperature
Y : Input simultaneous ON ratio