

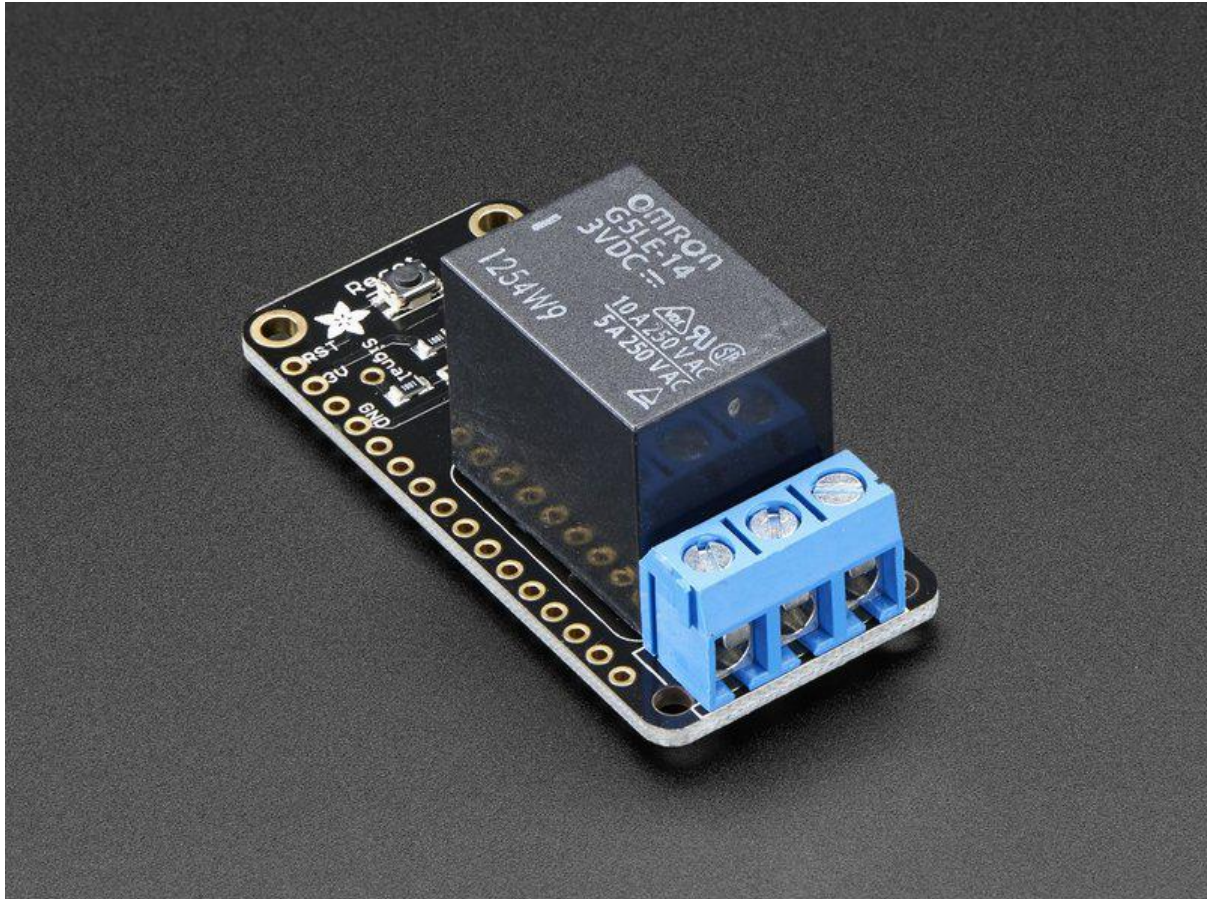

# Adafruit Power Relay FeatherWing

Created by lady ada



<https://learn.adafruit.com/adafruit-power-relay-featherwing>

Last updated on 2022-12-20 02:11:19 PM EST

# Table of Contents

[Overview](#) 3

---

[Pinouts](#) 5

---

- [Relay Control](#)
- [Relay Output](#)
- [Reset Button](#)

[Downloads](#) 7

---

- [Datasheets & Files](#)
- [Schematic and Fab Print for Revision B](#)
- [Schematic and Fab Print for Revision A](#)

---

# Overview



A Feather board without ambition is a Feather board without FeatherWings! This is the Power Relay FeatherWing. It gives you power to control, and control over power. Put simply, you can now turn on and off lamps, fans, solenoids, and other small appliances that run on up to 250VAC or DC power using any Feather board. [Compare to our smaller mini Relay FeatherWings \(\)](#), this one can handle a beefy 1200 Watts!

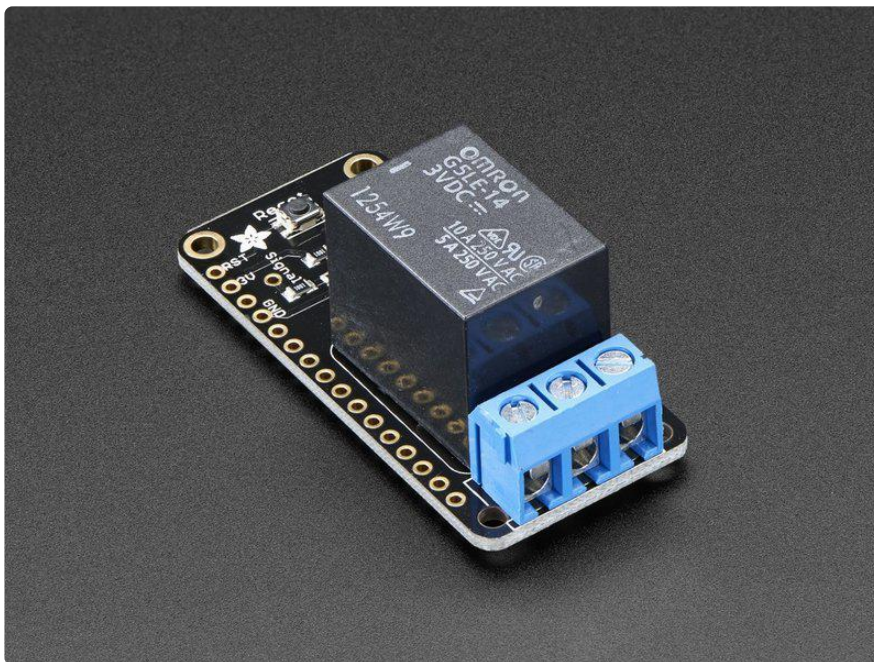

Using our [Feather Stacking Headers \(http://adafru.it/2830\)](http://adafru.it/2830) or [Feather Female Headers \(http://adafru.it/2886\)](http://adafru.it/2886) you can connect a FeatherWing on top of your Feather board and let the board take flight. [Check out our range of Feather boards here. \(\)](#)

This Wing has a non-latching type relay. You can switch up to 10A of resistive-load current at 120VAC, 5A at 240VAC. With inductive loads, about half that. Check the



datasheet for the relay for the exact switching capacity, as it depends on type of load and voltage type and magnitude. This relay is good for handling fairly large devices, computers, TVs, small appliances and more.

However, note that when closing the relay, it will draw 100mA continuously from the 3.3V power rail

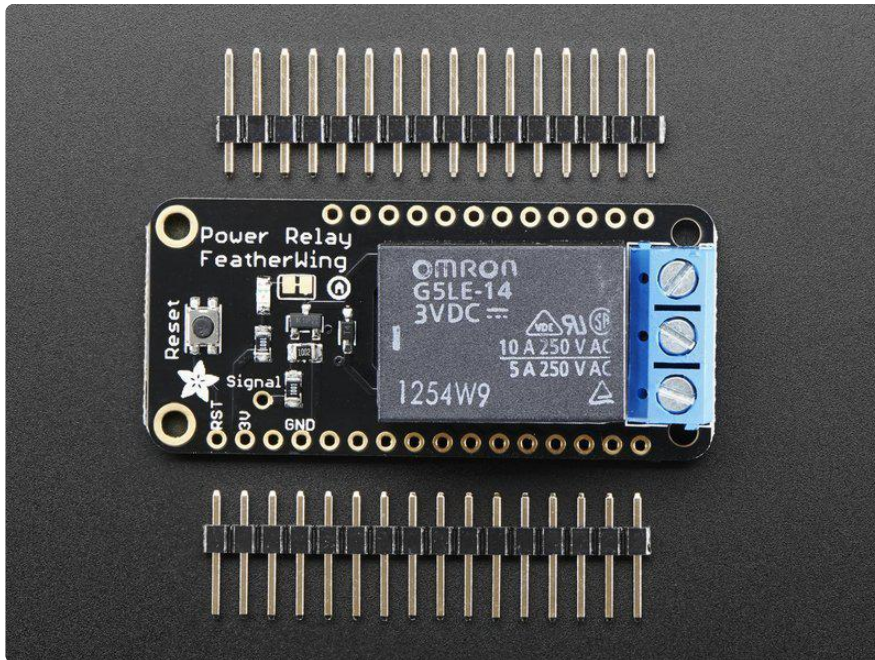

Each FeatherWing comes with a fully assembled and tested PCB, header you can use to attach to your Feather. By soldering closed the jumper on the underside of the Wing you can select which pin you want to use for the relay control. Some light soldering is required.

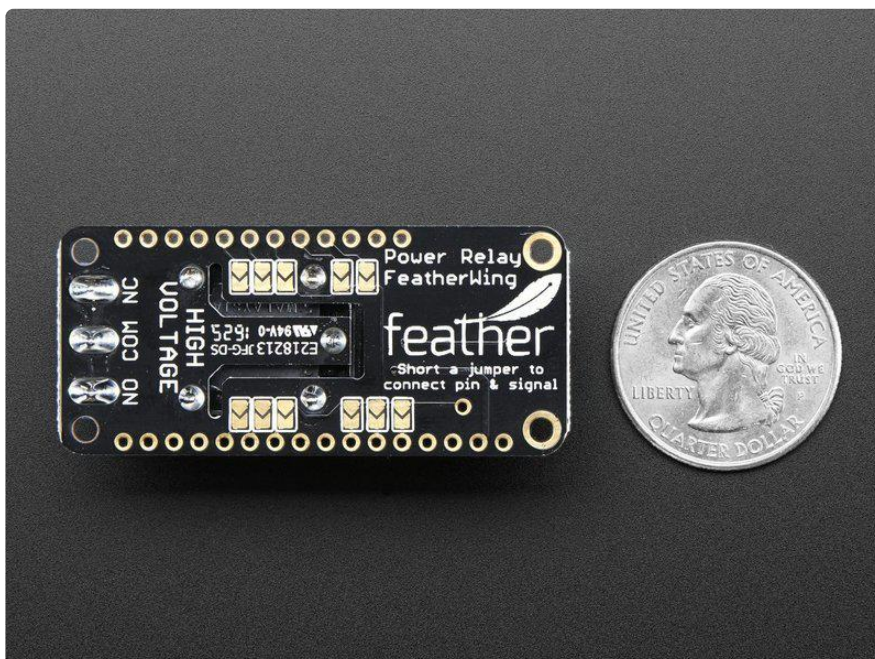

Please note: If using with high voltages (> 24V) use care and common sense! High voltages require experience, and are only for use by engineers who are comfortable with guidelines and know how to use them safely!

---

## Pinouts



## Relay Control

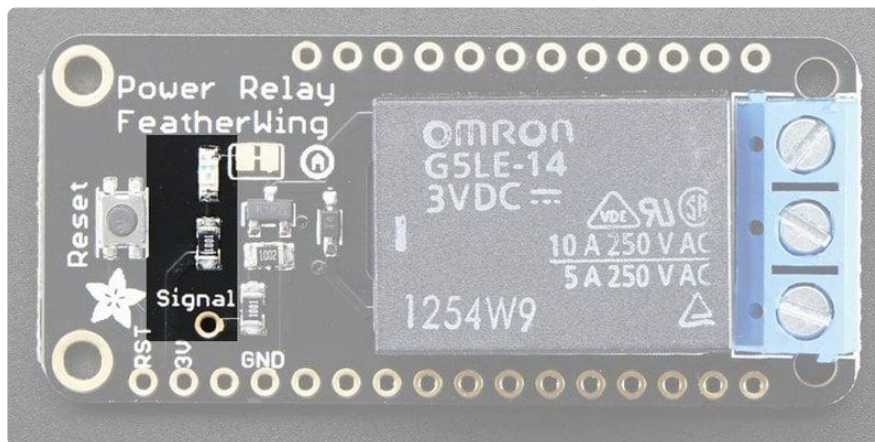

Controlling the relay is really simple. The relay uses a single pin for control. When floating or pulled low, the relay is 'open' or unset. When the pin is pulled high, the relay switches closed/set. A red LED next to the pin will let you know that the signal is high. You will need to solder closed a jumper on the bottom to match the pin you want to use for control.

When the relay is closed it will draw approximately 100 milliamps (yep! its a big relay and the voltage is only 3.3V) so keep that in mind when using a lot of accessories, sensors and devices on the 3.3V power line.



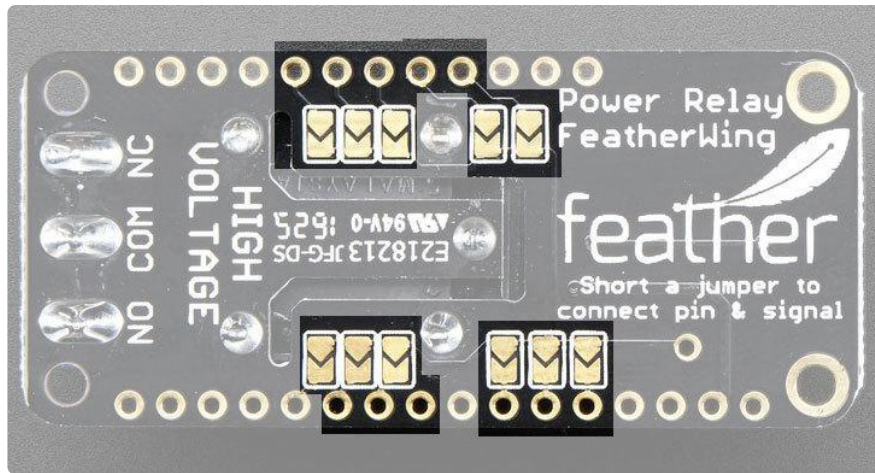

## Relay Output

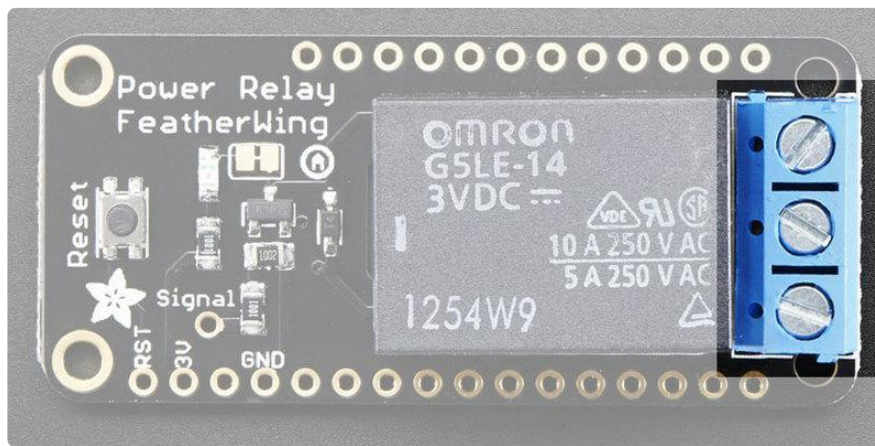

The Wing has the power control output on the end, a 3-pin 5.08 mm terminal block. The COM pin is what you should connect the signal you're planning to switch.

If the relay is unset, the NC pin (Normally Connected) is mechanically connected to COM. NO (Normally Open) is mechanically disconnected.

When the relay is set, NC becomes disconnected from COM and NO is connected to COM

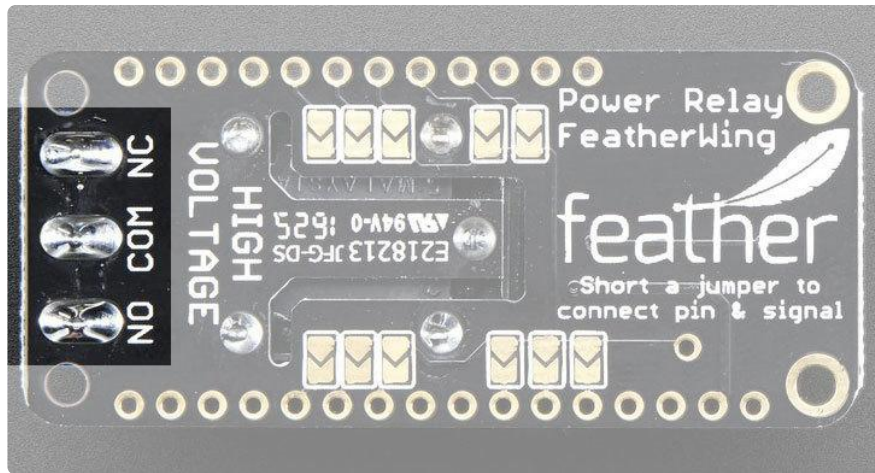

## Reset Button

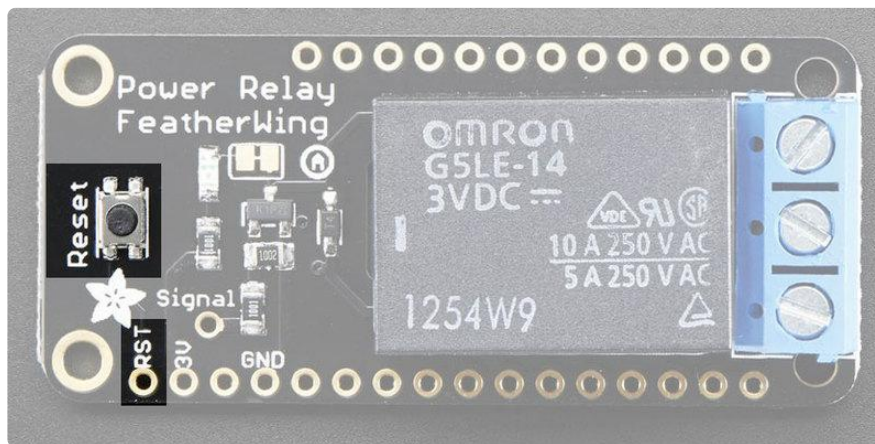

There is a Reset button on both Wings, this is connected to the RST pin and will short it to ground. It is not connected to the relay at all, its handy for restarting your Feather

---

## Downloads

## Datasheets & Files

- [EagleCAD PCB files on GitHub \(\)](#)
- [Fritzing object in Adafruit Fritzing library \(\)](#)
- [Datasheet for the Relay \(\)](#)

# Schematic and Fab Print for Revision B

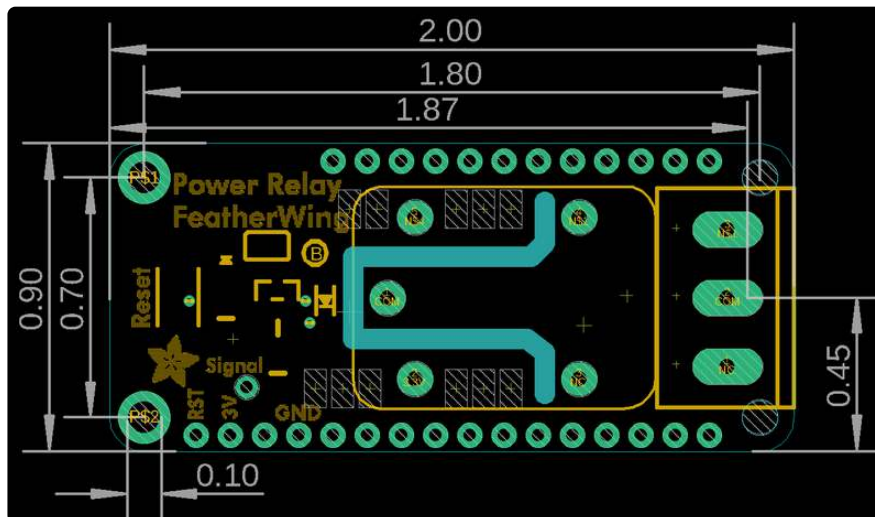
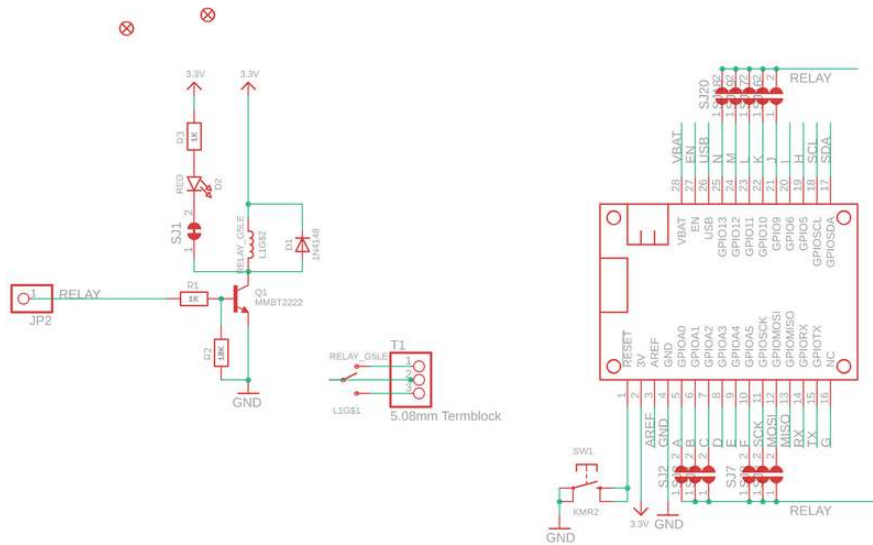

# Schematic and Fab Print for Revision A

