



Dimension			
L	*	W	* H
295	*	127	* 41 (1U) mm
11.6	*	5	* 1.61(1U) inch



■ Features

- Universal AC input / Full range (Withstand 300VAC surge input for 5 seconds)
- Built-in active PFC function
- High efficiency up to 92%
- Forced air cooling by built-in DC fan
- Output voltage programmable
- Built-in OR-ing FET, support hot swap (hot plug)
- Active current sharing up to 6000W for one 19" rack shelf
- Built-in I²C interface, PMBus protocol
- Protections: Short circuit / Overload / Over voltage / Over temperature
- Optional conformal coating
- 5 years warranty

■ Applications

- Industrial automation
- Distributed power architecture system
- Wireless/telecommunication solution
- Redundant power system
- Electric vehicle charger system
- Constant current source system

■ GTIN CODE

MW Search: <https://www.meanwell.com/serviceGTIN.aspx>

■ Description

RCP-2000 is a 2KW single output rack mountable front end AC/DC power supply with a 1U low profile and a high power density up to 25W/inch³. This series operates for 90~264VAC input voltage and offers the models with the DC output mostly demanded from the industry. Each model is cooled by the built-in DC fan with fan speed control, working for the temperature up to 70°C. RCP-2000 provides vast design flexibility by equipping various built-in functions such as the PMBus communication protocol, output programming, active current sharing (up to 18000W via three 19" rack shelves, RKP-1U), remote control, auxiliary power, alarm signal, external control/monitor via the control model RKP-CMU1, etc. Maximum number that can be monitored by master controller in communication shall be 9 power supplies.

■ Model Encoding / Order Information

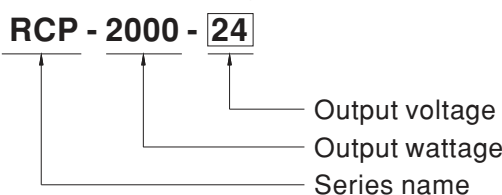

- ※ Note 1: 19" rack shelf, RKP-1U, available. Details available on <http://www.meanwell.com/>
- ※ Note 2: Control/Monitor unit, RKP-CMU1, available. Details available on <http://www.meanwell.com/>

SPECIFICATION

MODEL		RCP-2000-12	RCP-2000-24	RCP-2000-48	
OUTPUT	DC VOLTAGE	12V	24V	48V	
	RATED CURRENT	100A	80A	42A	
	CURRENT RANGE	0 ~ 100A	0 ~ 80A	0 ~ 42A	
	RATED POWER	1200W	1920W	2016W	
	RIPPLE & NOISE (max.) <small>Note.2</small>	150mVp-p	200mVp-p	300mVp-p	
	VOLTAGE ADJ. RANGE	10.5 ~ 14V	21 ~ 28V	42 ~ 56V	
	VOLTAGE TOLERANCE <small>Note.4</small>	±2.0%	±1.0%	±1.0%	
	LINE REGULATION	±1.0%	±0.5%	±0.5%	
	LOAD REGULATION	±1.0%	±0.5%	±0.5%	
	SETUP, RISE TIME	1500ms, 60ms/230VAC at full load			
HOLD UP TIME (Typ.)	16ms/230VAC at 75% load 10ms/230VAC at full load				
INPUT	VOLTAGE RANGE <small>Note.5,6</small>	90 ~ 264VAC 250 ~ 320VDC			
	FREQUENCY RANGE	47 ~ 63Hz			
	POWER FACTOR (Typ.)	0.98/230VAC at full load			
	EFFICIENCY (Typ.)	86%	90.5%	92%	
	AC CURRENT (Typ.)	13A/115VAC 7A/230VAC	16A/115VAC 10A/230VAC	16A/115VAC 10A/230VAC	
	INRUSH CURRENT (Typ.)	COLD START 50A			
	LEAKAGE CURRENT	<1.1mA / 230VAC			
PROTECTION	OVERLOAD	105 ~ 125% rated output power Protection type : Constant current limiting, unit will shut down o/p voltage after 5 sec. re-power on to recover			
	OVER VOLTAGE	14.7 ~ 17.5V	29.5 ~ 35V	57.6 ~ 67.2V	
	OVER TEMPERATURE	Shut down o/p voltage, recovers automatically after temperature goes down			
FUNCTION	AUXILIARY POWER	5V @ 0.3A, 12V @ 0.8A			
	REMOTE ON-OFF CONTROL	Please refer to the Function Manual			
	REMOTE SENSE	Compensate voltage drop on the load wiring up to 0.5V			
	OUTPUT VOLTAGE PROGRAMMABLE	Adjustment of output voltage is allowable to 90 ~ 110% of nominal output voltage. Please refer to the Function Manual.			
	DC OK SIGNAL	The isolated TTL signal out, Please refer to the Installation Manual			
	AC OK SIGNAL	The isolated TTL signal out, Please refer to the Installation Manual			
	OVER TEMP WARNING	Logic " High" for over temperature warning, Please refer to the Installation Manual, isolated signal			
	FAN FAIL SIGNAL	The isolated TTL signal out, Please refer to the Installation Manual			
ENVIRONMENT	WORKING TEMP.	-35 ~ +70°C (Refer to "Derating Curve")			
	WORKING HUMIDITY	20 ~ 90% RH non-condensing			
	STORAGE TEMP., HUMIDITY	-40 ~ +85°C, 10 ~ 95% RH non-condensing			
	TEMP. COEFFICIENT	±0.03%/°C (0 ~ 50°C)			
	VIBRATION	10 ~ 500Hz, 2G 10min./1cycle, 60min. each along X, Y, Z axes			
SAFETY & EMC (Note 7)	SAFETY STANDARDS	UL62368-1, CSA C22.2 No. 62368-1, TUV BS EN/EN62368-1, EAC TP TC 004 approved			
	WITHSTAND VOLTAGE	I/P-O/P:3KVAC I/P-FG:2KVAC O/P-FG:0.7KVDC			
	ISOLATION RESISTANCE	I/P-O/P, I/P-FG, O/P-FG:100M Ohms / 500VDC / 25°C / 70% RH			
	EMC EMISSION	Parameter	Standard	Test Level / Note	
		Conducted	BS EN/EN55032 (CISPR32)	Class B	
		Radiated	BS EN/EN55032 (CISPR32)	Class A	
		Harmonic Current	BS EN/EN61000-3-2	-----	
	Voltage Flicker	BS EN/EN61000-3-3	-----		
	EMC IMMUNITY	BS EN/EN55035, BS EN/EN61000-6-2			
		Parameter	Standard	Test Level / Note	
		ESD	BS EN/EN61000-4-2	Level 3, 8KV air ; Level 2, 4KV contact	
		Radiated	BS EN/EN61000-4-3	Level 3	
		EFT / Burst	BS EN/EN61000-4-4	Level 3	
Surge		BS EN/EN61000-4-5	Level 4, 4KV/Line-Earth ; Level 3, 2KV/Line-Line		
Conducted		BS EN/EN61000-4-6	Level 3		
Magnetic Field		BS EN/EN61000-4-8	Level 4		
Voltage Dips and Interruptions	BS EN/EN61000-4-11	>95% dip 0.5 periods, 30% dip 25 periods, >95% interruptions 250 periods			
OTHERS	MTBF	444.9K hrs min. Telcordia SR-332 (Bellcore) ; 37.4K hrs min. MIL-HDBK-217F (25°C)			
	DIMENSION	295*127*41mm (L*W*H)			
	PACKING	2Kg; 6pcs/13Kg/1.04CUFT			
NOTE	<ol style="list-style-type: none"> All parameters NOT specially mentioned are measured at 230VAC input, rated load and 25°C of ambient temperature. Ripple & noise are measured at 20MHz of bandwidth by using a 12" twisted pair-wire terminated with a 0.1uf & 47uf parallel capacitor. Under parallel operation of more than one rack connecting together, ripple of the output voltage may be higher than the SPEC at light load condition. It will go back to normal ripple level once the output load is more than 10%. Tolerance : includes set up tolerance, line regulation and load regulation. Derating may be needed under low input voltages. Please check the static characteristics for more details. Please contact MEANWELL for 320~370VDC application. The power supply is considered a component which will be installed into a final equipment. All the EMC tests are been executed by mounting the unit on a 720mm*360mm metal plate with 1mm of thickness. The final equipment must be re-confirmed that it still meets EMC directives. For guidance on how to perform these EMC tests, please refer to "EMI testing of component power supplies." (as available on http://www.meanwell.com) The ambient temperature derating of 3.5°C/1000m with fanless models and of 5°C/1000m with fan models for operating altitude higher than 2000m(6500ft). <p>※ Product Liability Disclaimer : For detailed information, please refer to https://www.meanwell.com/serviceDisclaimer.aspx</p>				

Block Diagram

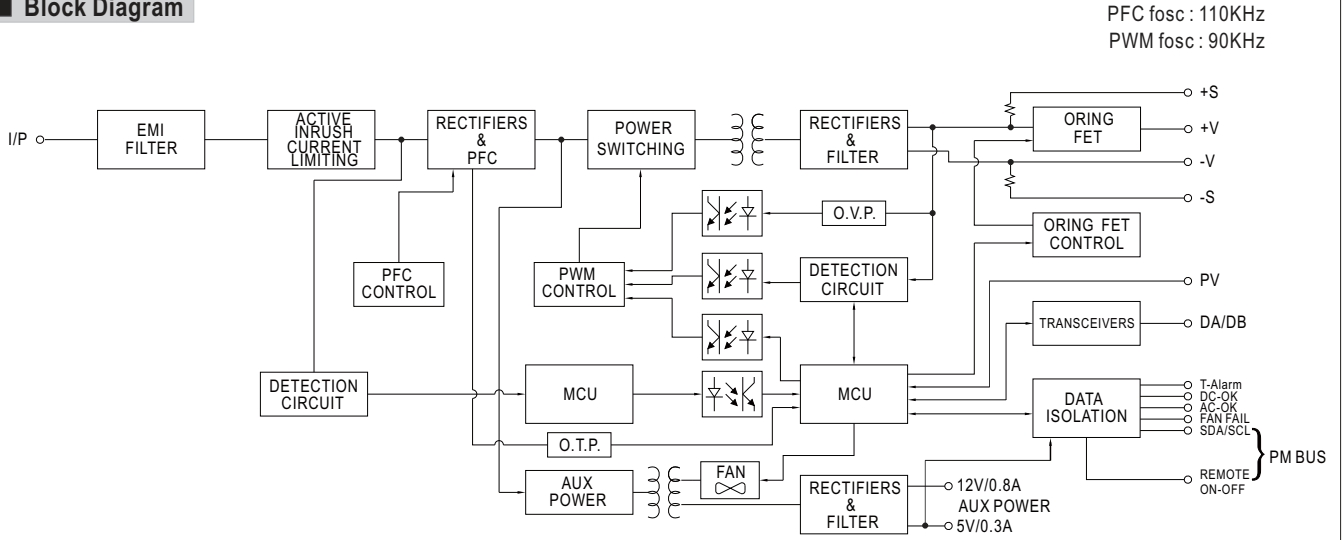

Static Characteristics

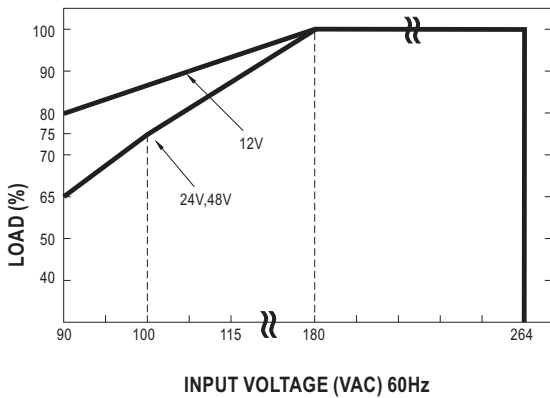

Derating Loads vs Input Voltage

INPUT \ MODEL	12V	24V	48V
180~264VAC	1200W 100A	1920W 80A	2016W 42A
115VAC	1080W 90A	1632W 68A	1713.6W 35.7A
100VAC	1020W 85A	1440W 60A	1512W 31.5A
90VAC	960W 80A	1248W 52A	1310.4W 27.3A

Derating Curve

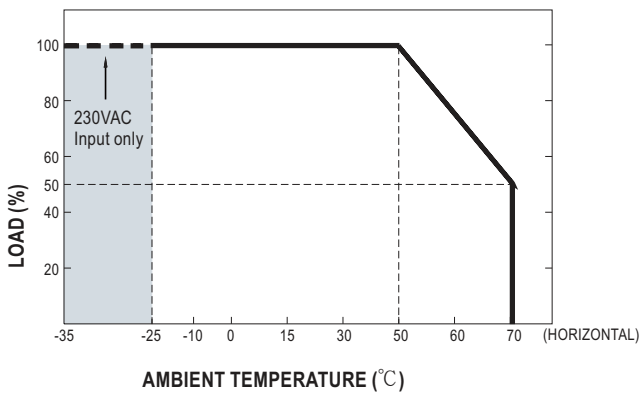

Efficiency vs Load (48V Model)

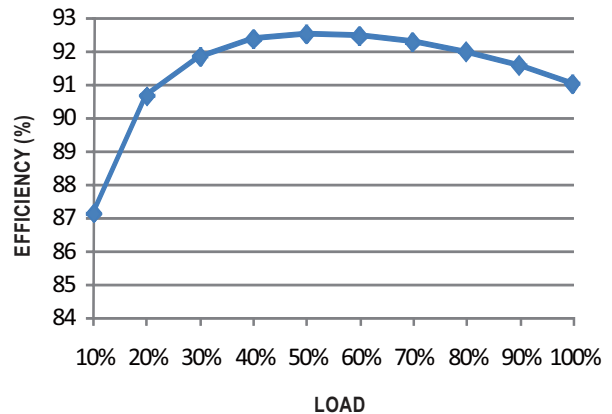

© The curve above is measured at 230VAC.

Function Manual

1. Voltage Drop Compensation

1.1 Remote Sense

※ The Remote Sense compensates voltage drop on the load wiring up to 0.5V

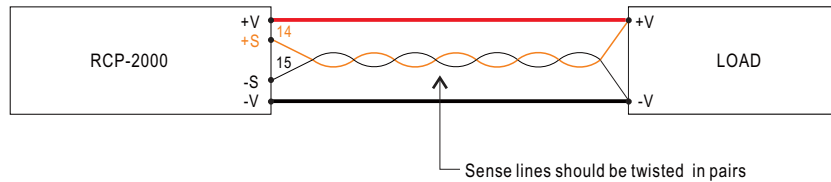

1.2 Local Sense

※ The +S, -S have to be connected to the +V(signal), -V(signal), respectively, as the following diagram, in order to get the correct output voltage if Remote Sense is not used.

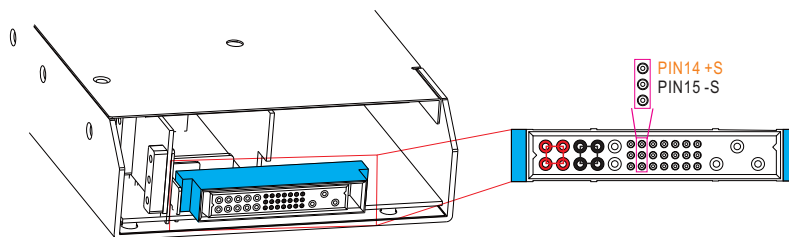

2. Output Voltage Programming (or, PV / remote voltage programming / remote adjust / margin programming / dynamic voltage trim)

※ In addition to the adjustment via the built-in potentiometer, the output voltage can be trimmed to 90~110% of the nominal voltage by applying EXTERNAL VOLTAGE.

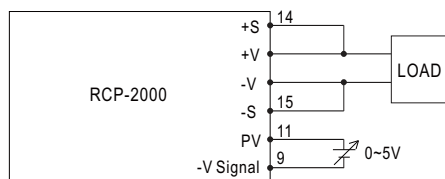

◎ +S & +V, -S & -V also need to be connected on CN501

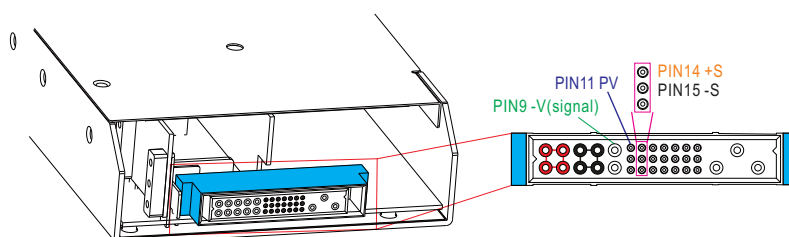
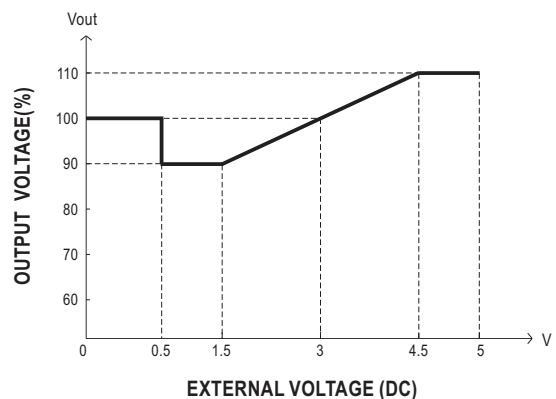

3. Remote ON-OFF Control

The power supply can be turned ON/OFF together or separately by using the "Remote ON/OFF" function.

Between <i>Remote ON-OFF</i> and <i>+5V-AUX</i>	Power Supply Status
Switch Short	ON
Switch Open	OFF

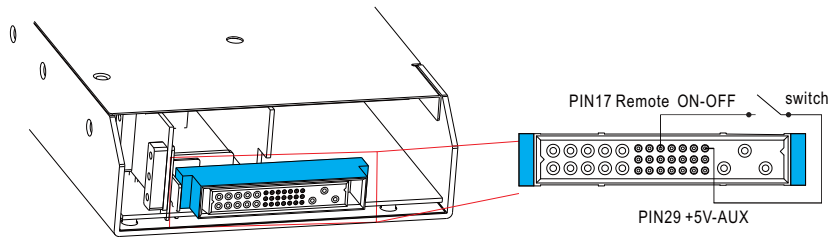

4.PMBus Communication Interface

※ RCP-2000 supports PMBus Rev. 1.1 with maximum 100KHz bus speed, allowing information reading, status monitoring and output trimming. For details, please refer to the Installation Manual.

■ Mechanical Specification

Case No. 974A Unit:mm

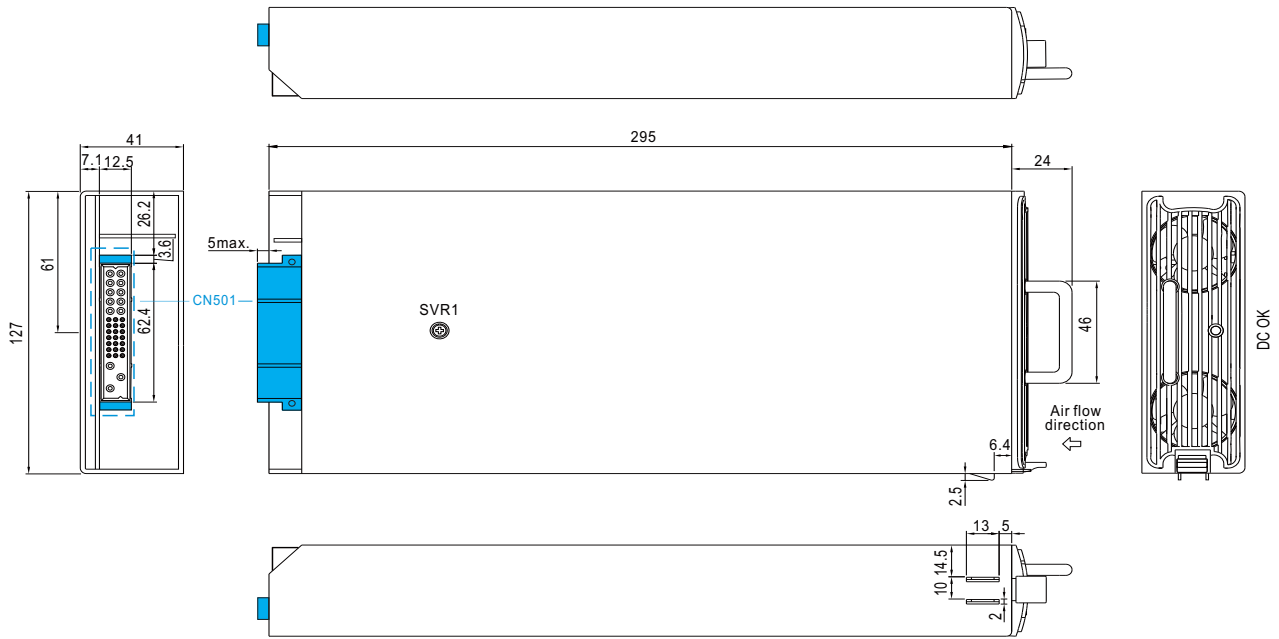

※ LED Status Indicators & Corresponding Signal at Function Pins

Function	LED	Description	* Signal	Power Supply
AC-OK	GREEN	When input voltage $\geq 87V$	0 ~ 0.5V	ON
AC-NG	RED	When input voltage $\leq 75V$	4.5 ~ 5.5V	OFF
DC-OK	GREEN	When output voltage $\geq 80\% \pm 5\%$ of V_o rated.	0 ~ 0.5V	ON
DC-NG	RED	When output voltage $\leq 80\% \pm 5\%$ of V_o rated.	4.5 ~ 5.5V	ON
T-OK	GREEN	When the internal temperature (TSW1 & TSW2 short) is within safe limit	0 ~ 0.5V	ON
T-ALARM	RED	When the internal temperature (TSW1 or TSW2 open) exceeds the limit of temperature alarm	4.5 ~ 5.5V	OFF

*Signal between function pin and "GND-AUX".

※ Input / Output Connector Pin No. Assignment(CN501) : Positronic PCIM34W13M400A1

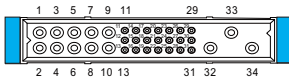

Mating Housing Positronic PCIM34W13F400A1

Pin No.	Function	Description
1,2,3,4	+V	Positive output terminal.
5,6,7,8	-V	Negative output terminal.
9	-V(Signal)	Negative output voltage signal. For local sense only ; it cannot be connected directly to the load.
10	+V(Signal)	Positive output voltage signal. For local sense only ; it cannot be connected directly to the load.
11	PV	Connection for output voltage programming. (Note.1)
12,13	DA,DB	Differential digital signal for parallel control. (Note.1)
14	+S	Positive sensing for remote sense.
15	-S	Negative sensing for remote sense.
16,18,19,20,21	A0,A1,A2,A3,A4	PMBus interface address lines. (Note.1)
17	Remote ON-OFF	The unit can turn the output on and off by electrical signal or dry contact between <i>Remote ON-OFF</i> and +5V-AUX. (Note.2) Short (4.5 ~ 5.5V) : Power ON ; Open (0 ~ 0.5V) : Power OFF ; The maximum input voltage is 5.5V.
22	NC	Retain for future use.
23	SDA	Serial Data used in the PMBus interface. (Note.2)
24	SCL	Serial Clock used in the PMBus interface. (Note.2)
25	AC-OK	Low (0 ~ 0.5V) : When the input voltage is $\geq 87V_{rms}$. High (4.5 ~ 5.5V) : When the input voltage in $\leq 75V_{rms}$. The maximum sourcing current is 10mA and only for output. (Note.2)
26	DC-OK	High (4.5 ~ 5.5V) : When the $V_{out} \leq 80\% \pm 5\%$. Low (0 ~ 0.5V) : When $V_{out} \geq 80\% \pm 5\%$. The maximum sourcing current is 10mA and only for output. (Note.2)
27	T-ALARM	High (4.5 ~ 5.5V) : When the internal temperature (TSW1 or TSW2 open) exceeds the limit of temperature alarm. Low (0 ~ 0.5V) : When the internal temperature (TSW1 or TSW2 short) under the limit temperature. The maximum sourcing current is 10mA and only for output(Note.2)
28	FAN-FAIL	High (4.5 ~ 5.5V) : When the internal fan fail. Low (0 ~ 0.5V) : When the internal fan is normal. The maximum sourcing current is 10mA and only for output(Note.2)
29	+5V-AUX	Auxiliary voltage output, 4.5~5.5V, referenced to GND-AUX (pin 31). The maximum load current is 0.3A. This output has the built-in "Oring diodes" and is not controlled by the remote ON/OFF control.
30	+12V-AUX	Auxiliary voltage output, 10.8~13.2V, referenced to GND-AUX (pin 31). The maximum load current is 0.8A. This output has the built-in "Oring diodes" and is not controlled by the remote ON/OFF control.
31	GND-AUX	Auxiliary voltage output GND. The signal return is isolated from the output terminals (+V & -V).
32	FG	AC Ground connection.
33	AC/L	AC Line connection.
34	AC/N	AC Neutral connection.

Note1: Non-isolated signal, referenced to -V(signal).

Note2: Isolated signal, referenced to GND-AUX.