

## QUAD OPERATIONAL AMPLIFIER

### ■ GENERAL DESCRIPTION

The NJM2058 integrated circuit is a quad high-gain operational amplifier internally compensated and constructed on a single silicon chip using an advanced epitaxial process.

Each amplifier of the NJM2058 has the same electrical characteristics of the NJM4558.

### ■ FEATURES

- Operating Voltage (  $\pm 4V \sim \pm 18V$  )
- Package Outline DIP14,DMP14,SSOP14
- Bipolar Technology

### ■ PIN CONFIGURATION

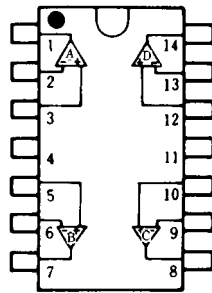

NJM2058D  
NJM2058M  
NJM2058V

### ■ PACKAGE OUTLINE

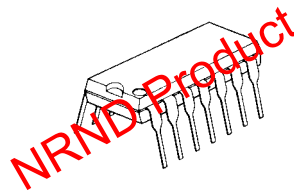

NJM2058D

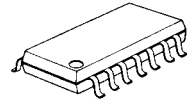

NJM2058M

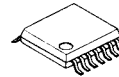

NJM2058V

### PIN FUNCTION

1. A OUTPUT
2. A -INPUT
3. A +INPUT
4.  $V^+$
5. B +INPUT
6. B -INPUT
7. B OUTPUT
8. C OUTPUT
9. C -INPUT
10. C +INPUT
11.  $V^-$
12. D +INPUT
13. D -INPUT
14. D OUTPUT

### ■ EQUIVALENT CIRCUIT ( 1/4 Shown )

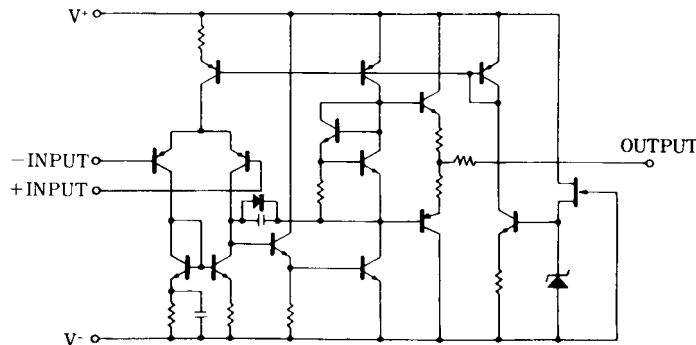

## ■ ABSOLUTE MAXIMUM RATINGS

( Ta=25°C )

PARAMETER	SYMBOL	RATINGS	UNIT
Supply Voltage	$V^+ / V^-$	± 18	V
Differential Input Voltage	$V_{ID}$	± 30	V
Input Voltage	$V_{IC}$	± 15 ( note1 )	V
Power Dissipation	$P_D$	( DIP14 ) 700 ( DMP14 ) 700 ( note2 ) ( SSOP14 ) 300	mW
Operating Temperature Range	$T_{opr}$	-40~+85	°C
Storage Temperature Range	$T_{stg}$	-40~+125	°C

( note1 ) For supply voltage less than ±15V. the absolute maximum input voltage is equal to the supply voltage.

( note2 ) At on PC board

## ■ ELECTRICAL CHARACTERISTICS

( Ta=25°C,  $V^+ / V^- = \pm 15V$  )

PARAMETER	SYMBOL	TEST CONDITION	MIN.	TYP.	MAX.	UNIT
Input Offset Voltage	$V_{IO}$	$R_S \leq 10k\Omega$	-	0.5	6	mV
Input Offset Current	$I_{IO}$		-	5	200	nA
Input Bias Current	$I_B$		-	20	500	nA
Input Resistance	$R_{IN}$		0.3	1	-	MΩ
Large signal Voltage Gain	$A_V$	$R_L \geq 2k\Omega, V_O = \pm 10V$	86	100	-	dB
Maximum Output Voltage Swing 1	$V_{OM1}$	$R_L \geq 10k\Omega$	± 12	± 14	-	V
Maximum Output Voltage Swing 2	$V_{OM2}$	$R_L \geq 2k\Omega$	± 10	± 13	-	V
Input Common Mode Voltage Range	$V_{ICM}$		± 12	± 14	-	V
Common Mode Rejection Ratio	CMR	$R_S \leq 10k\Omega$	70	90	-	dB
Supply Voltage Rejection Ratio	SVR	$R_S \leq 10k\Omega$	76.5	90	-	dB
Operating Current	$I_{CC}$		-	7	11.3	mA
Slew Rate	SR		-	1	-	V/μs
Equivalent Input Noise Voltage	$V_{NI}$	RIAA, $R_S = 2.2k\Omega, 30kHz$ LPF	-	1.4	-	μVrms

■ TYPICAL CHARACTERISTICS

**Equivalent Input Noise Voltage vs. Frequency**

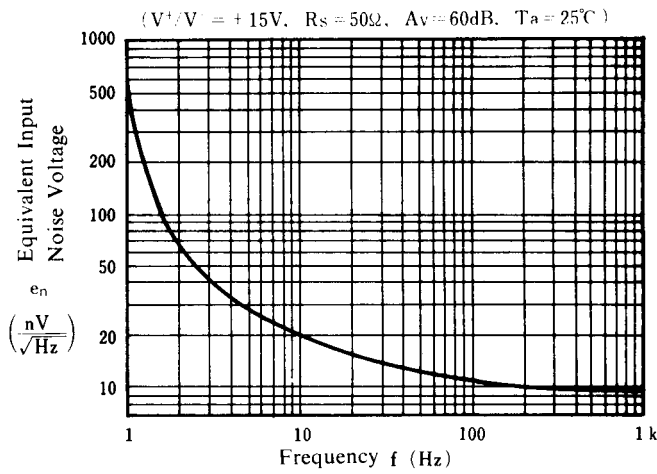

**Open Loop Voltage Gain vs. Frequency**

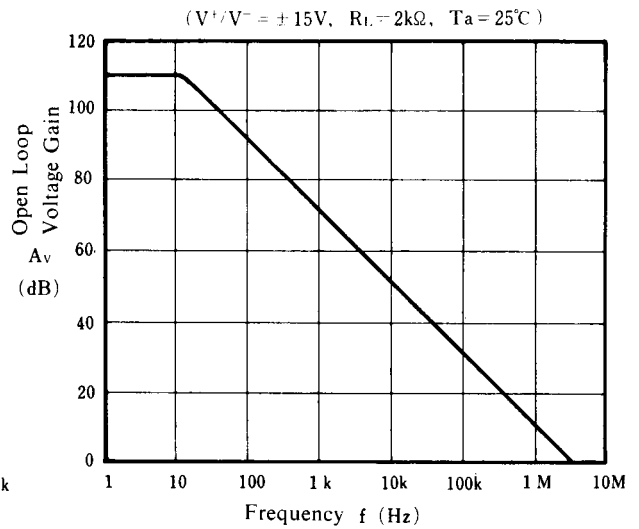

**Maximum Output Voltage Swing vs. Frequency**

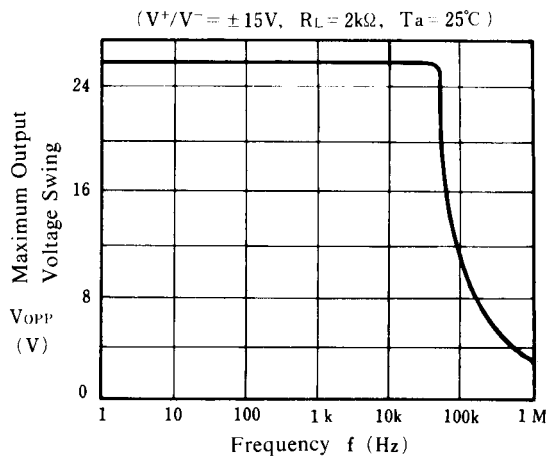

**Maximum Output Voltage Swing vs. Load Resistance**

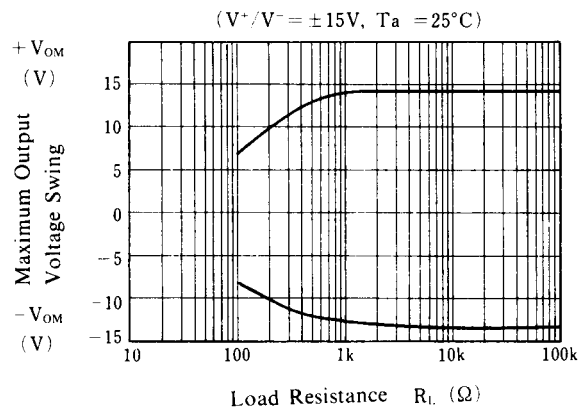

**Operating Current vs. Temperature**

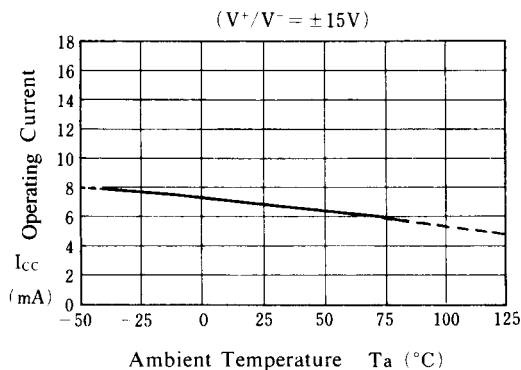

**Maximum Output Voltage Swing vs. Temperature**

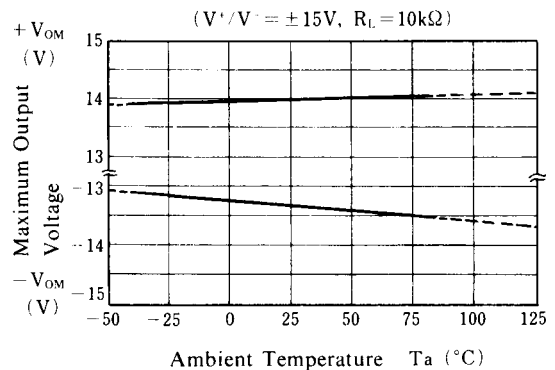

■ TYPICAL CHARACTERISTICS

**Input Offset Voltage vs. Temperature**

( $V^+/V^- = \pm 15V$ )

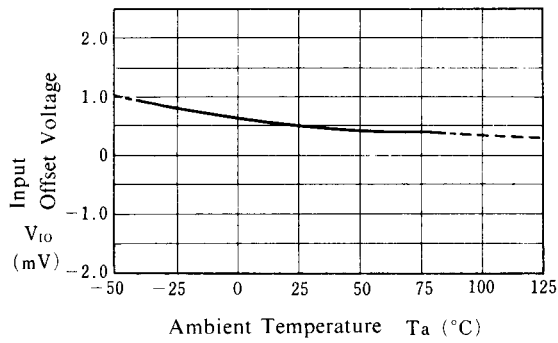

**Input Bias Current vs. Temperature**

( $V^+/V^- = \pm 15V$ )

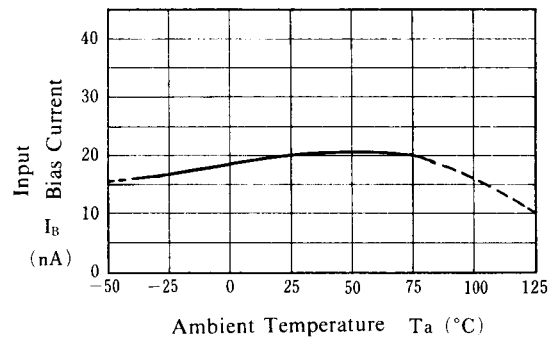

**Operating Current vs. Operating Voltage**

( $T_a = 25^\circ C$ )

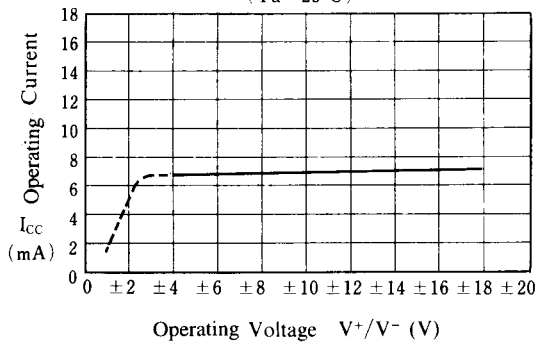

**Maximum Output Voltage Swing vs. Operating Voltage**

( $R_L = 2k\Omega, T_a = 25^\circ C$ )

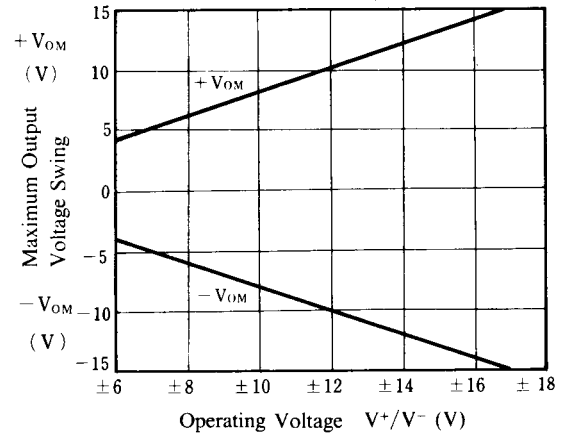

■ TYPICAL CHARACTERISTICS

**Total Harmonic Distortion**

( $V^+/V^- = \pm 15V$ , Gain=40dB,  $R_L = 10k\Omega$ ,  
 $T_a = 25^\circ C$ )

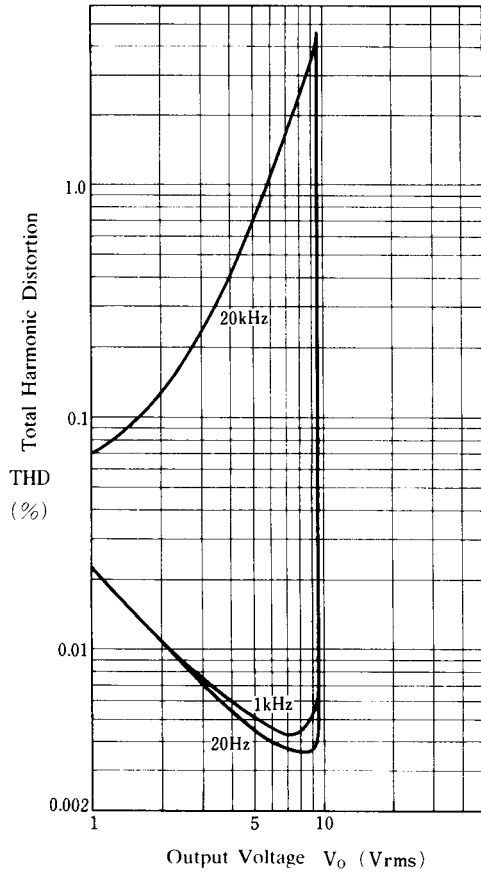

**Total Harmonic Distortion**

( $V^+/V^- = \pm 15V$ , Gain=40dB,  $R_L = 2k\Omega$ ,  
 $T_a = 25^\circ C$ )

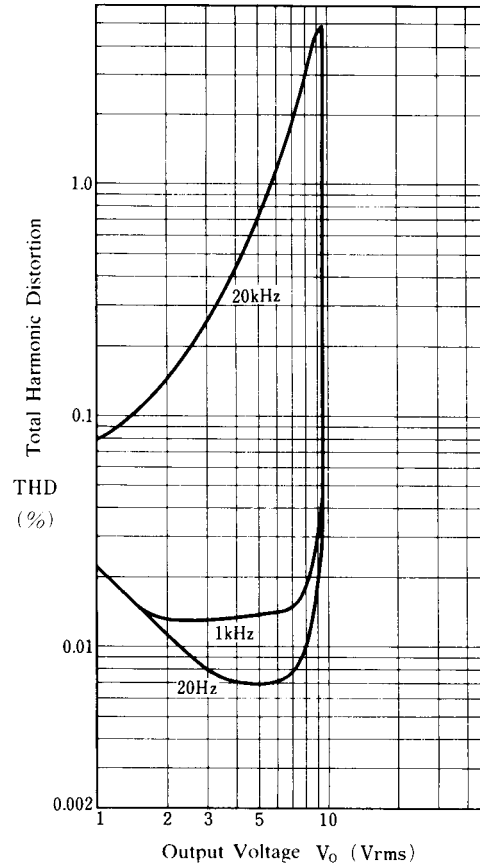

[CAUTION]  
 The specifications on this databook are only given for information, without any guarantee as regards either mistakes or omissions. The application circuits in this databook are described only to show representative usages of the product and not intended for the guarantee or permission of any right including the industrial rights.