

Maswell 5G High Gain Ultra Wideband Log Periodic Antenna

AN_Master_005 MIMO

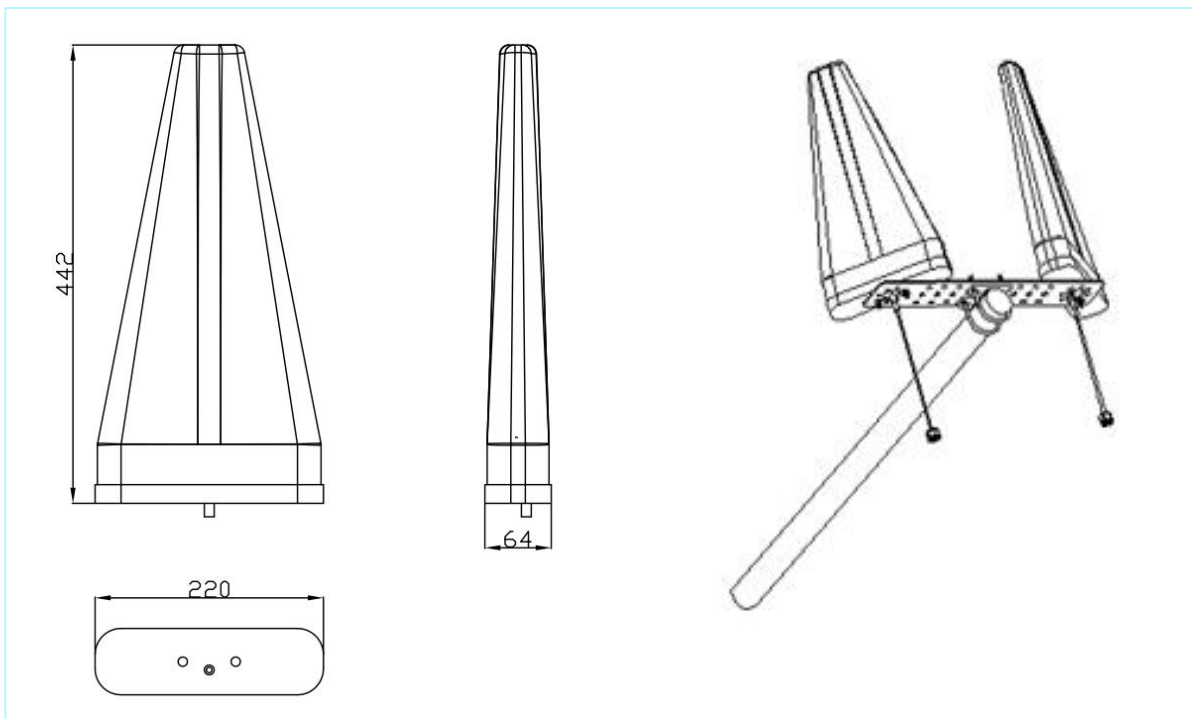

Mechanical dimension



Maswell 5G High Gain Ultra Wideband Log Periodic Antenna

AN_Master_005 MIMO

Specifications

Item	Specifications	
Antenna*2	Center Frequency	600~6000 MHz
	Polarization	Linear
	Gain	9.50dBi (Zenith)
	V.S.W.R	<2.0
	Impedance	50Ω
	Mounting Method	U bolt
	Cable	Ultra Low loss cable 4 meters (LMR 600 equivalent)
	Connector	Both SMA male and N male supported
	Dimension	442* 220*64mm
Installation Kit	U bolt Dimension	450*90*20mm
Environmental	Operating Temperature	-40°C~+85°C
	Vibration	10 to 55Hz with 1.5mm amplitude 2hours
	Environmentally Friendly	ROHS Compliant

Maswell 5G High Gain Ultra Wideband Log Periodic Antenna

Product Configuration in Details



- ❖ **The AN_Master_005 MIMO comes with two AN_Master_005 and an Installation Kit, and the AN_Master_005 comes with two boxes:**
- ❖ **Box One: AN_Master_005 MIMO with 10cm cable and N male connector**
- ❖ **Box Two: One unit of Ultra low loss 0.6 inch cable (LMR 600 equivalent) with N female to N male connector
One Unit of Interface cable 10cm N female to SMA male**

No need to worry about the high cable loss above 5GHz!

Maswell 5G High Gain Ultra Wideband Log Periodic Antenna

Simulation Results

S11

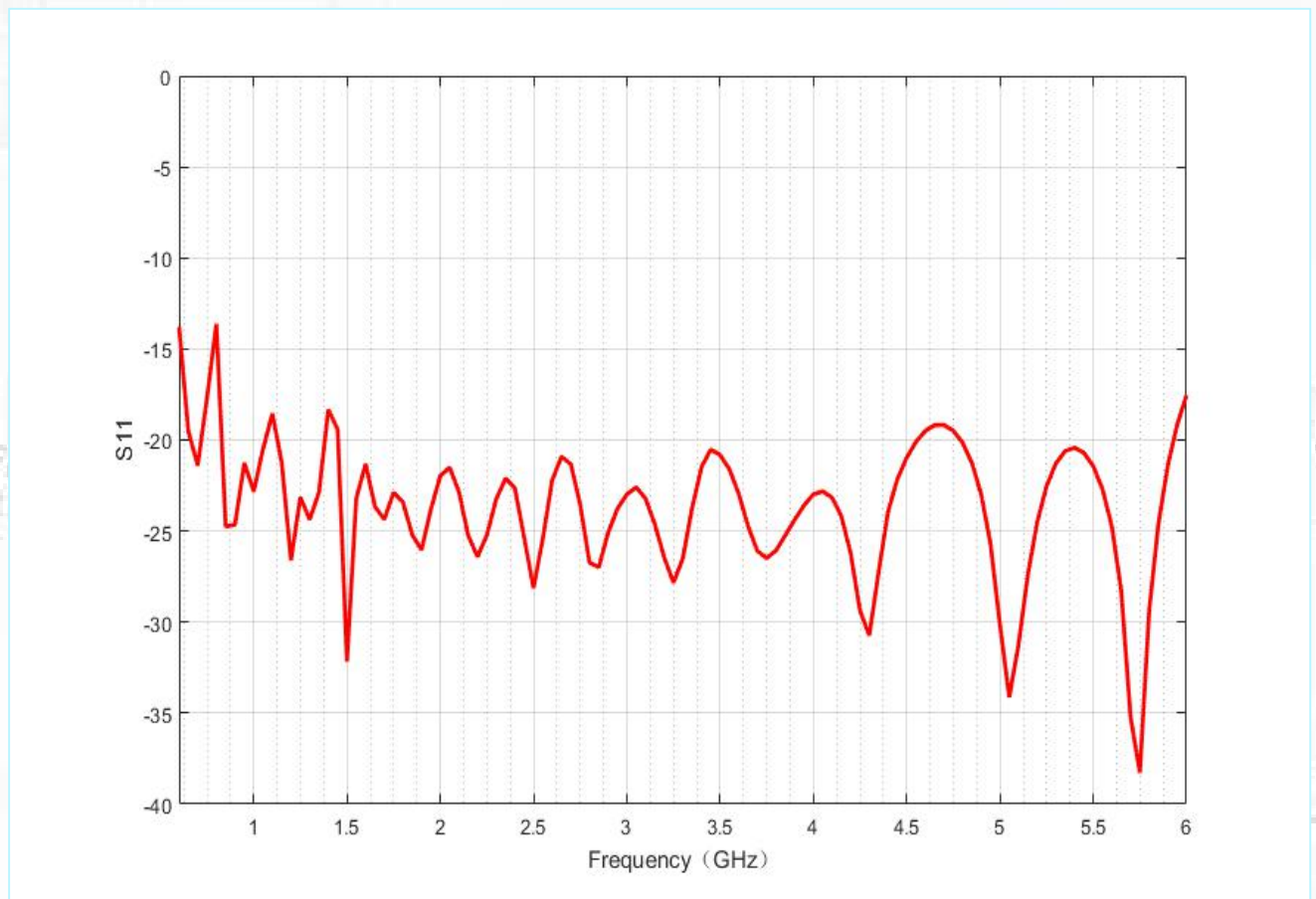

Maswell 5G High Gain Ultra Wideband Log Periodic Antenna

Simulation Results

VSWR

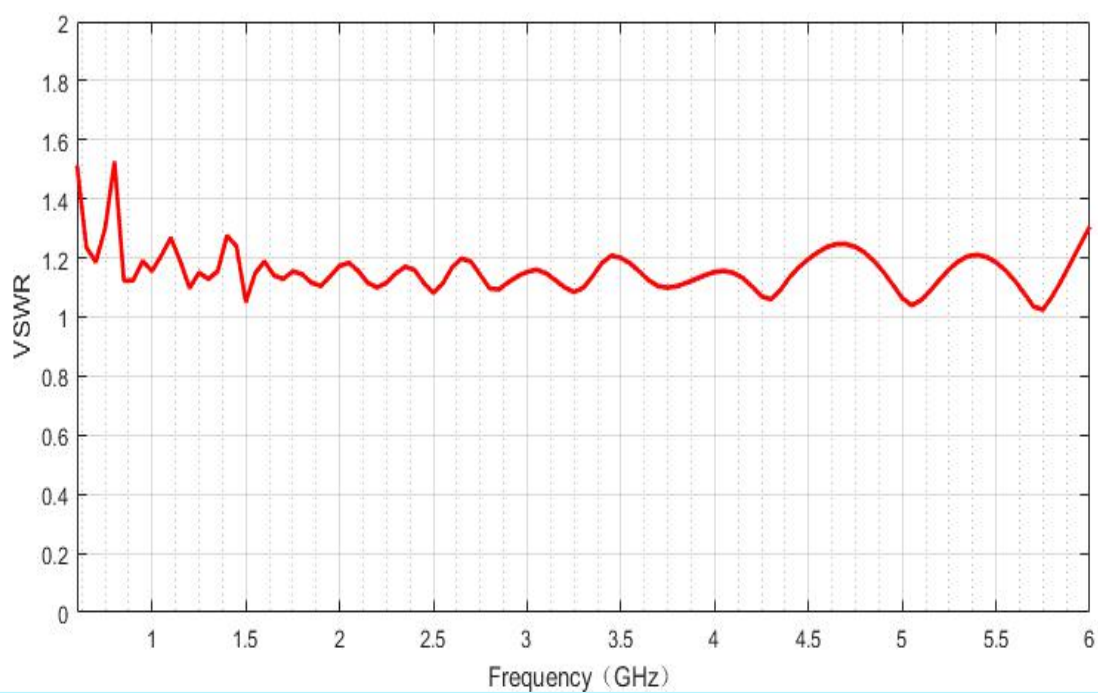

Maswell 5G High Gain Ultra Wideband Log Periodic Antenna

Simulation Results

Gain

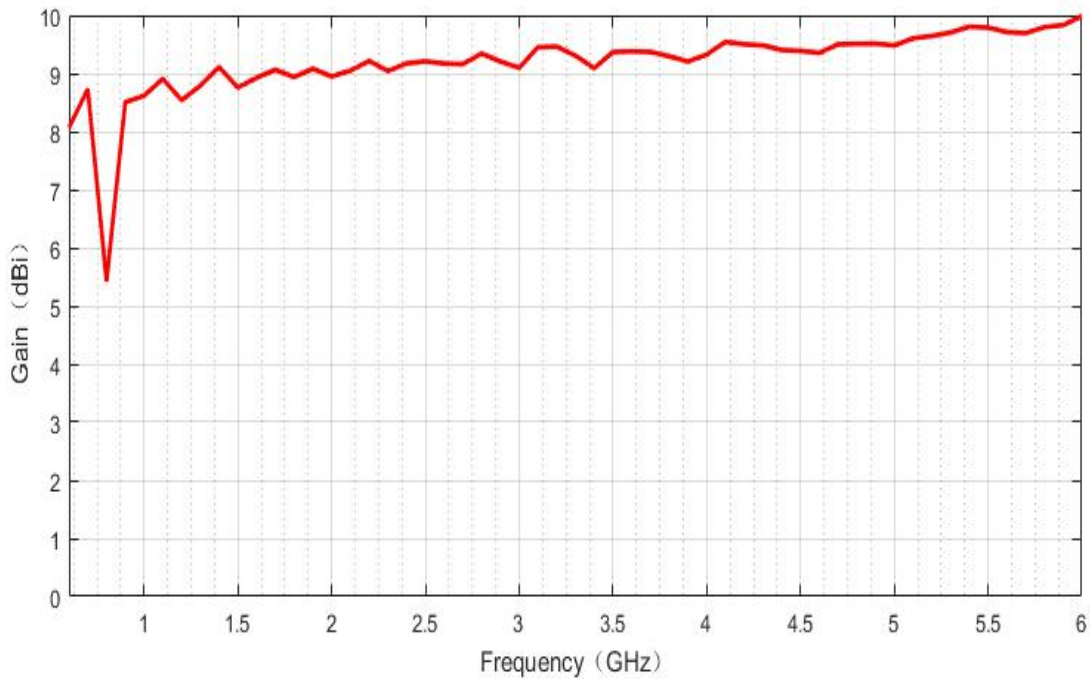

Maswell 5G High Gain Ultra Wideband Log Periodic Antenna

Simulation Results

Radiation Patterns

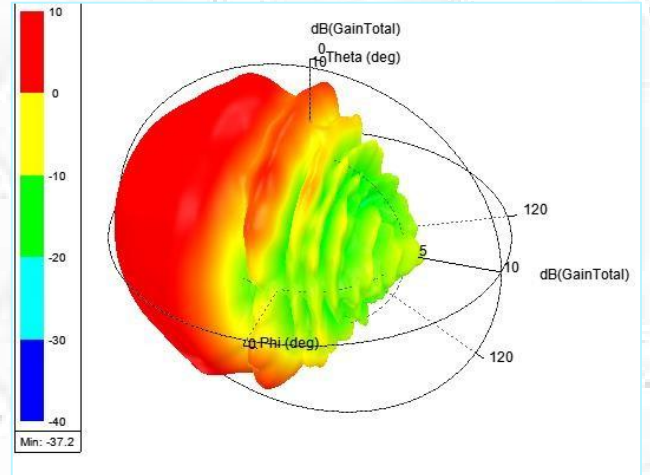
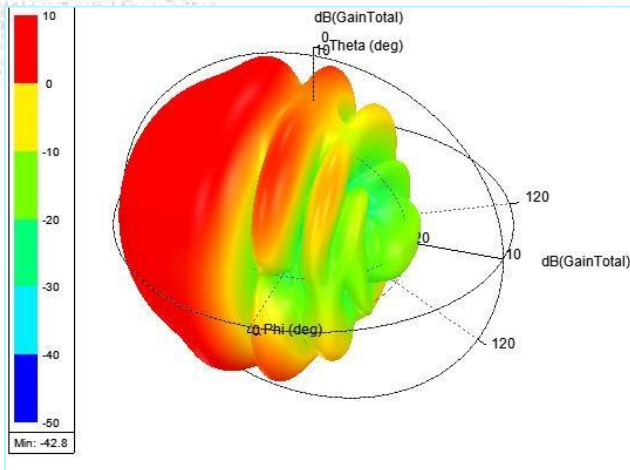
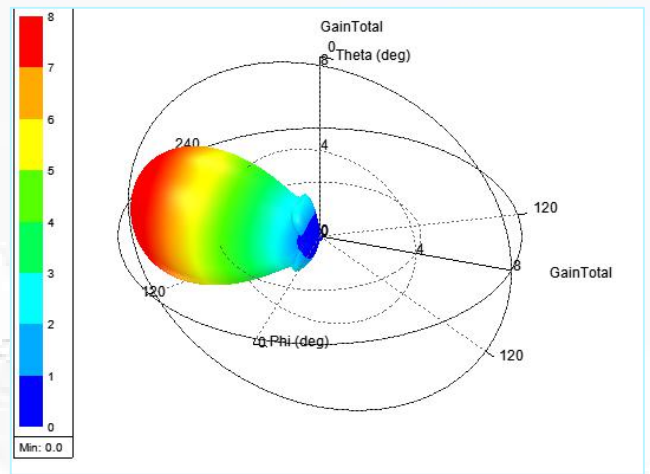
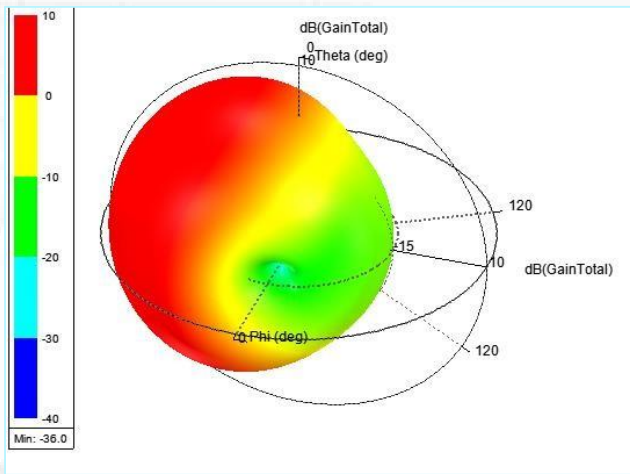

Maswell 5G High Gain Ultra Wideband Log Periodic Antenna

Simulation Results

Radiation Patterns

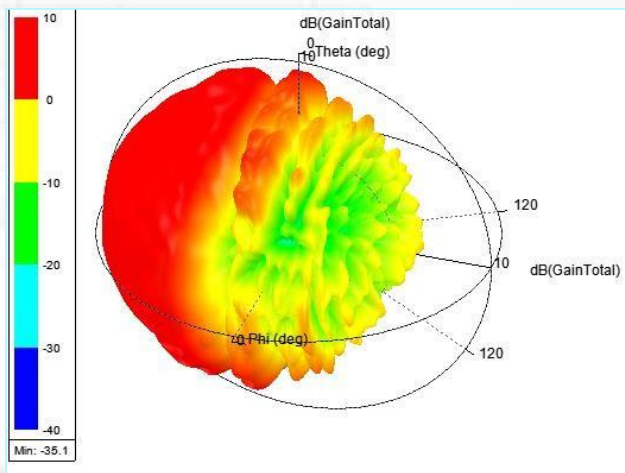

Maswell 5G High Gain Ultra Wideband Log Periodic Antenna

Measured Results

Measured S11 Result

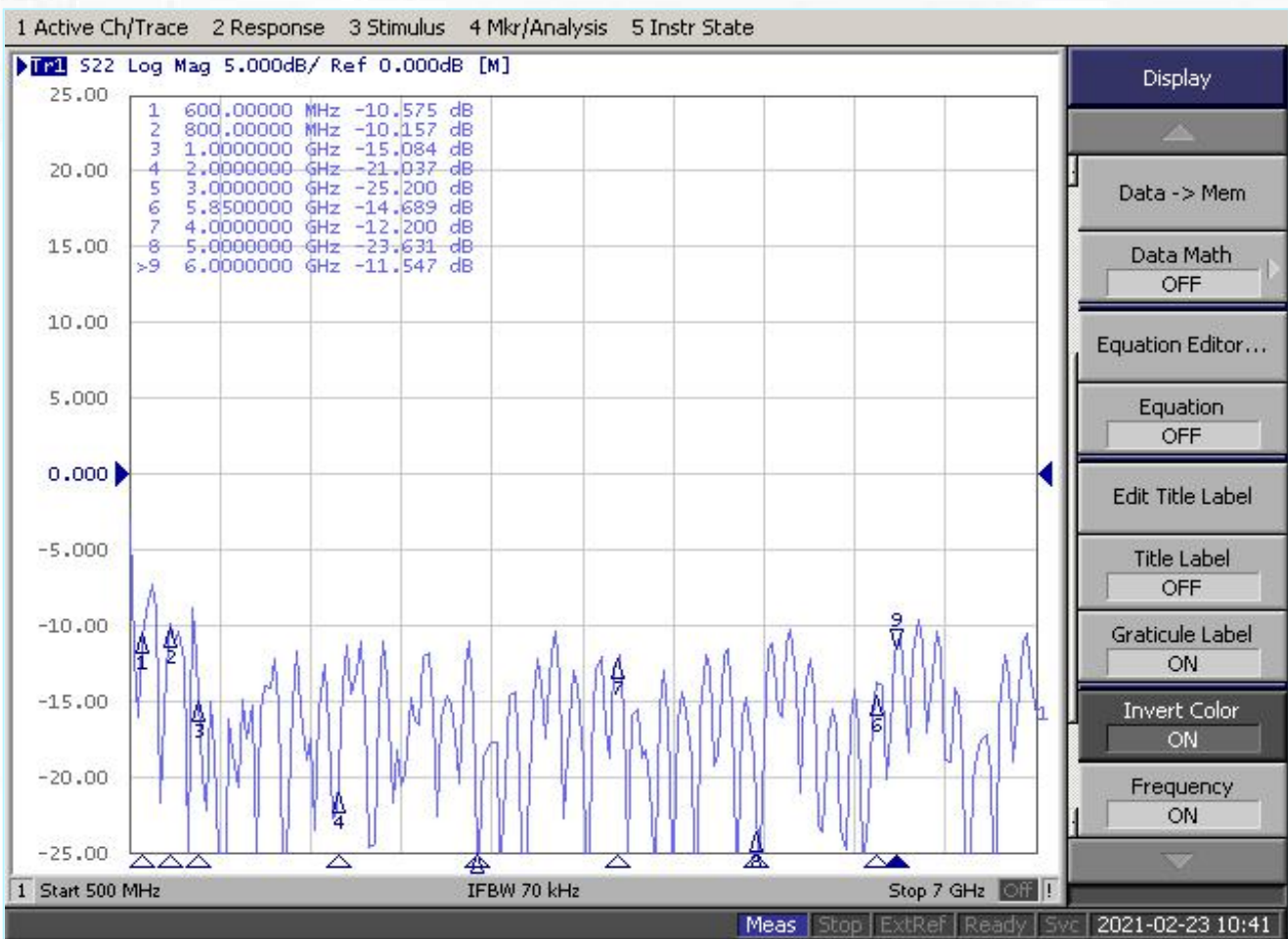

Maswell 5G High Gain Ultra Wideband Log Periodic Antenna

Measured Results

Measured VSWR

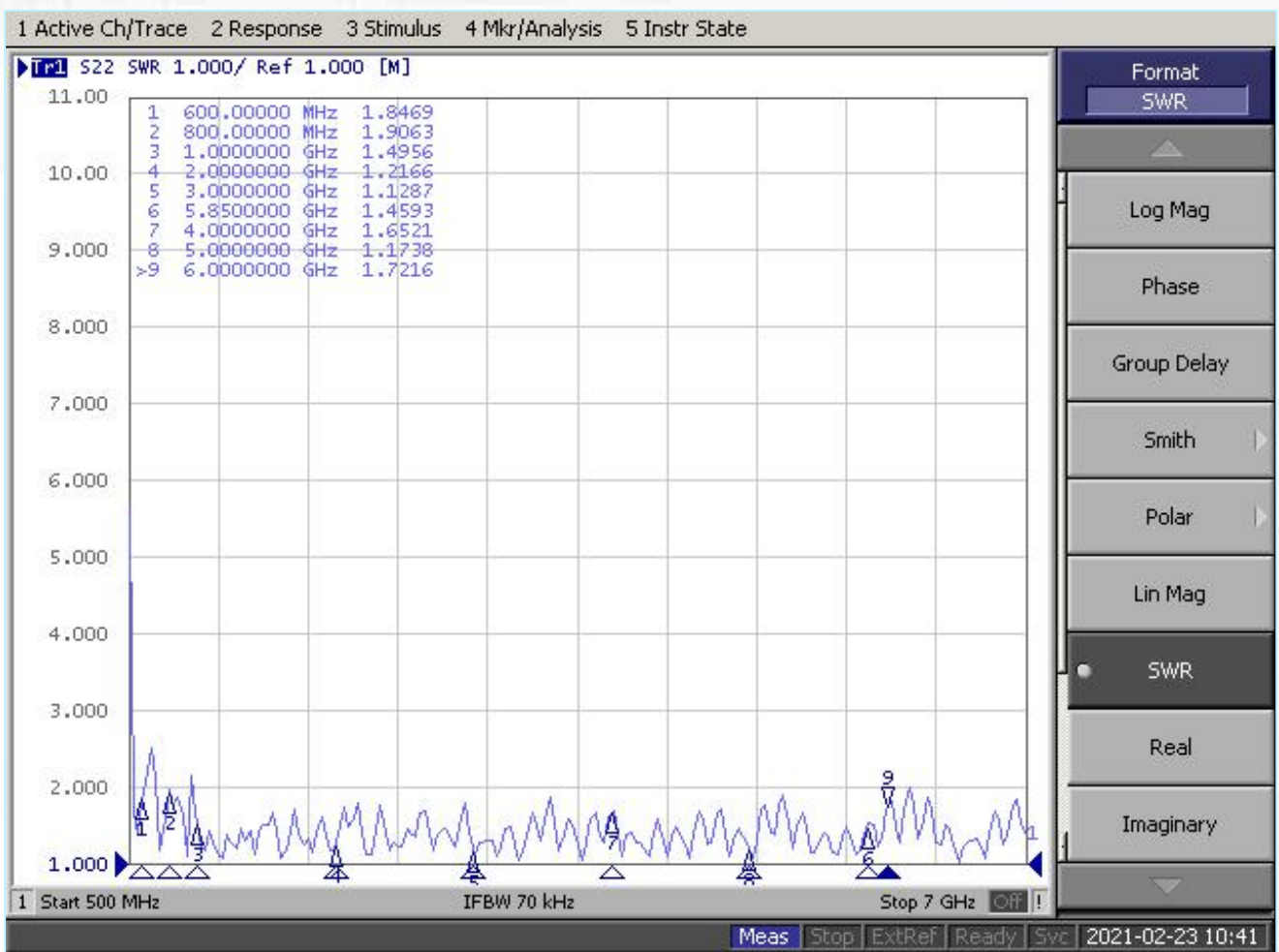

Maswell 5G High Gain Ultra Wideband Log Periodic Antenna

Measured Results

Measured Radiation efficiency

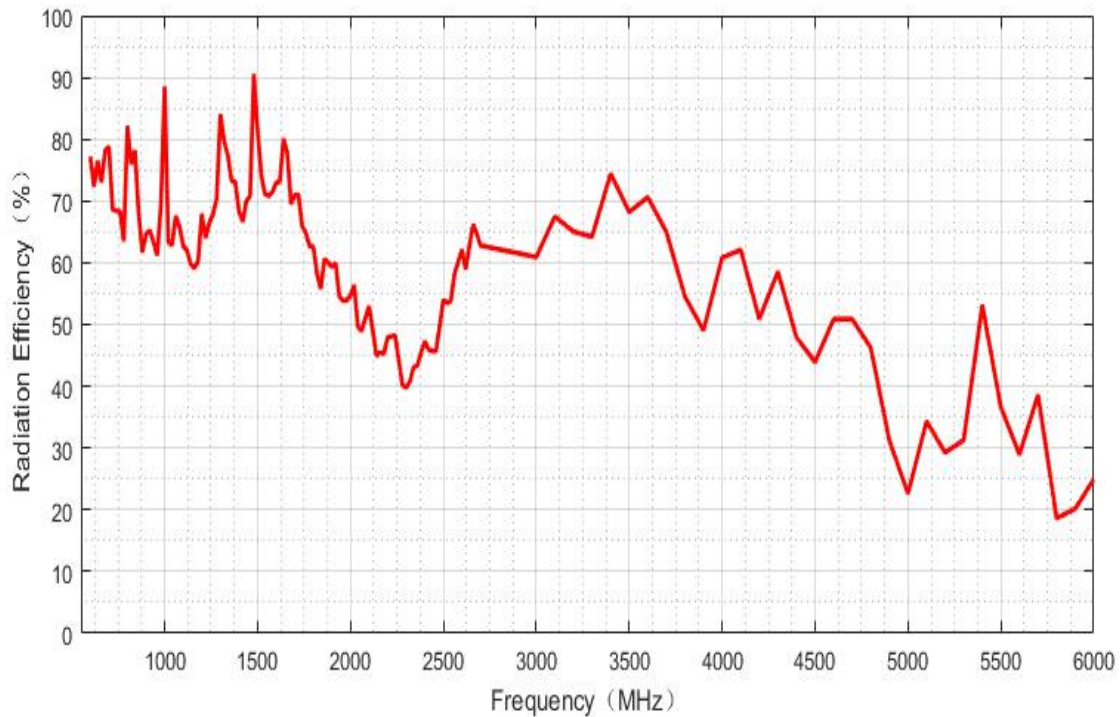

Maswell 5G High Gain Ultra Wideband Log Periodic Antenna

Measured Results

Measured Gain Result

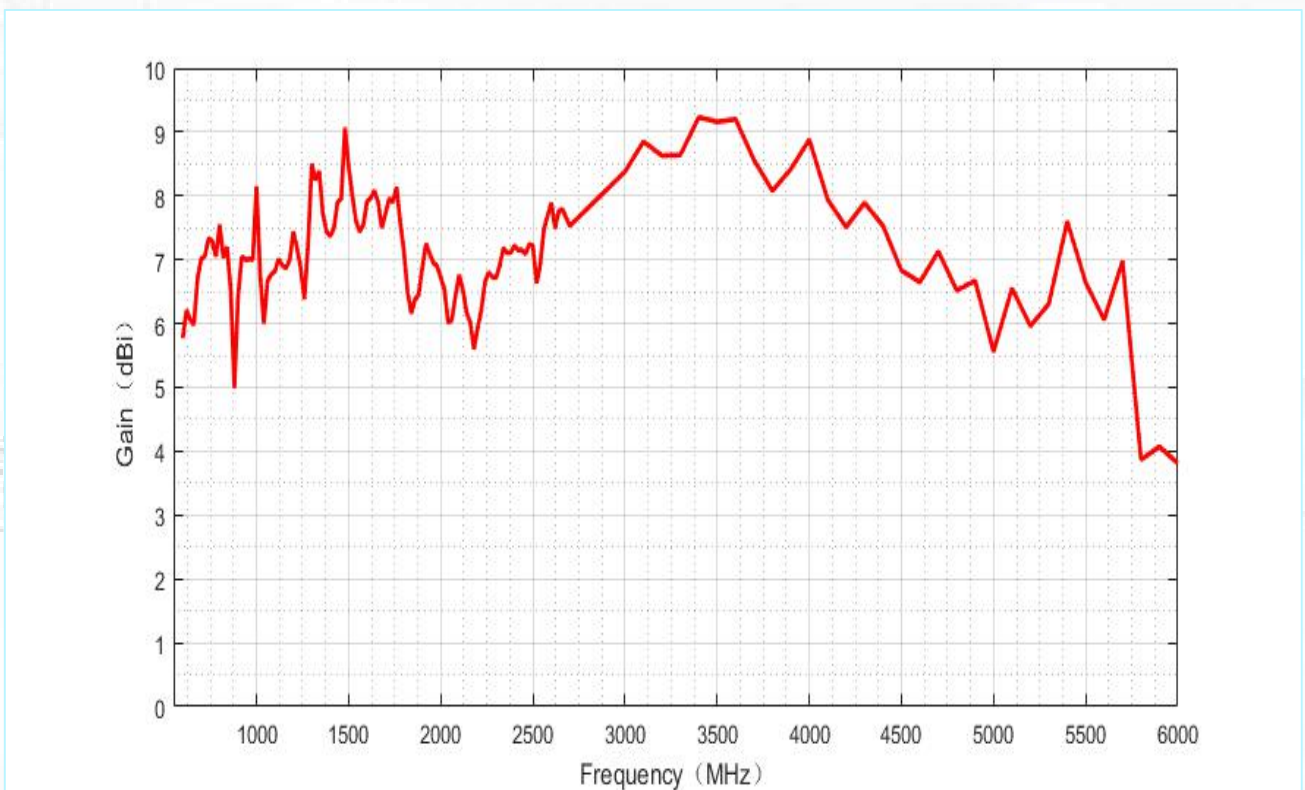

Maswell 5G High Gain Ultra Wideband Log Periodic Antenna

Measured Results

Measured Radiation Patterns

600MHz Radiation Pattern

1000MHz Radiation Pattern

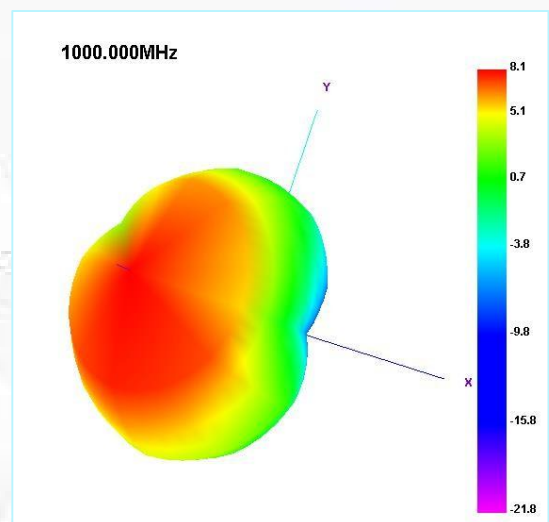
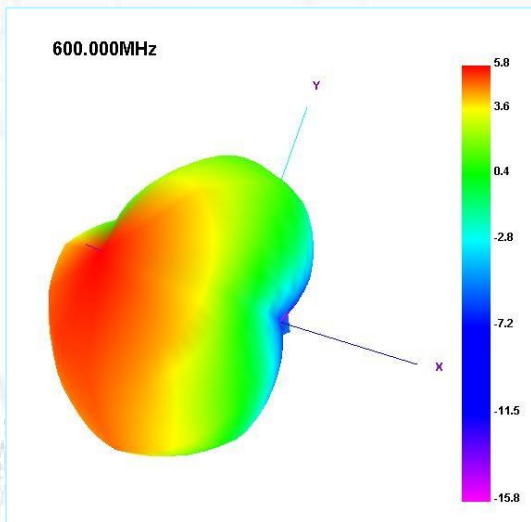

2000MHz Radiation Pattern

3000MHz Radiation Pattern

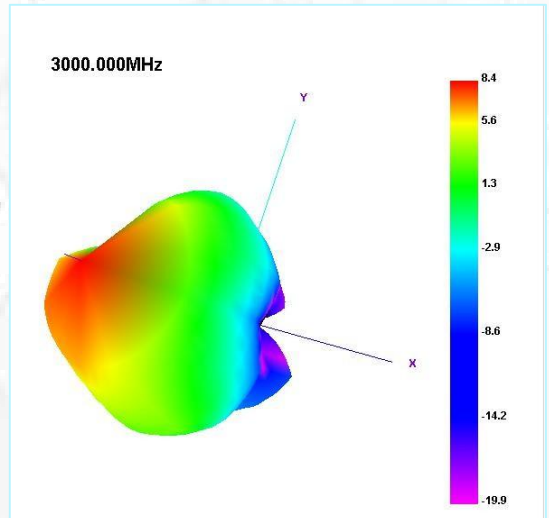
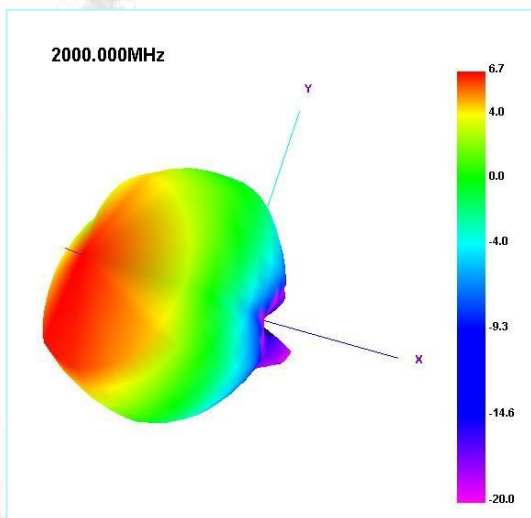

Maswell 5G High Gain Ultra Wideband Log Periodic Antenna

Measured Results

Measured Radiation Patterns

4000MHz Radiation Pattern 5000MHz Radiation Pattern

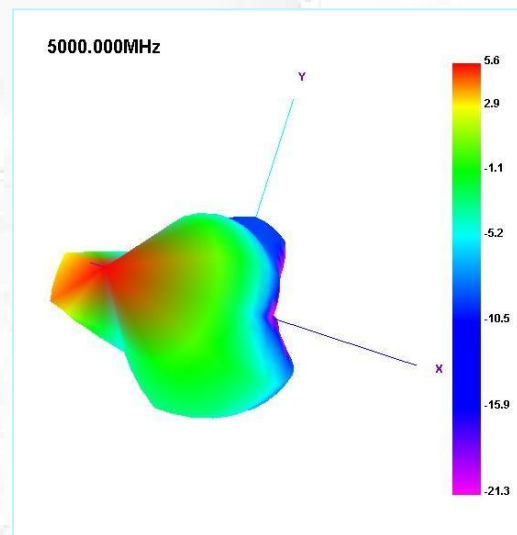
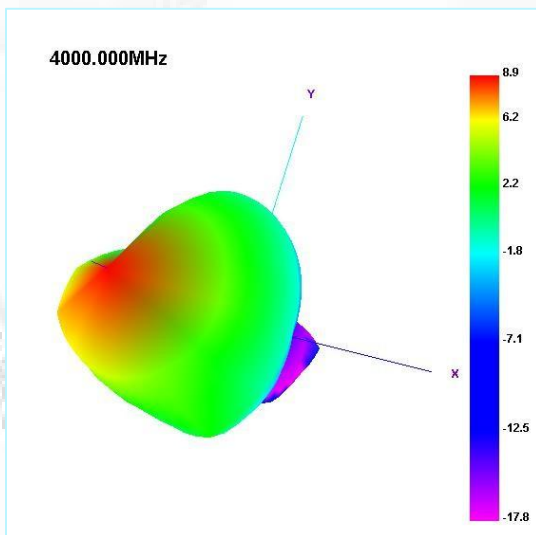

6000MHz Radiation Pattern

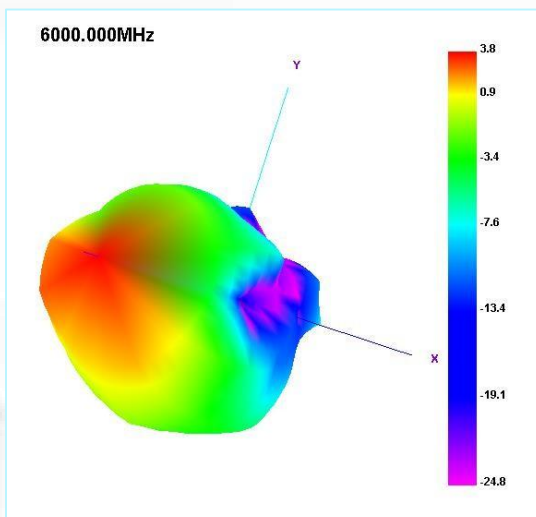

Maswell 5G High Gain Ultra Wideband Log Periodic Antenna

Measured Results

(Gain and Radiation Efficiency under 30cm lead)

Freq (MHz)	Effi (%)	Effi (dB)	Gain (dBi)	Gain (dBd)
600	27.4	-5.62	1.65	-0.5
700	45.45	-3.42	4.5	2.35
800	74.44	-1.28	6.56	4.41
900	63.8	-1.95	6.66	4.51
1000	78.78	-1.04	7.95	5.8
1100	60.26	-2.2	4.98	2.83
1200	66.14	-1.8	6.85	4.7
1300	72.01	-1.43	6.8	4.65
1400	67.41	-1.71	6.58	4.43
1500	65.77	-1.82	7.21	5.06
1600	50.65	-2.95	6.36	4.21
1700	48.14	-3.18	5.87	3.72
1800	56.78	-2.46	6.32	4.17
1900	55.53	-2.55	6.68	4.53
2000	55.45	-2.56	6.93	4.78
2100	57.09	-2.43	6.05	3.9
2200	53.17	-2.74	7.32	5.17
2300	52.92	-2.76	6.21	4.06
2400	62.77	-2.02	7.72	5.57
2500	74.42	-1.28	8.95	6.8
2600	69.29	-1.59	8.29	6.14
2700	71.08	-1.48	8.76	6.61
2800	69.41	-1.59	8.53	6.38
2900	65.89	-1.81	8.91	6.76
3000	69.63	-1.57	8.38	6.23
3100	63.98	-1.94	9.18	7.03
3200	58.62	-2.32	8.76	6.61

Maswell 5G High Gain Ultra Wideband Log Periodic Antenna

Measured Results (Gain and Radiation Efficiency under 30cm lead)

Freq (MHz)	Effi (%)	Effi (dB)	Gain (dBi)	Gain (dBd)
3300	63.98	-1.94	9.26	7.11
3400	68.52	-1.64	7.92	5.77
3500	59.42	-2.26	7.19	5.04
3600	57.43	-2.41	8.39	6.24
3700	55.96	-2.52	8.02	5.87
3800	52.9	-2.77	6.88	4.73
3900	62.28	-2.06	6.83	4.68
4000	67.03	-1.74	7.81	5.66
4100	62.16	-2.06	7.84	5.69
4200	59.78	-2.23	7.92	5.77
4300	62.96	-2.01	8.28	6.13
4400	57.49	-2.4	7.45	5.3
4500	53.71	-2.7	6.17	4.02
4600	42.22	-3.75	6.65	4.5
4700	40.84	-3.89	6.92	4.77
4800	42.91	-3.67	7.03	4.88
4900	42.16	-3.75	6.97	4.82
5000	39.71	-4.01	6.28	4.13
5100	51.49	-2.88	5.86	3.71
5200	47.3	-3.25	4.9	2.75
5300	40.94	-3.88	5.11	2.96
5400	53.72	-2.7	6.99	4.84
5500	53.54	-2.71	6.99	4.84
5600	47.31	-3.25	6.83	4.68
5700	50.66	-2.95	7.92	5.77
5800	48.83	-3.11	6.66	4.51
5900	41.86	-3.78	5.37	3.22
6000	42.75	-3.69	5.07	2.92

Maswell 5G High Gain Ultra Wideband Log Periodic Antenna

Package

AN_Master_005 MIMO

Package with five cartons:

1pc Low Loss Coaxial Cable per Carton

Cable Dimension: 340*60*340mm

Cable Gross Weight: 1150g

Cable Net Weight: 870g

unit : mm

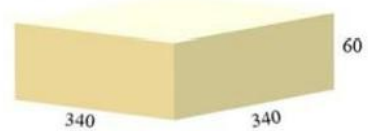

1pc LPDA Antenna Medium Gain per Carton

Antenna Dimension: 230*85*590mm

Antenna Gross Weight: 1400g

Antenna Net Weight: 990g

unit : mm



Installation Kit: U bolt

Dimension: 450*90*20mm

Weight: 1125g

