

Fail-Safe, Single Supply RS-232 Transceivers***UM3221E/UM3222E/UM3232E*****General Description**

The UM3221E/UM3222E/UM3232E series are 3.3V powered RS-232 transceivers intended for portable or hand-held applications. The UM3221E has one driver/one receiver while the UM3222E/UM3232E has two drivers/two receivers. The device features low power consumption, high data-rate capability and enhanced ESD protection. The ESD rating of all transmitter outputs and receiver inputs is $\pm 15\text{kV}$ for both human body mode and IEC61000-4-2 air discharge methods, and over $\pm 8\text{kV}$ for IEC61000-4-2 contact discharge methods. The logic I/O pins are protected to $\pm 2\text{kV}$ for human body mode.

Small footprint, low profile package and the use of small $0.1\mu\text{F}$ capacitors ensure board space savings as well. Data rates greater than 250kbps are guaranteed at worst case load conditions. This family is fully compatible with 3.3V-only systems, mixed 1.8V and 3.3V systems, mixed 3.3V and 5.0V systems and 5.0V-only systems.

The UM3221E/UM3222E has a low-power shutdown mode where the devices' driver outputs and charge pumps are disabled. During shutdown, the supply current falls to less than $1\mu\text{A}$ that reduces power consumption in battery-powered portable systems or other low power consumption systems. The UM3221E/UM3222E receivers remain active in shutdown mode, allowing monitoring of external signals.

The UM3221E/UM3222E and UM3232E are pin, package, and functionally compatible with the industry standard MAX242 and MAX 232, respectively.

Applications

- Industrial Automation Equipments
- Battery-Powered Equipments
- Hand-Held Equipments
- POS Terminals

Features

- Meets True EIA/TIA-232-F Standards from a +3.0V to +5.5V Power Supply
- Meets EIA/TIA-562 Levels of $\pm 3.7\text{V}$ with Supply Voltages as Low as 2.7V
- Enhanced ESD Specifications:
 - $\pm 15\text{kV}$ Human Body Mode
 - $\pm 15\text{kV}$ IEC61000-4-2 Air Discharge Mode
 - $\pm 8\text{kV}$ IEC61000-4-2 Contact Discharge Mode
- $1\mu\text{A}$ Low Power Shutdown (UM3221E/UM3222E)
- 250kbps Minimum Transmission Rate
- Guaranteed $30\text{V}/\mu\text{s}$ Max Slew Rate
- Latch-Up Performance Exceeds 200mA
- Hot Swap and Fail-Safe
- I/O Logic Compatible with 1.8V Logic @ $V_{\text{CC}}=3.3\text{V}$

Ordering Information

Part Number	Temp. Range	Package Type	Shipping Qty
UM3221EEAE	-40°C to +85°C	SSOP16	2000pcs/13 Inch Tape & Reel
UM3221EEUE	-40°C to +85°C	TSSOP16	3000pcs/13 Inch Tape & Reel
UM3222EEUE	-40°C to +85°C	TSSOP20	3000pcs/13 Inch Tape & Reel
UM3232EESE	-40°C to +85°C	SOP16	2500pcs/13 Inch Tape & Reel
UM3232EEPE	-40°C to +85°C	DIP16	25pcs/Tube
UM3232EEUE	-40°C to +85°C	TSSOP16	3000pcs/13 Inch Tape & Reel
UM3232EEAE	-40°C to +85°C	SSOP16	2000pcs/13 Inch Tape & Reel

Pin Configurations

Top View

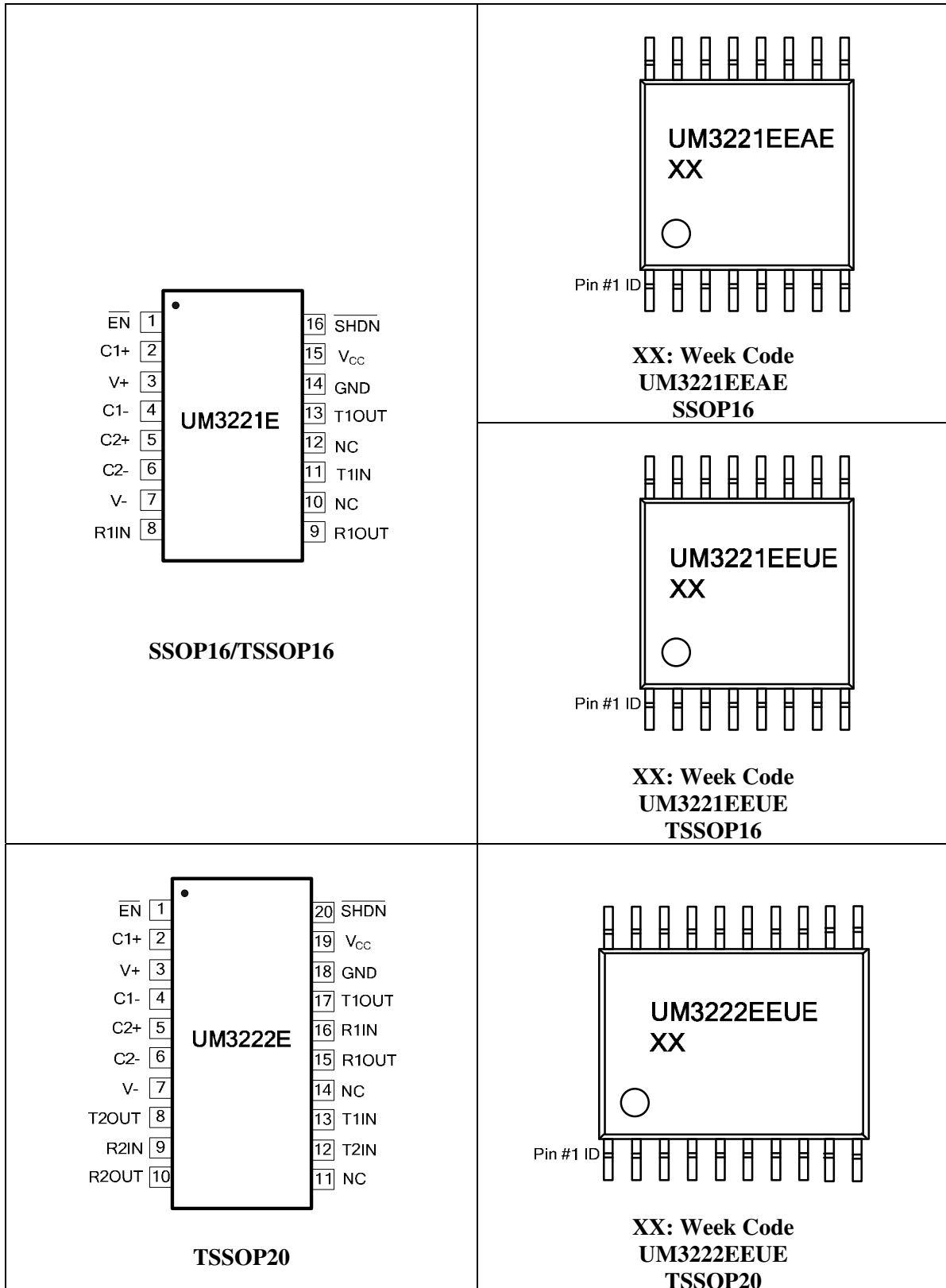

Pin Configurations

Top View

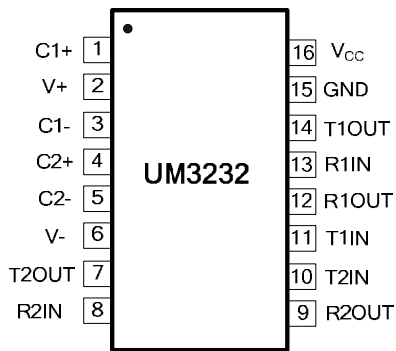

SOP16/DIP16/TSSOP16/SSOP16

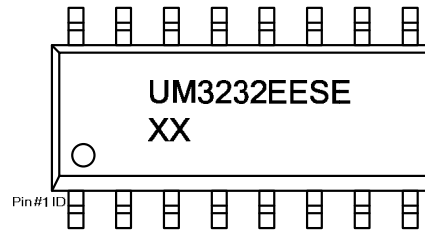

XX: Week Code
UM3232EESE
SOP16

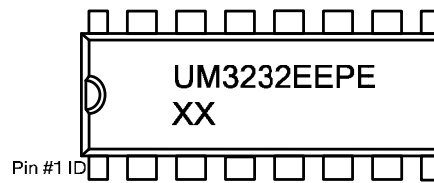

XX: Week Code
UM3232EEPE
DIP16

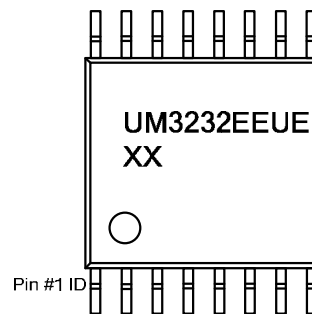

XX: Week Code
UM3232EEUE
TSSOP16

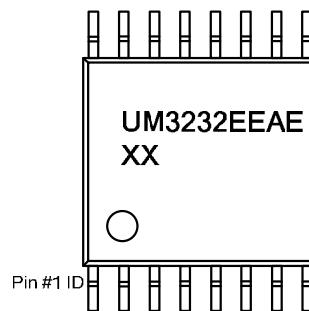

XX: Week Code
UM3232EEAE
SSOP16

Pin Description

Pin No.			Pin Name	Function
UM3221E	UM3222E	UM3232E		
1	1	-	$\overline{\text{EN}}$	Receiver Enable. Active low.
2	2	1	C1+	Positive Terminals of Voltage-Doubler Charge Pump Capacitor
3	3	2	V+	Positive Voltage Generated by the Charge Pump
4	4	3	C1-	Negative Terminals of Voltage-Doubler Charge Pump Capacitor
5	5	4	C2+	Positive Terminals of Inverting Charge Pump Capacitor
6	6	5	C2-	Negative Terminals of Inverting Charge Pump Capacitor
7	7	6	V-	Negative Voltage Generated by the Charge Pump
13	8, 17	7, 14	T_OUT	RS-232 Driver Outputs
8	9, 16	8, 13	R_IN	RS-232 Receiver Inputs
9	10, 15	9, 12	R_OUT	RS-232 Receiver Outputs
11	12, 13	10, 11	T_IN	RS-232 Driver Inputs
14	18	15	GND	Ground
15	19	16	V _{CC}	+3.0V to +5.5V Supply Voltage Input
16	20	-	$\overline{\text{SHDN}}$	Shut off Pump Power and Transmitters. Active low.

Absolute Maximum Ratings (Note 1)

Symbol	Parameter	Value	Unit	
V _{CC}	Supply Voltage on V _{CC}	-0.3 to +6	V	
V ₊	Voltage on V ₊	(V _{CC} -0.3) to +7.5	V	
V ₋	Voltage on V ₋	-7.5 to +0.3	V	
T _{IN}	Voltage on T _{IN}	-0.3 to (V _{CC} +0.3)	V	
R _{IN}	Voltage on R _{IN}	±30	V	
T _{OUT}	Voltage on T _{OUT}	(V ₋ -0.3) to (V ₊ +0.3)	V	
R _{OUT}	Voltage on R _{OUT}	-0.3 to (V _{CC} +0.3)	V	
	Short-Circuit Duration, T _{OUT}	Continuous		
P _D	Continuous Power Dissipation at T _A =70°C	SSOP16	775	mW
		TSSOP20	879	
		SOP16	696	
		DIP16	842	
		TSSOP16	754	
T _A	Operating Temperature Range	-40 to +85	°C	
T _{STG}	Storage Temperature Range	-65 to +165	°C	
T _L	Maximum Lead Temperature for Soldering 10 Seconds	+300	°C	

Note 1: Stresses beyond those listed under “Absolute Maximum Ratings” may cause permanent damage to the device. These are stress ratings only, and functional operation of the device at these or any other conditions beyond those indicated in the operational sections of the specifications is not implied. Exposure to absolute maximum rating conditions for extended periods may affect device reliability.

Electrical Characteristics

($V_{CC}=+3.0V$ to $+5.5V$, $C1- C4=0.1\mu F$, $T_A=T_{MIN}$ to T_{MAX} , unless otherwise noted. Typical values are at $T_A=25^\circ C$)

Parameter	Symbol	Conditions	Min	Typ	Max	Unit	
DC CHARACTERISTICS ($V_{CC}=+3.3V$ or $+5V$, $T_A=25^\circ C$)							
V_{CC} Supply Current	I_{CC}	$\overline{SHDN}=V_{CC}$, No Load			1.5	mA	
Shutdown Supply Current	I_{SHDN}	$\overline{SHDN}=GND$			1	μA	
LOGIC INPUTS							
Input Leakage Current		T_{IN} , \overline{SHDN} , \overline{EN}			± 1	μA	
Input Threshold Low	V_{IL}	$\frac{T_{IN}}{\overline{SHDN}}, \overline{EN}$	$V_{CC}=3.3V$		0.8	V	
			$V_{CC}=5.0V$		0.8		
Input Threshold High	V_{IH}	$\frac{T_{IN}}{\overline{SHDN}}, \overline{EN}$	$V_{CC}=3.3V$	1.6		V	
			$V_{CC}=5.0V$	2.2			
Transmitter Input Hysteresis			$V_{CC}=3.3V$		0.2	V	
			$V_{CC}=5.0V$		0.15		
RECEIVER OUTPUTS							
Output Voltage Low	V_{OL}		$V_{CC}=3.3V, I_{OUT}=10mA$		0.8	V	
			$V_{CC}=5.0V, I_{OUT}=10mA$		0.8		
Output Voltage High	V_{OH}		$V_{CC}=3.3V, I_{OUT}=-3.0mA$	2.8		V	
			$V_{CC}=5.0V, I_{OUT}=-3.0mA$	4.4			
RECEIVER INPUTS							
Input Voltage Range			-30		30	V	
Input Threshold Low		$T_A=+25^\circ C$	$V_{CC}=3.3V$	0.8	1.15	V	
			$V_{CC}=5.0V$	0.8	1.55		
Input Threshold High		$T_A=+25^\circ C$	$V_{CC}=3.3V$		1.35	V	
			$V_{CC}=5.0V$		1.75		
Input Hysteresis				0.2		V	
Input Resistance		$T_A=+25^\circ C$	3	5	7	k Ω	
TRANSMITTER OUTPUTS							
Output Voltage Swing		All Drivers Loaded with $3k\Omega$ to Ground	± 5.0	± 6.0		V	
Output Short-Circuit Current		Short to V_{CC} , GND or Other TXD Pin	$V_{CC}=3.3V$		± 30	± 60	mA
			$V_{CC}=5.0V$		± 40	± 60	mA

Electrical Characteristics (Continued)

($V_{CC}=+3.0V$ to $+5.5V$, $C1- C4=0.1\mu F$, $T_A=T_{MIN}$ to T_{MAX} , unless otherwise noted. Typical values are at $T_A=25^\circ C$)

Parameter	Symbol	Conditions	Min	Typ	Max	Unit
TIMING CHARACTERISTICS						
Maximum Data Rate		$R_L=3k\Omega$ to $7k\Omega$, $C_L=50pF$ to $1000pF$, One Transmitter Switching		250		kbps
Receiver Propagation Delay	t_{PLH} , t_{PHL}	$C_L=150pF$ Figure 1		0.15		μs
Receiver Skew	$ t_{PHL}-t_{PLH} $				0.1	μs
Transmitter Propagation Delay	t_{PLH} , t_{PHL}	$R_L=3k\Omega$, $C_L=2500pF$, All Transmitters Loaded Figure 1		0.9		μs
Transmitter Skew	$ t_{PHL}-t_{PLH} $				0.1	μs
Transition-Region Slew Rate		$T_A=+25^\circ C$, $V_{CC}=3.3V$, $R_L=3k\Omega$ to $7k\Omega$, $C_L=50pF$ to $1000pF$, Measured from $-3V$ to $+3V$ or $+3V$ to $-3V$, Figure 1	3	15	30	$V/\mu s$
ESD AND LATCH UP PERFORMANCE						
R_IN, T_OUT ESD-Protection Voltage		Human Body Model		± 15		kV
		IEC61000-4-2, Contact Discharge		± 8		
		IEC61000-4-2, Air-Gap Discharge		± 15		
Logic Pin ESD-Protection Voltage		Human Body Model		± 2		kV
Latch Up Performance		JEDEC Standard No.78D		± 200		mA

Detailed Description

Dual Charge-Pump Voltage Converter

The UM3221E/UM3222E/UM3232Es' internal power supply consists of a regulated dual charge pump and provides output the maxim voltages of +7V (doubling charge pump) and -7V (inverting charge pump) over the +3.0V to +5.5V V_{CC} range. The charge pump operates in discontinuous mode; if the output voltages are less than 7V, the charge pump is enabled, and if the output voltages exceed 7V, the charge pump is disabled. The charge pumps require only four small, external 0.1 μ F capacitors for the voltage doubler and inverter functions (see Figure 2).

RS-232 Transmitters

The transmitters are inverting level translators that translate TTL/CMOS inputs to EIA/TIA-232 output levels. All UM3221E/UM3222E/UM3232E transmitters guarantee a 250kbps data rate for full load conditions (3k Ω and 1000pF). Transmitters can be paralleled to drive multiple receivers. When T_IN is not driven, UM3221/UM3222 will keep logic high, while UM3232's T_IN logic level is on hold.

RS-232 Receivers

The receivers convert RS-232 signals to CMOS output levels and accept inputs up to ± 30 V while presenting the required 3k Ω to 7k Ω input impedance. The UM3221E/UM3222E receivers have inverting three-state outputs. Drive \overline{EN} high to place the receivers into a high impedance state. Receivers can be either active or inactive in shutdown state depending on \overline{EN} status.

UM3221E/UM3222E

Supply current falls to less than 1 μ A in shutdown mode ($\overline{SHDN} = \text{GND}$). When shutdown, the device's charge pumps are shut off, V+ is pulled down to V_{CC} , V- is pulled to ground, and the transmitter outputs are disabled (high impedance). The time required to recover from shutdown is typically 100 μ s. Connect \overline{SHDN} to V_{CC} if shutdown mode is not used. \overline{SHDN} has no effect on R_OUT.

± 15 kV ESD Protection

All pins on UM3221E/UM3222E/UM3232E devices include ESD protection structures, but the family incorporates advanced structures which allow the RS-232 pins (transmitter outputs and receiver inputs) to survive ESD events up to ± 15 kV. The RS-232 pins are particularly vulnerable to ESD damage because they are typically connected to an exposed port on the exterior of the finished product. The ESD structures withstand high ESD in all states: normal operation, shutdown and powered down. After an ESD event, circuits keep working without latch up. ESD protection can be tested in various ways; the transmitter outputs and receiver inputs are characterized for protection to the following limits: ± 15 kV using the Human Body Model, ± 8 kV using the Contact Discharge method specified in IEC61000-4-2, ± 15 kV using the Air-Gap Discharge method specified in IEC61000-4-2. The logic pins are characterized for protection to the following limit: ± 2 kV using the Human Body Model.

Hot Swap and Fail-Safe

The UM3221E/UM3222E/UM3232E guarantees a logic-high receiver output when the receiver inputs are shorted to GND or open, or when they are connected to a line with no driver enabled.

Because of the latch-up characteristics and all sort protection, UM3221E/UM3222E/UM3232E support hot swap.

Test Circuits

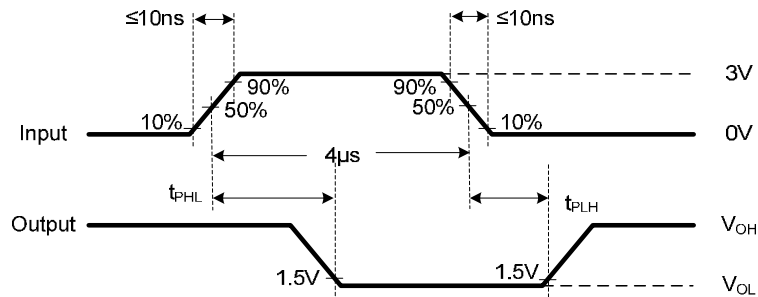
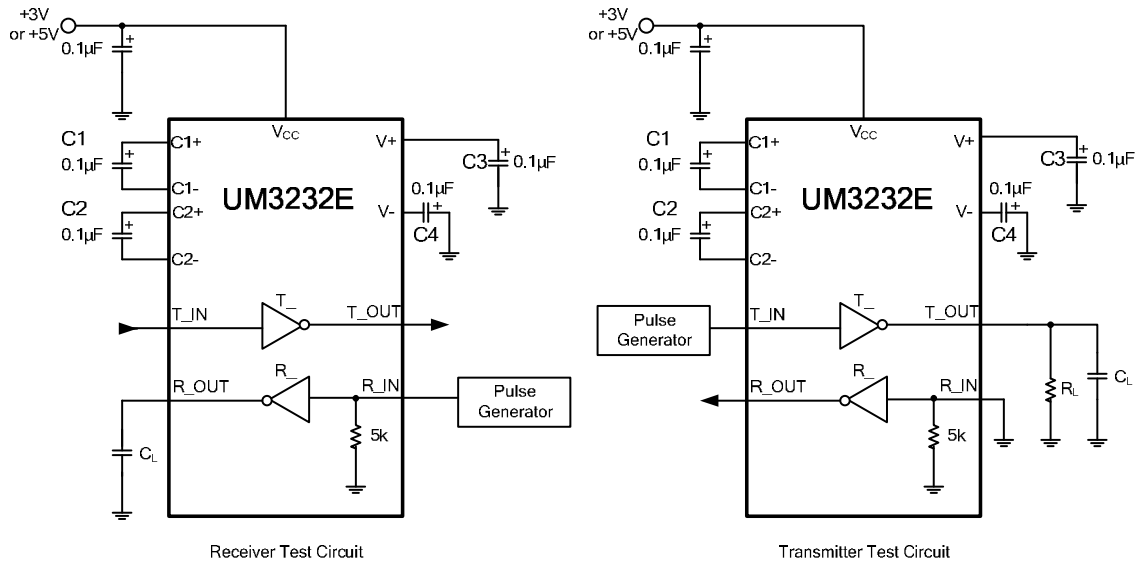

Receiver Waveforms

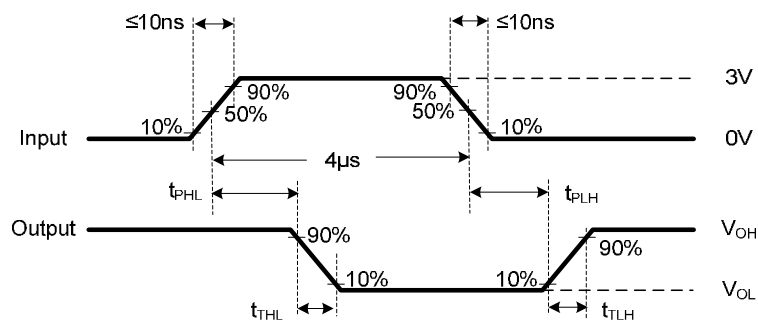

Transmitter Waveforms

Figure 1

Typical Operating Circuits

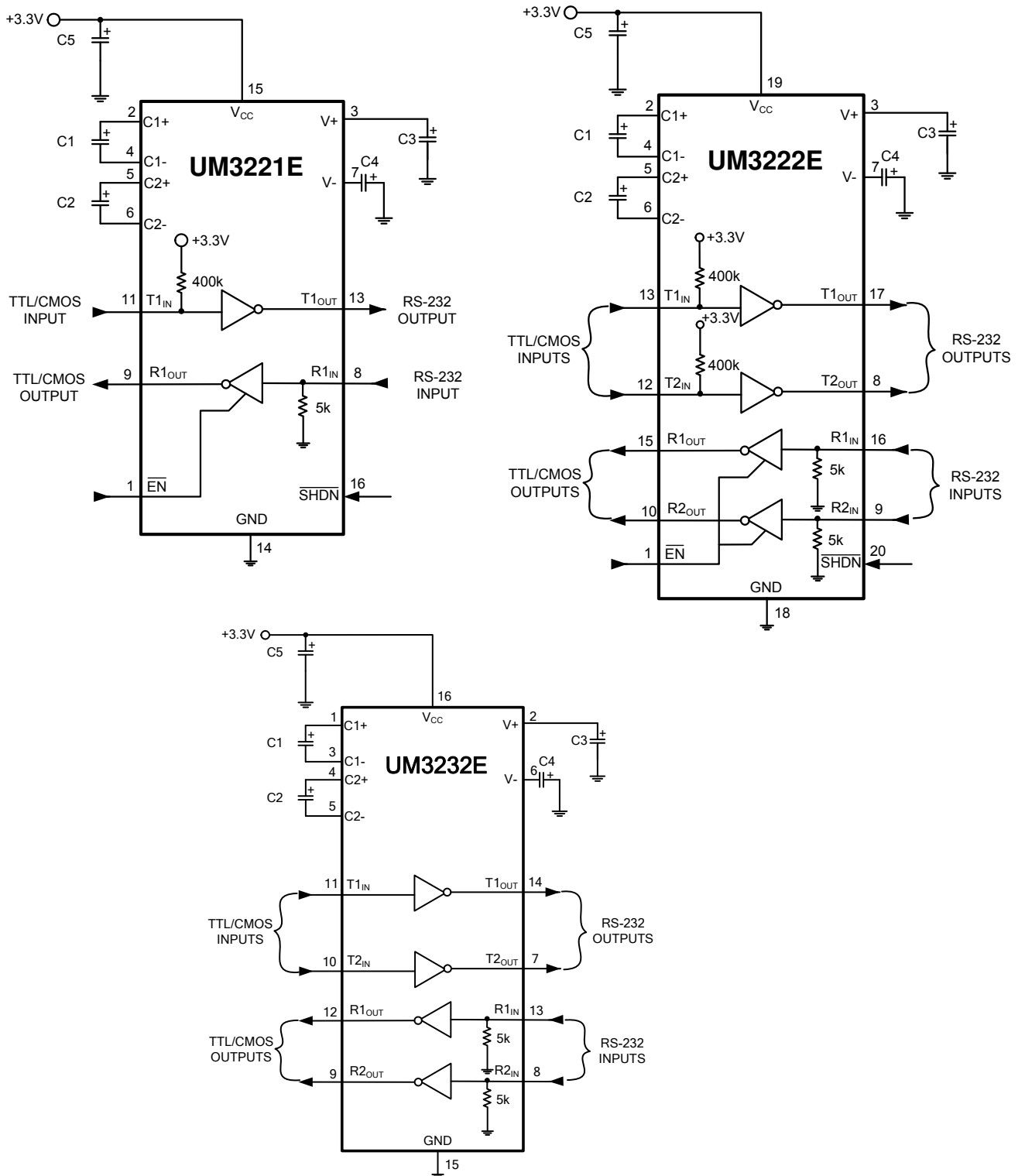
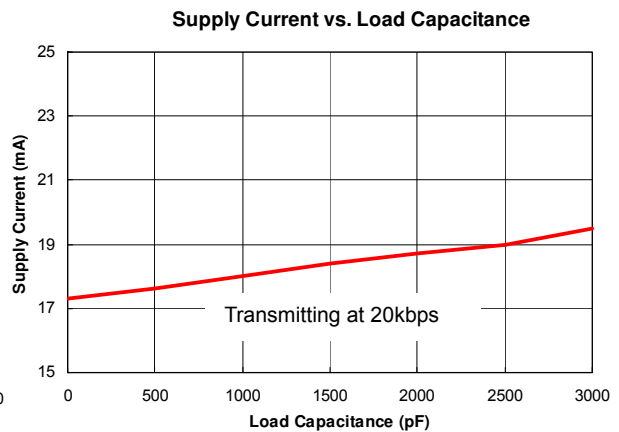
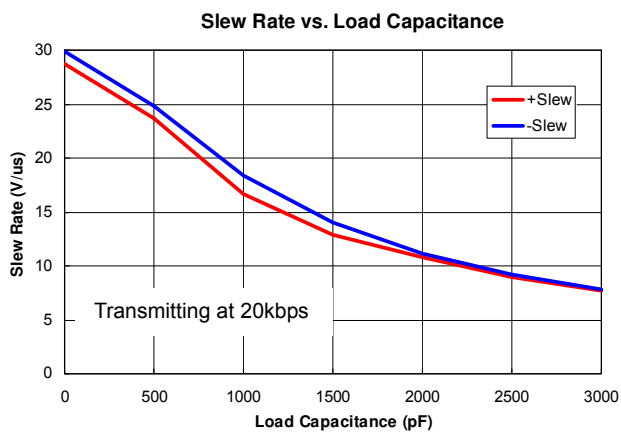
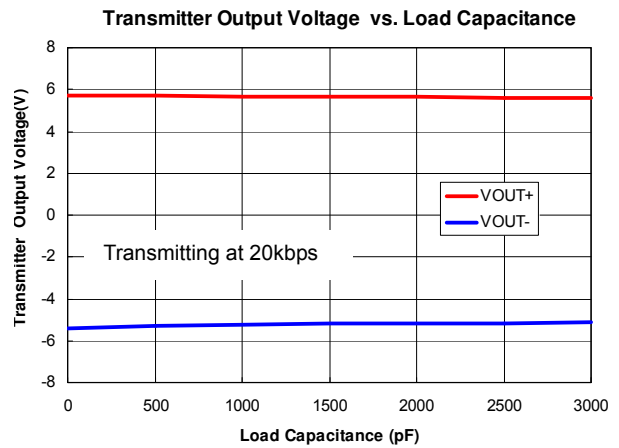
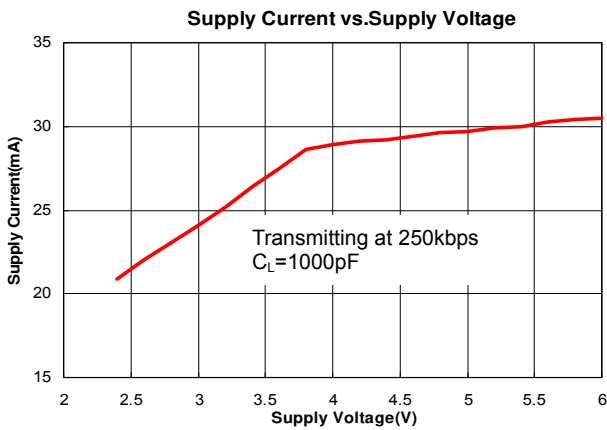
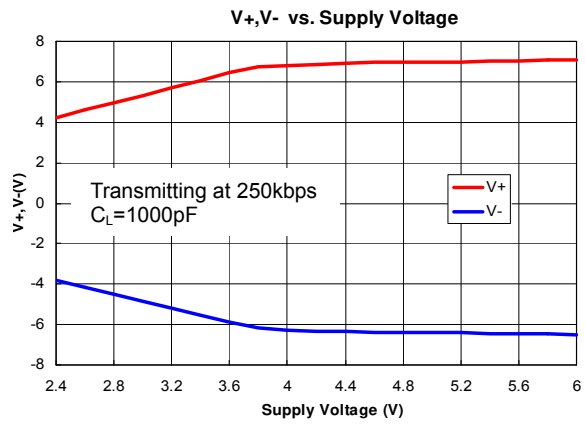
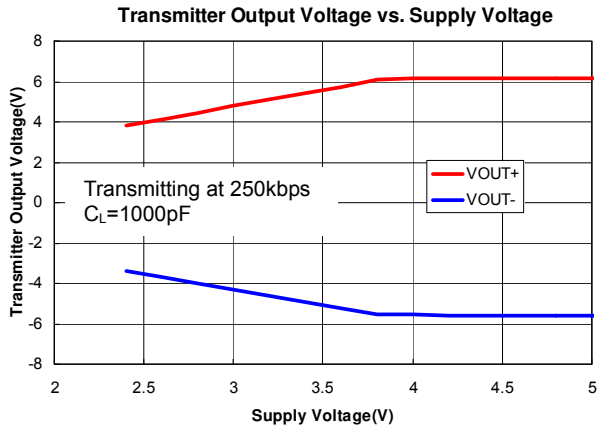

Figure 2

Typical Operating Characteristics

($V_{CC}=+3.3V$, 250kbps data rate, $0.1\mu F$ capacitors, all transmitters loaded with $3k\Omega$ and C_L , $T_A=25^\circ C$, unless otherwise noted.)



Applications Information

Capacitor Selection

The capacitor type used for C1–C4 is not critical for proper operation; polarized or non-polarized capacitors can be used. The charge pump requires 0.1 μ F capacitors for 3.3V operation. Increasing the capacitor values (e.g. by a factor of 2) reduces ripples on the transmitter outputs and slightly reduces power consumption. C2, C3 and C4 can be increased without changing C1's value. When using the minimum required capacitor values, make sure the capacitor value does not degrade excessively with temperature. If in doubt, use capacitors with a larger nominal value. The capacitor's equivalent series resistance (ESR), which usually rises at low temperatures, influences the amount of ripples on V+ and V- output voltages.

The following table shows some recommended minimum required pump capacitor values for different input voltage ranges.

Minimum Required Pump Capacitor Value	
Input Voltage V _{CC}	Charge Pump Capacitor Value for UM32XX
2.7V to 3.6V	C1–C4=0.1 μ F
3.6V to 5.5V	C1–C4=0.47 μ F
2.7V to 5.5V	C1–C4=0.47 μ F

Power Supply Decoupling

In most circumstances, a 0.1 μ F V_{CC} bypass capacitor is adequate. In applications sensitive to power-supply noise, use a capacitor of the same value as charge pump capacitor C1. Connect bypass capacitors to the IC as close as possible.

Operation down to 2.7V

Transmitter outputs meet EIA/TIA-562 levels of ± 3.7 V with supply voltages as low as 2.7V.

Interconnection with 3V and 5V Logic

The UM3221E/UM3222E/UM3232E can directly interface with various 3V and 5V logic families, including ACT and HCT CMOS.

Package Information

UM3232E ESE SOP16

Outline Drawing

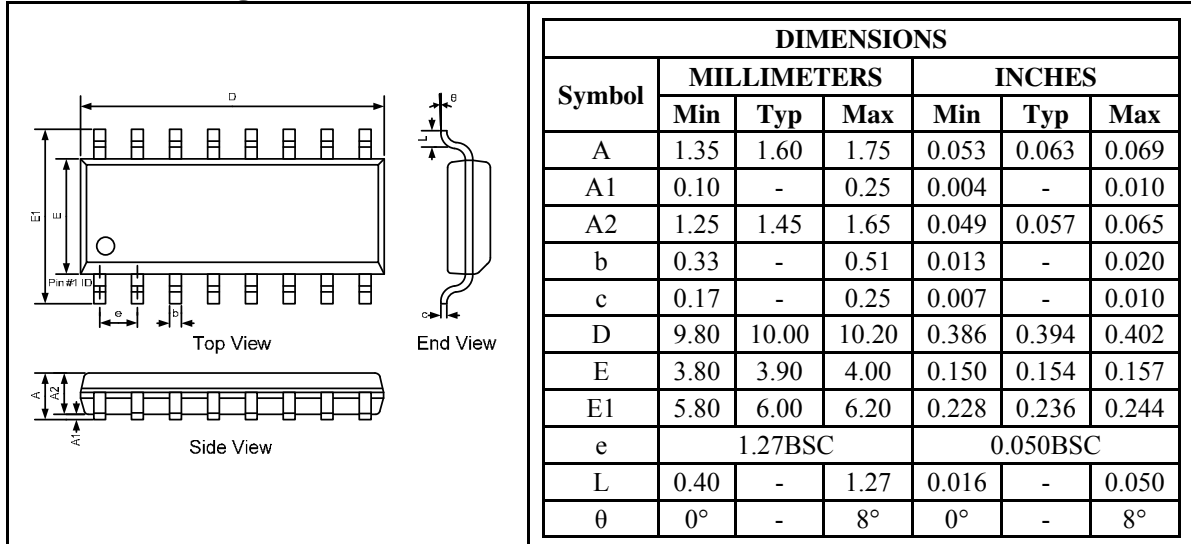

Land Pattern

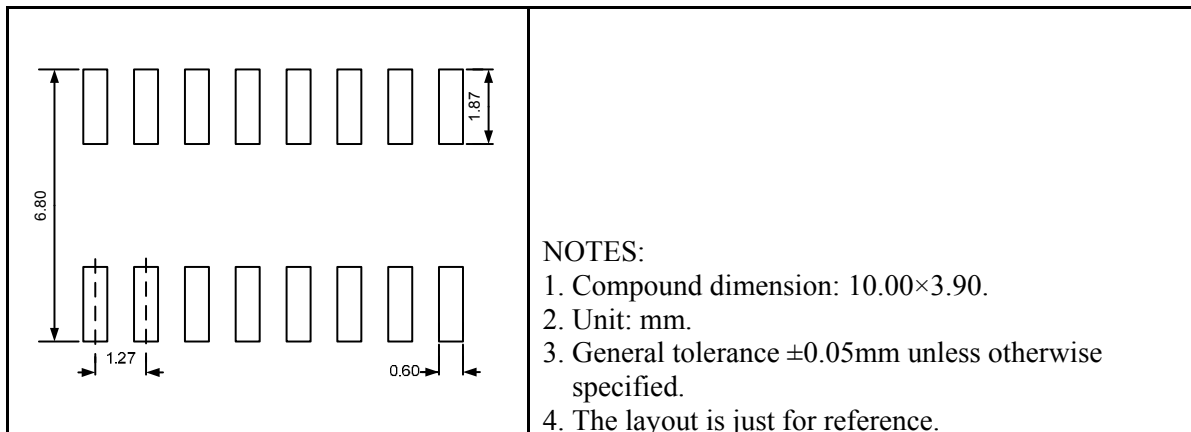

Tape and Reel Orientation

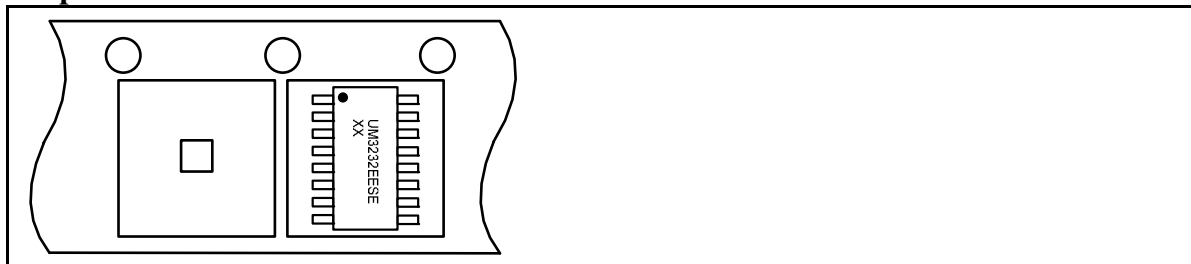

UM3232EEPE DIP16

Outline Drawing

DIMENSIONS						
Symbol	MILLIMETERS			INCHES		
	Min	Typ	Max	Min	Typ	Max
A	3.71	4.01	4.31	0.146	0.158	0.170
A1	0.51	-	-	0.020	-	-
A2	3.20	3.40	3.60	0.126	0.134	0.142
b	0.38	0.48	0.57	0.015	0.019	0.022
b1	1.52BSC			0.060BSC		
c	0.20	0.28	0.36	0.008	0.011	0.014
D	18.80	19.00	19.20	0.740	0.748	0.756
E	6.20	6.40	6.60	0.244	0.252	0.260
E1	7.32	7.62	7.92	0.288	0.300	0.312
E2	8.40	8.70	9.00	0.331	0.343	0.354
e	2.54BSC			0.100BSC		
L	3.00	3.30	3.60	0.118	0.130	0.142

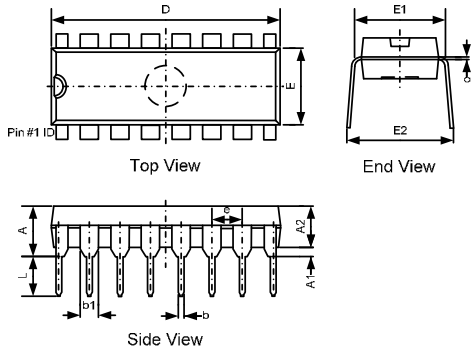

UM3221EEUE/UM3232EEUE TSSOP16

Outline Drawing

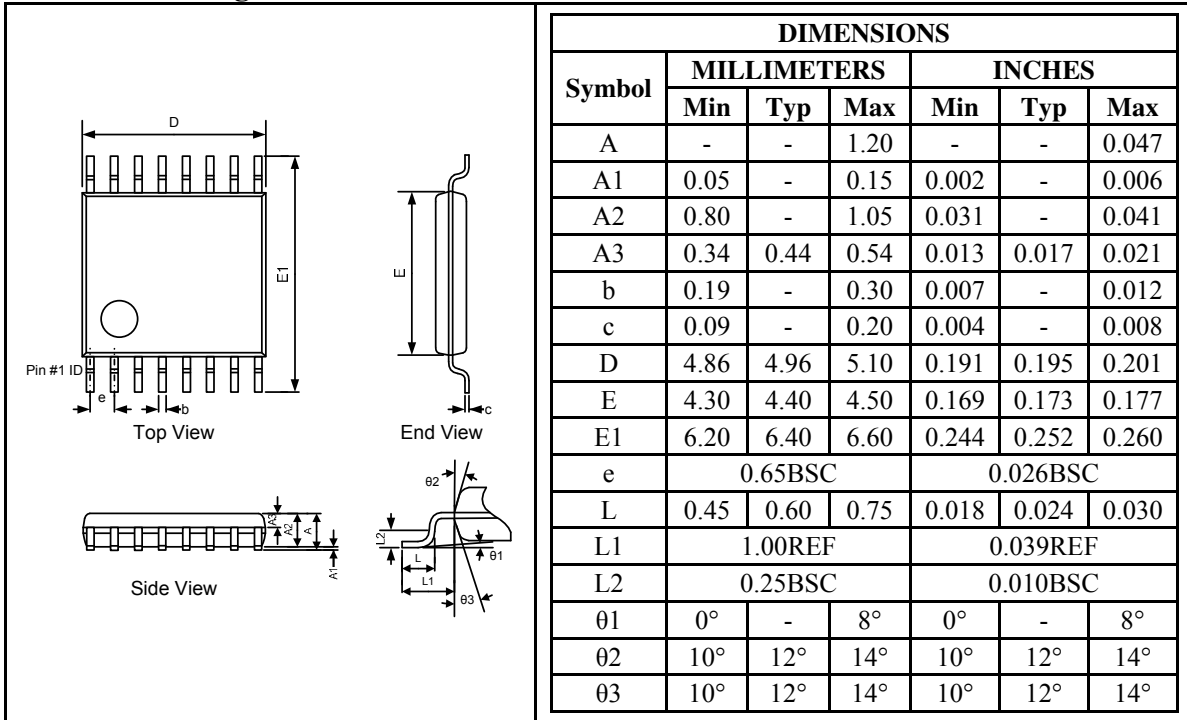

Land Pattern

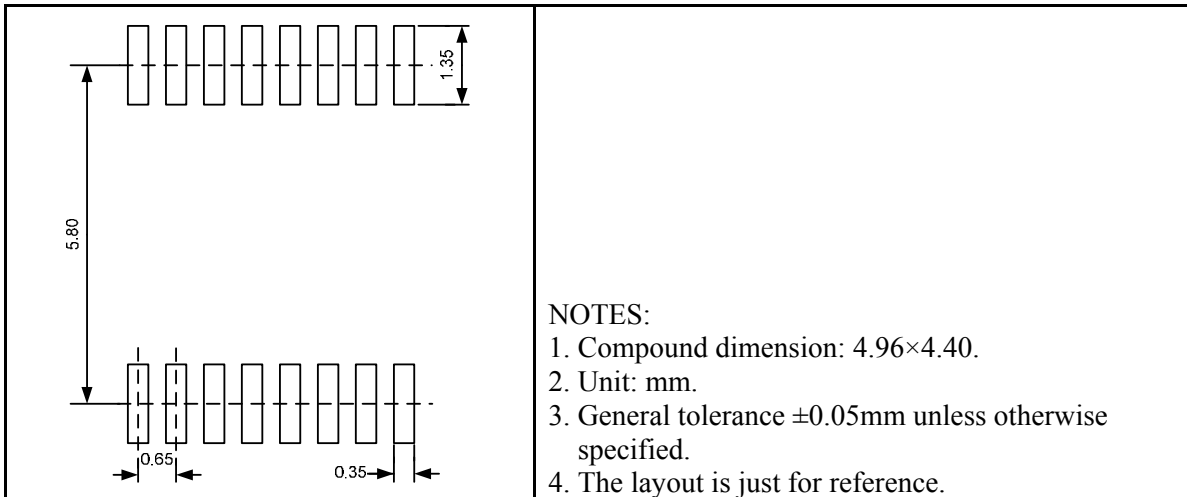

Tape and Reel Orientation

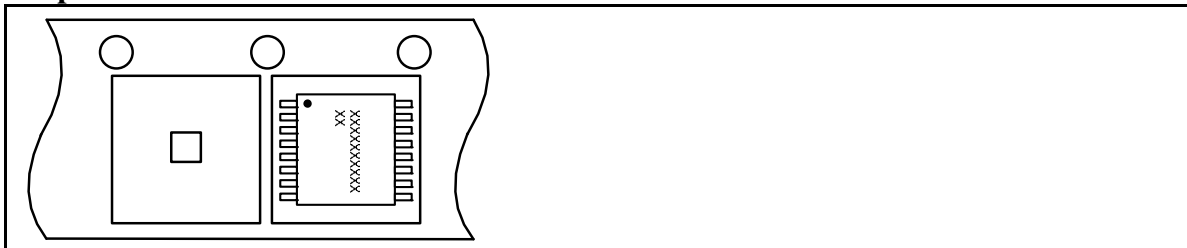

UM3222EEUE TSSOP20

Outline Drawing

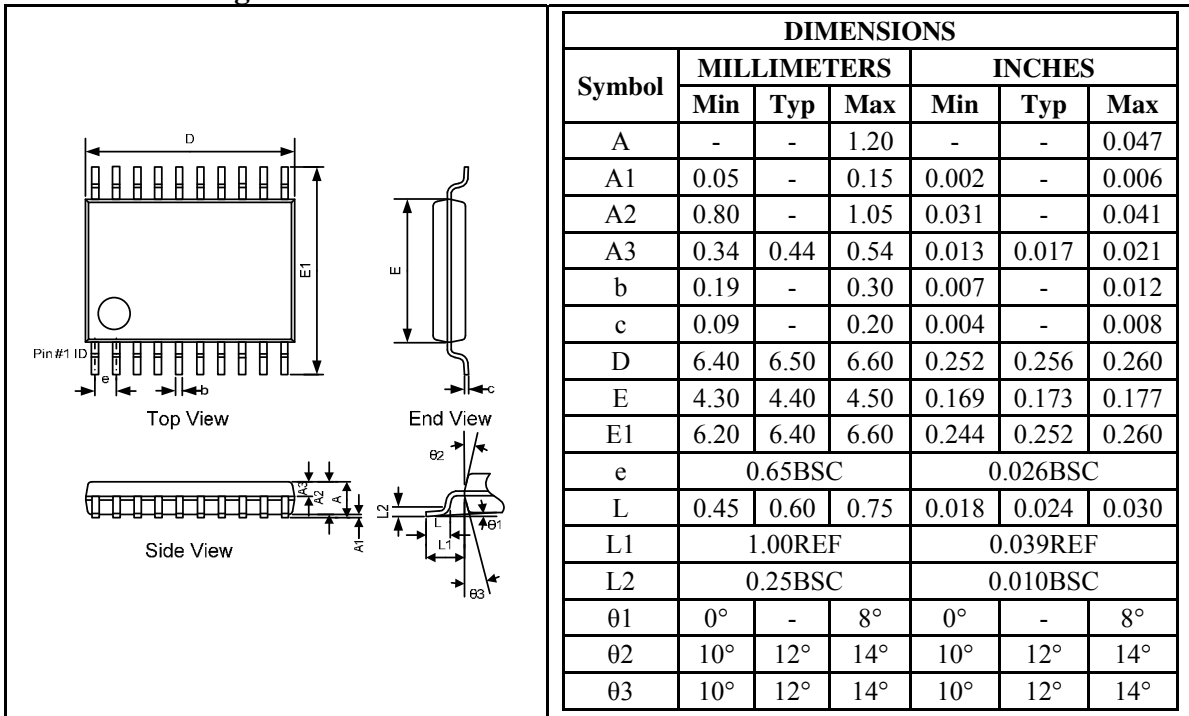

Land Pattern

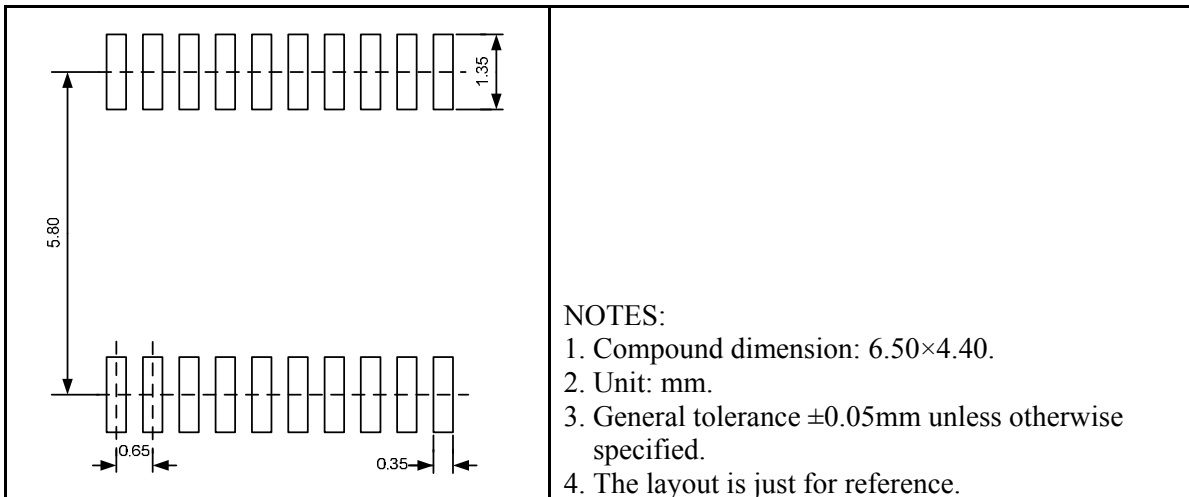

Tape and Reel Orientation

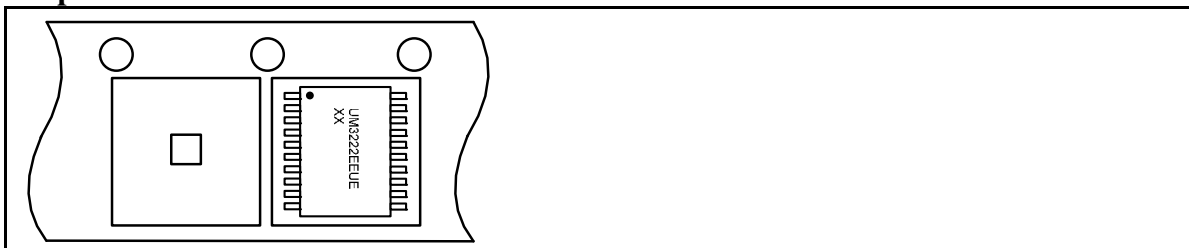

UM3221EEAE/UM3232EEAE SSOP16

Outline Drawing

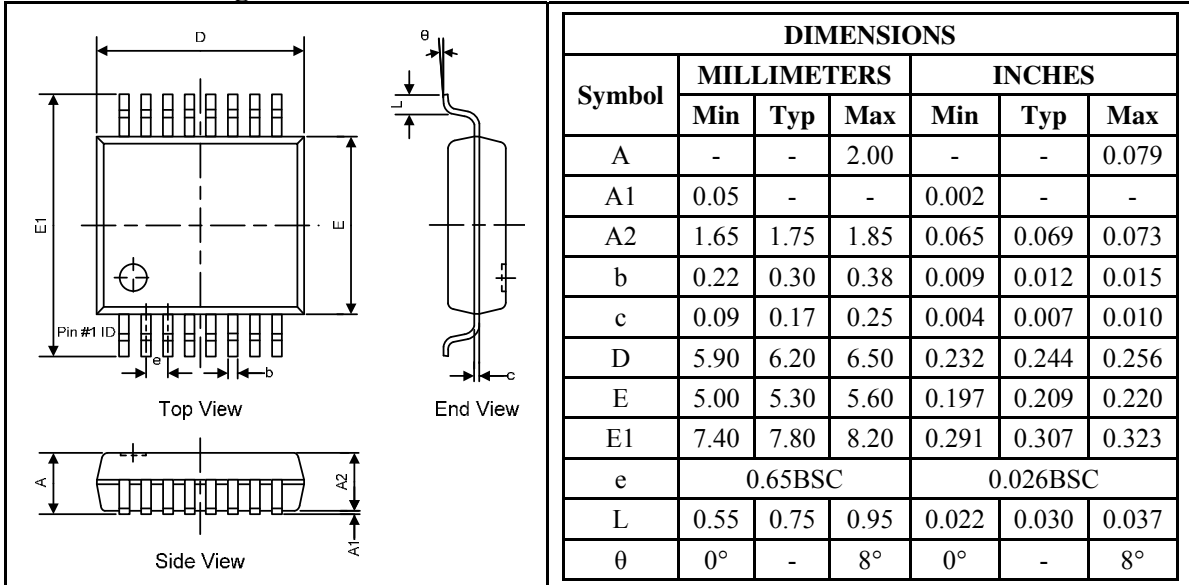

Land Pattern

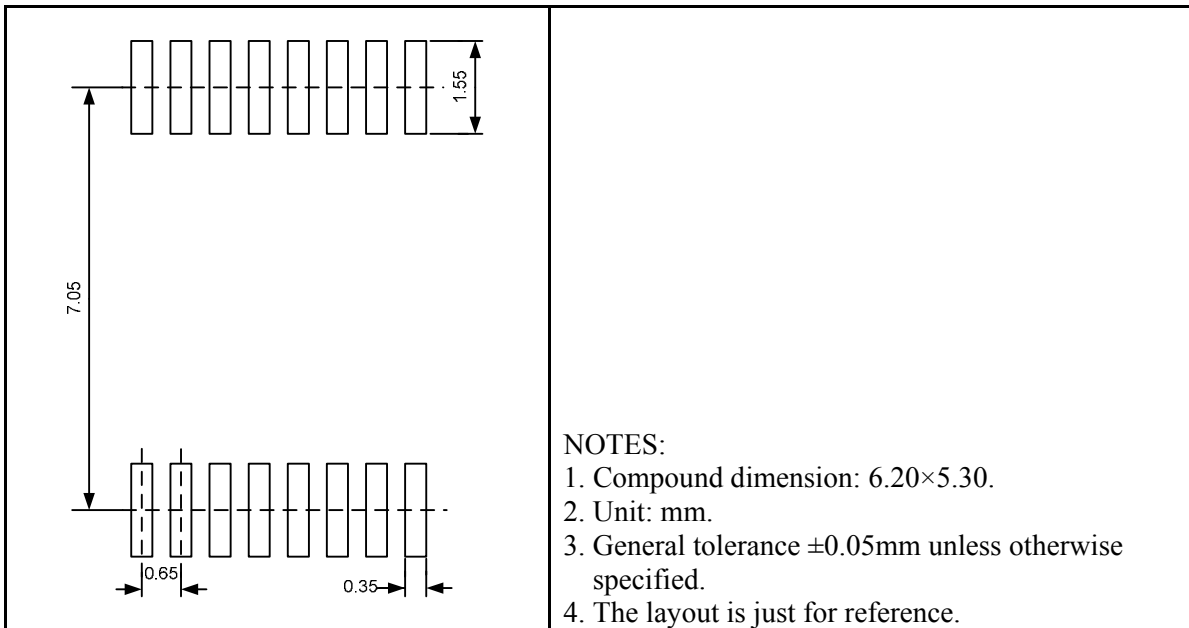

Tape and Reel Orientation

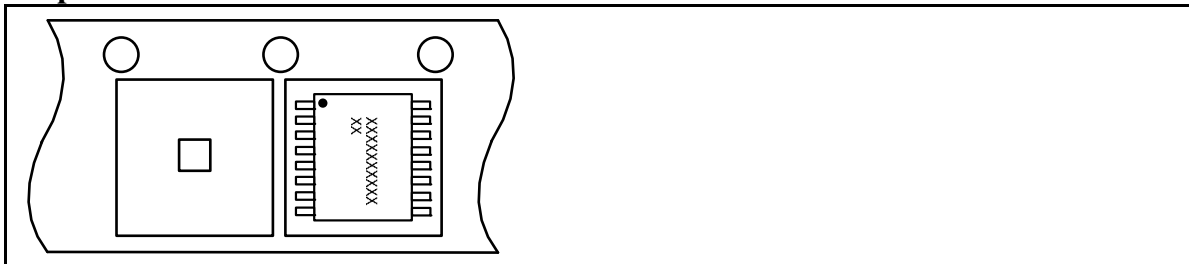

GREEN COMPLIANCE

Union Semiconductor is committed to environmental excellence in all aspects of its operations including meeting or exceeding regulatory requirements with respect to the use of hazardous substances. Numerous successful programs have been implemented to reduce the use of hazardous substances and/or emissions.

All Union components are compliant with the RoHS directive, which helps to support customers in their compliance with environmental directives. For more green compliance information, please visit:

http://www.union-ic.com/index.aspx?cat_code=RoHSDeclaration

IMPORTANT NOTICE

The information in this document has been carefully reviewed and is believed to be accurate. Nonetheless, this document is subject to change without notice. Union assumes no responsibility for any inaccuracies that may be contained in this document, and makes no commitment to update or to keep current the contained information, or to notify a person or organization of any update. Union reserves the right to make changes, at any time, in order to improve reliability, function or design and to attempt to supply the best product possible.