

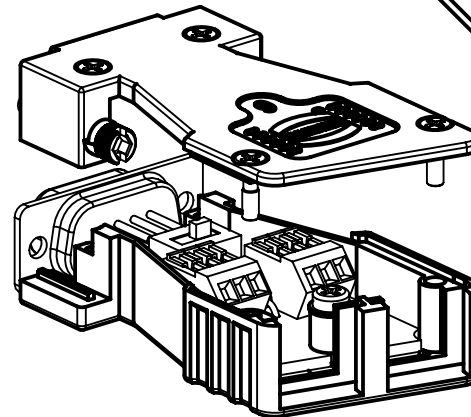

D-Sub 9 poles

CAN Interface Schematic

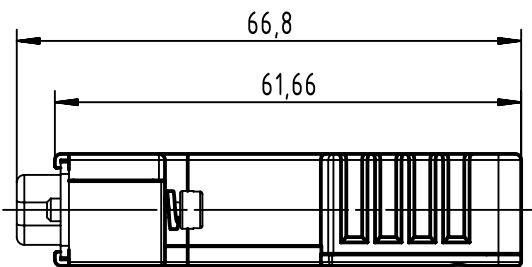
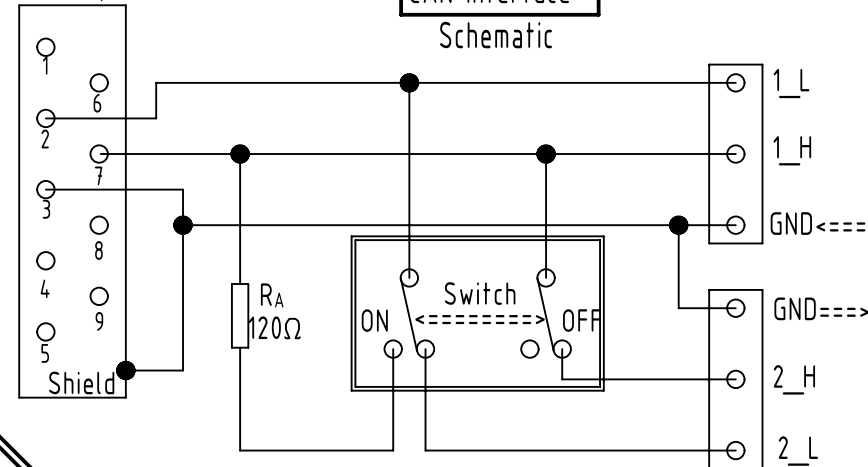

	All Dimensions in mm Original Size DIN A4		Scale 1:1	Free size tol.		Ref.	
	All rights reserved		Created by ZHUANGJ	Inspected by LUOK	Standardisation ROEBEN	Date 2021-11-11	State Final Release
Department EL PD		Title InduCom 9 Male CAN 4-40UNC				Doc-Key / ECM-Nr. 100073158/UGD/008/H 50000204.114	
HARTING D-32339 Espelkamp		Type TB	Number 66630095024			Rev. H	Page 1/1

6663 009 5024 777	PL1	Small batch
6663 009 5024	PL1	Standard batch
Part number	Performance level	Remark