



FEATURES

- Wideband, 10 to 1000 MHz
- Low mainline loss, 0.7 dB typ.
- Aqueous washable
- Leads for excellent solderability
- Protected by US Patent 6,140,887



Generic photo used for illustration purposes only

CASE STYLE: DB1627

APPLICATIONS

- VHF/UHF
- CATV
- Cellular

+RoHS Compliant

The +Suffix identifies RoHS Compliance.
See our website for methodologies and qualifications

ELECTRICAL SPECIFICATIONS AT 25°C

Parameter	Frequency (MHz)	Min.	Typ.	Max.	Unit
Frequency Range	—	10	—	1000	MHz
Mainline Loss ¹	10-100	—	0.9	1.3	dB
	100-500	—	0.7	1.2	
	500-1000	—	0.8	1.3	
Coupling	10-1000	—	18.0±0.5	—	dB
Coupling Flatness (±)	10-1000	—	±0.9	—	dB
Directivity	10-100	15	20	—	dB
	100-500	15	22	—	
	500-1000	—	18	—	
VSWR	10-1000	—	1.20	—	:1
Input Power	10-1000	—	—	1.0	W
	100-1000	—	—	1.0	

1. Mainline loss includes theoretical power loss at coupled port.

MAXIMUM RATINGS

Parameter	Ratings
Operating Temperature	-40°C to 85°C*
Storage Temperature	-55°C to 100°C

Permanent damage may occur if any of these limits are exceeded.

* Case temperature is defined as temperature on ground leads.

ELECTRICAL SCHEMATIC

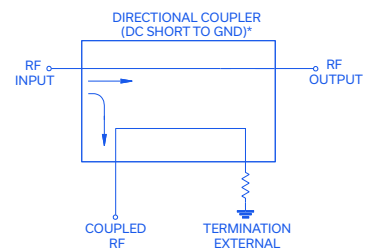

*Electrical schematic is for Directional coupler with internal transformer(s) and external termination



PIN CONNECTIONS

INPUT	3
OUTPUT	4
COUPLED	1
GROUND	2
75Ω TERM EXTERNAL	6
NOT USED	5

PRODUCT MARKING: DG

**DEMO BOARD MCL P/N: TB-72
SUGGESTED PCB LAYOUT (PL-010)**

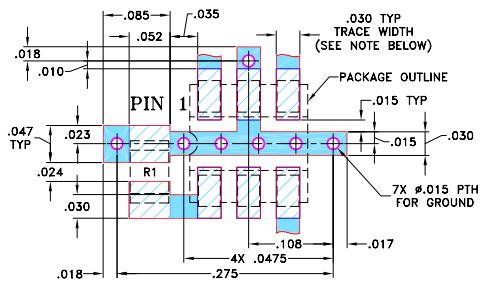

RESISTOR R1: 75 ± 1% Ohm, 0805 SIZE

- NOTES:**
- TRACE WIDTH IS SHOWN FOR ROGERS RO4350B WITH DIELECTRIC THICKNESS 0.030" ± 0.002"; COPPER: 1/2 OZ. EACH SIDE. FOR OTHER MATERIALS TRACE WIDTH MAY NEED TO BE MODIFIED.
 - BOTTOM SIDE OF THE PCB IS CONTINUOUS GROUND PLANE.

- DENOTES PCB COPPER LAYOUT WITH SMOBC (SOLDER MASK OVER BARE COPPER)
- DENOTES COPPER LAND PATTERN FREE OF SOLDER MASK

OUTLINE DRAWING

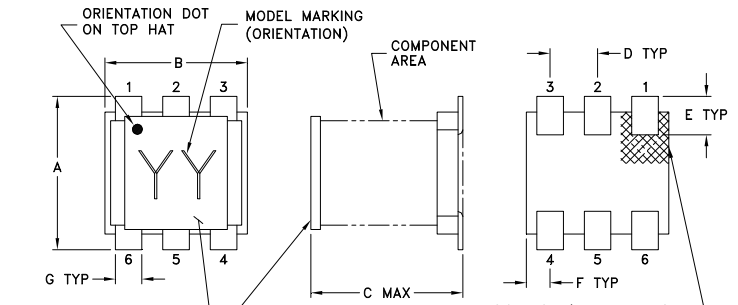

TOP-HAT / PICK & PLACE SURFACE AREA (10X.10) MIN
TOP-HAT TOTAL THICKNESS: .013 inches MAX.

Orientation dot on Top-Hat & orientation feature on substrate corresponds to pin #1.

PCB Land Pattern

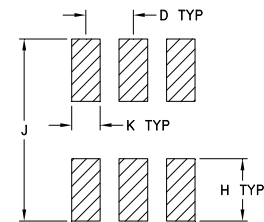

SUGGESTED LAYOUT TOLERANCE TO BE WITHIN ±.002

OUTLINE DIMENSIONS (Inches mm)

A	B	C	D	E	F
.160	.150	.160	.050	.040	.025
4.06	3.81	4.06	1.27	1.02	0.64
G	H	J	K		wt
.028	.065	.190	.030		grams
0.71	1.65	4.83	0.76		0.15

TAPE & REEL INFORMATION: F47



Directional Coupler

TCD-18-4-75X+

75Ω

10 to 1000 MHz

TYPICAL PERFORMANCE DATA

Frequency (MHz)	Mainline Loss (dB)		Coupling (dB)	Directivity (dB)	Return Loss (dB)		
	In-Out	In-Cpl			In	Out	Cpl
10.00	0.80	18.25	24.89	19.65	21.19	19.31	
30.00	0.75	18.09	28.81	21.21	23.47	21.05	
50.00	0.75	18.07	29.10	21.46	23.88	21.36	
90.00	0.75	18.05	28.90	21.60	23.98	21.20	
100.00	0.75	18.05	28.77	21.62	23.96	21.20	
300.00	0.73	18.00	25.91	21.12	23.00	22.63	
500.00	0.75	17.87	23.32	20.19	21.20	25.64	
700.00	0.75	17.64	21.87	20.17	20.48	28.73	
900.00	0.79	17.44	21.22	21.04	20.47	32.11	
1000.00	0.81	17.34	21.19	21.96	20.60	31.73	

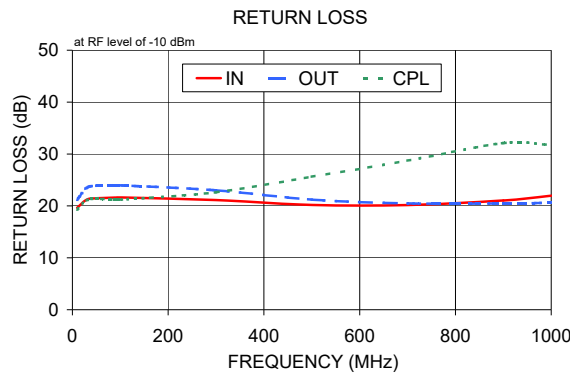
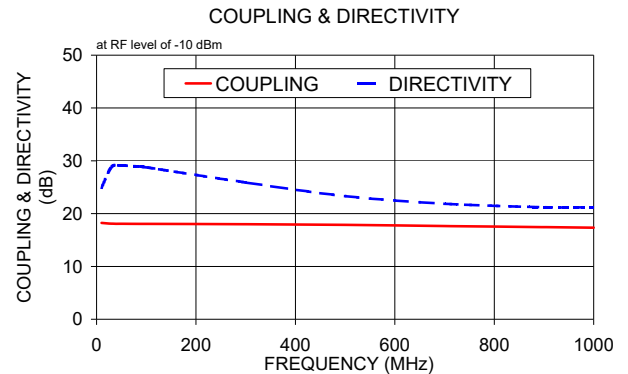
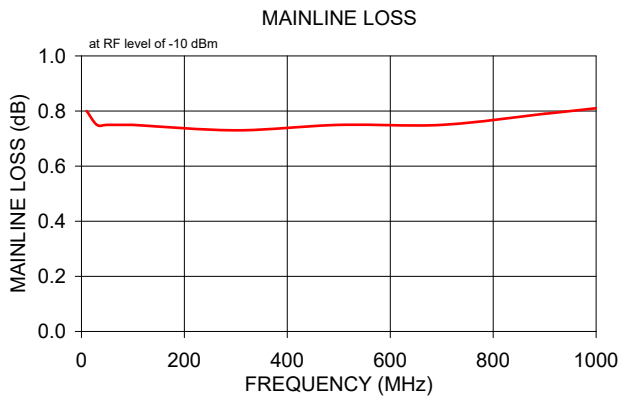

- NOTES**
- A. Performance and quality attributes and conditions not expressly stated in this specification document are intended to be excluded and do not form a part of this specification document.
 - B. Electrical specifications and performance data contained in this specification document are based on Mini-Circuit's applicable established test performance criteria and measurement instructions.
 - C. The parts covered by this specification document are subject to Mini-Circuits standard limited warranty and terms and conditions (collectively, "Standard Terms"); Purchasers of this part are entitled to the rights and benefits contained therein. For a full statement of the standard. Terms and the exclusive rights and remedies thereunder, please visit Mini-Circuits' website at www.minicircuits.com/terms/viewterm.html