

N-Channel 30 V (D-S) MOSFET With Schottky Diode

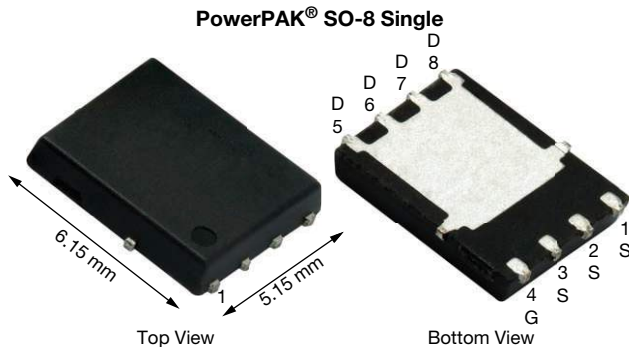

RoHS
COMPLIANT
HALOGEN
FREE



FEATURES

- TrenchFET® Gen IV power MOSFET
- SkyFET® with monolithic Schottky diode
- Optimized $R_{DS} \times Q_g$ and $R_{DS} \times Q_{gd}$ FOM elevates efficiency for high-frequency switching
- 100 % R_g and UIS tested
- Material categorization: for definitions of compliance please see www.vishay.com/doc?99912

APPLICATIONS

- Synchronous buck
- Synchronous rectification
- DC/DC conversion

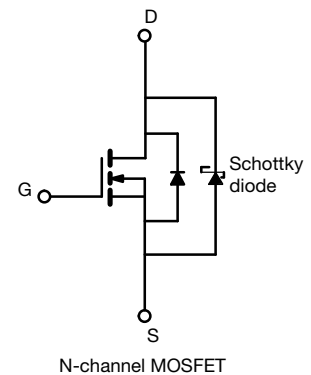

PRODUCT SUMMARY	
MOSFET	
V_{DS} (V)	30
$R_{DS(on)}$ max. (Ω) at $V_{GS} = 10$ V	0.00110
$R_{DS(on)}$ max. (Ω) at $V_{GS} = 4.5$ V	0.00154
Q_g typ. (nC)	35
I_D (A) ^{a, g}	60
SCHOTTKY	
V_F (V) at 10 A	0.55
I_F (A) ^{a, g}	60
Configuration	Single plus integrated Schottky

ORDERING INFORMATION	
Package	PowerPAK SO-8
Lead (Pb)-free and halogen-free	SiRC18DP-T1-GE3

ABSOLUTE MAXIMUM RATINGS ($T_A = 25$ °C, unless otherwise noted)			
PARAMETER	SYMBOL	LIMIT	UNIT
Drain-source voltage	V_{DS}	30	V
Gate-source voltage	V_{GS}	+20, -16	
Continuous drain current ($T_J = 150$ °C)	I_D	$T_C = 25$ °C	60 ^a
		$T_C = 70$ °C	60 ^a
		$T_A = 25$ °C	52 ^{b, c}
		$T_A = 70$ °C	42 ^{b, c}
Pulsed drain current ($t = 100$ μ s)	I_{DM}	250	A
Continuous source current (MOSFET diode conduction)	I_S	$T_C = 25$ °C	
		$T_A = 25$ °C	5 ^{a, b}
Single pulse avalanche current	I_{AS}	30	mJ
Single pulse avalanche energy	E_{AS}	45	
Maximum power dissipation	P_D	$T_C = 25$ °C	54.3
		$T_C = 70$ °C	34.7
		$T_A = 25$ °C	5 ^{b, c}
		$T_A = 70$ °C	3.2 ^{b, c}
Operating junction and storage temperature range	T_J, T_{stg}	-55 to +150	°C
Soldering recommendations (peak temperature)		260	



THERMAL RESISTANCE RATINGS					
PARAMETER		SYMBOL	TYPICAL	MAXIMUM	UNIT
Maximum junction-to-ambient ^{b, f}	$t \leq 10$ s	R_{thJA}	20	25	°C/W
Maximum junction-to-case (drain)	Steady state	R_{thJC}	1.8	2.3	

Notes

- Package limited
- Surface mounted on 1" x 1" FR4 board
- $t = 10$ s
- See solder profile (www.vishay.com/doc?73257). The PowerPAK SO-8 is a leadless package. The end of the lead terminal is exposed copper (not plated) as a result of the singulation process in manufacturing. A solder fillet at the exposed copper tip cannot be guaranteed and is not required to ensure adequate bottom side solder interconnection
- Rework conditions: manual soldering with a soldering iron is not recommended for leadless components
- Maximum under steady state conditions is 65 °C/W
- $T_C = 25$ °C

SPECIFICATIONS ($T_J = 25$ °C, unless otherwise noted)							
PARAMETER	SYMBOL	TEST CONDITIONS	MIN.	TYP.	MAX.	UNIT	
Static							
Drain-source breakdown voltage	V_{DS}	$V_{GS} = 0$ V, $I_D = 250$ μ A	30	-	-	V	
Gate-source threshold voltage	$V_{GS(th)}$	$V_{DS} = V_{GS}$, $I_D = 250$ μ A	1	-	2.4		
Gate-source leakage	I_{GSS}	$V_{DS} = 0$ V, $V_{GS} = +20$ V, -16 V	-	-	± 100	nA	
Zero gate voltage drain current	I_{DSS}	$V_{DS} = 30$ V, $V_{GS} = 0$ V	-	0.06	0.20	mA	
		$V_{DS} = 30$ V, $V_{GS} = 0$ V, $T_J = 70$ °C	-	1	10		
On-state drain current ^a	$I_{D(on)}$	$V_{DS} \geq 5$ V, $V_{GS} = 10$ V	40	-	-	A	
Drain-source on-state resistance ^a	$R_{DS(on)}$	$V_{GS} = 10$ V, $I_D = 15$ A	-	0.00085	0.00110	Ω	
		$V_{GS} = 4.5$ V, $I_D = 10$ A	-	0.00135	0.00154		
Forward transconductance ^a	g_{fs}	$V_{DS} = 10$ V, $I_D = 15$ A	-	70	-	S	
Dynamic^b							
Input capacitance	C_{iss}	$V_{DS} = 15$ V, $V_{GS} = 0$ V, $f = 1$ MHz	-	5060	-	pF	
Output capacitance	C_{oss}		-	2400	-		
Reverse transfer capacitance	C_{rss}		-	350	-		
C_{rss}/C_{iss} ratio			-	0.069	0.140		
Total gate charge	Q_g	$V_{DS} = 15$ V, $V_{GS} = 10$ V, $I_D = 10$ A	-	74	111	nC	
Gate-source charge	Q_{gs}	$V_{DS} = 15$ V, $V_{GS} = 4.5$ V, $I_D = 10$ A	-	35	53		
Gate-drain charge	Q_{gd}		-	11.8	-		
Gate resistance	R_g		$f = 1$ MHz	0.1	0.5		0.9
Turn-on delay time	$t_{d(on)}$	$V_{DD} = 15$ V, $R_L = 1.5$ Ω , $I_D \cong 10$ A, $V_{GEN} = 10$ V, $R_g = 1$ Ω	-	16	32	ns	
Rise time	t_r		-	21	42		
Turn-off delay time	$t_{d(off)}$		-	30	60		
Fall time	t_f		-	12	24		
Turn-on delay time	$t_{d(on)}$		$V_{DD} = 15$ V, $R_L = 1.5$ Ω , $I_D \cong 10$ A, $V_{GEN} = 4.5$ V, $R_g = 1$ Ω	-	31		62
Rise time	t_r			-	77		154
Turn-off delay time	$t_{d(off)}$	-		38	76		
Fall time	t_f	-		37	74		
Drain-source Body Diode Characteristics							
Continuous source-drain diode current	I_S	$T_C = 25$ °C	-	-	60	A	
Pulse diode forward current	I_{SM}		-	-	100		
Body diode voltage	V_{SD}	$I_S = 5$ A, $V_{GS} = 0$ V	-	0.41	0.55	V	
Body diode reverse recovery time	t_{rr}	$I_F = 10$ A, $di/dt = 100$ A/ μ s, $T_J = 25$ °C	-	58	116	ns	
Body diode reverse recovery charge	Q_{rr}		-	72	144	nC	
Reverse recovery fall time	t_a		-	26	-	ns	
Reverse recovery rise time	t_b		-	32	-		

Notes

- Pulse test; pulse width ≤ 300 μ s, duty cycle ≤ 2 %
- Guaranteed by design, not subject to production testing

Stresses beyond those listed under "Absolute Maximum Ratings" may cause permanent damage to the device. These are stress ratings only, and functional operation of the device at these or any other conditions beyond those indicated in the operational sections of the specifications is not implied. Exposure to absolute maximum rating conditions for extended periods may affect device reliability.

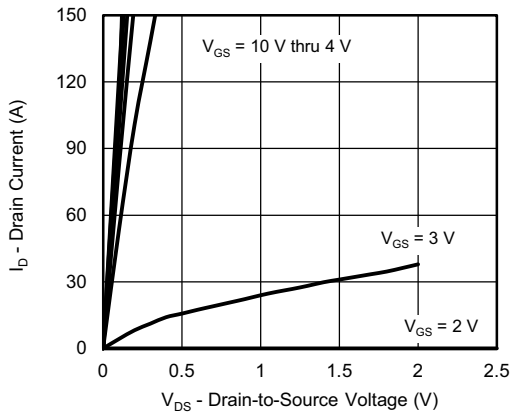
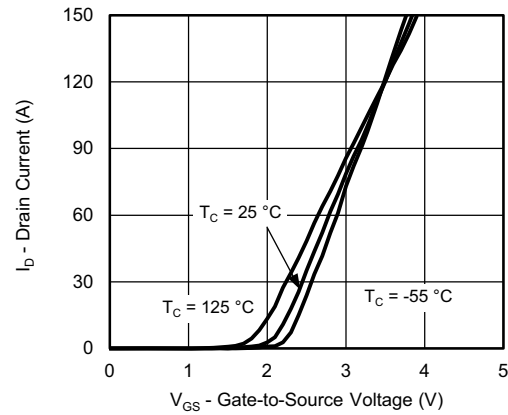
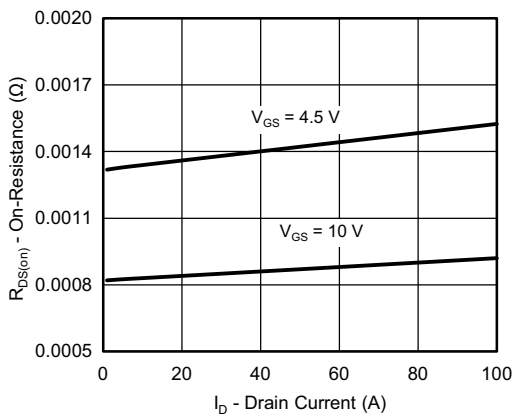
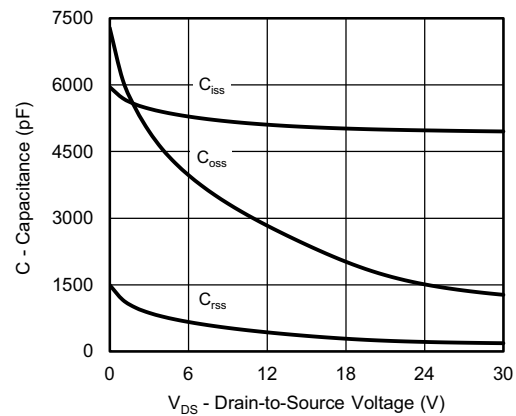
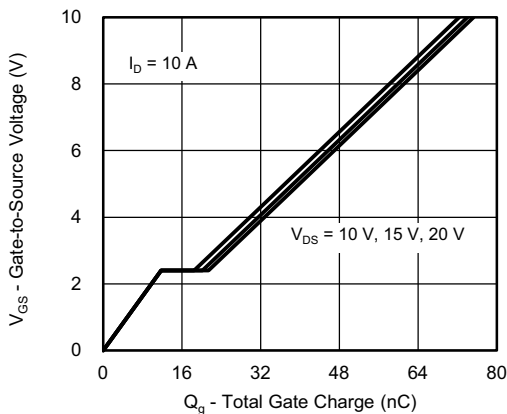
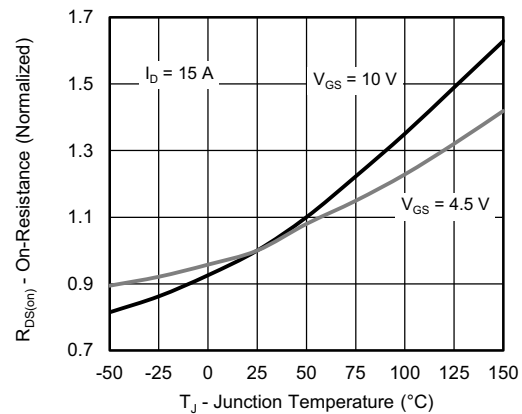
TYPICAL CHARACTERISTICS (25 °C, unless otherwise noted)

Output Characteristics

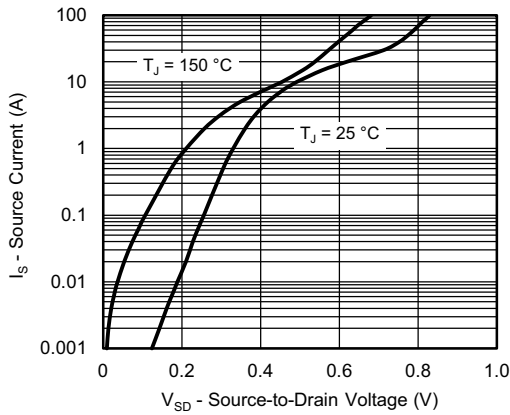
Transfer Characteristics

On-Resistance vs. Drain Current and Gate

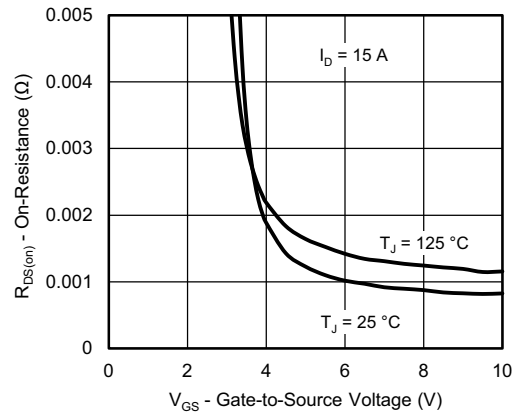
Capacitance

Gate Charge

On-Resistance vs. Junction Temperature

TYPICAL CHARACTERISTICS (25 °C, unless otherwise noted)



Source-Drain Diode Forward Voltage



On-Resistance vs. Gate-to-Source Voltage

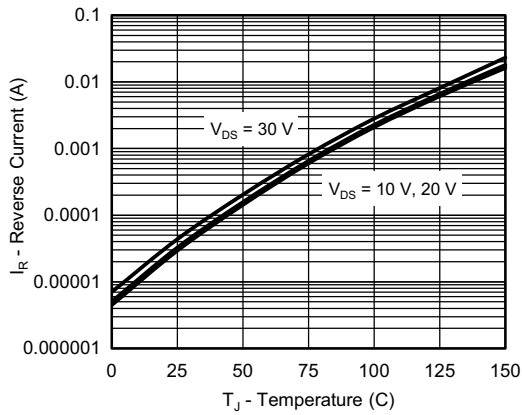

Reverse Current vs. Junction Temperature

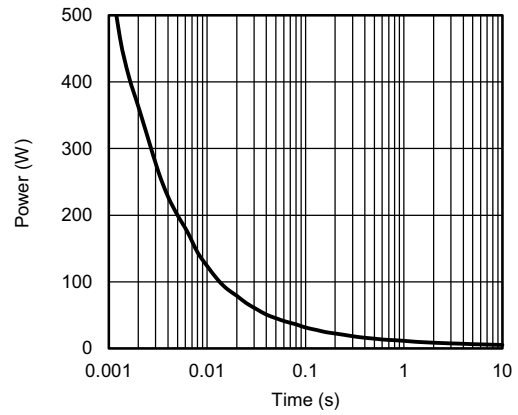

Single Pulse Power

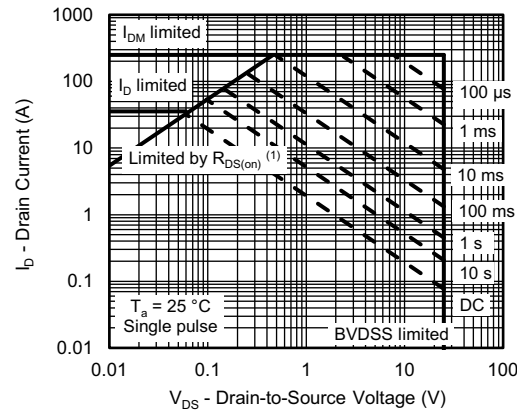

(1) $V_{GS} >$ minimum V_{GS} at which $R_{DS(on)}$ is specified

Safe Operating Area, Junction-to-Ambient



TYPICAL CHARACTERISTICS (25 °C, unless otherwise noted)

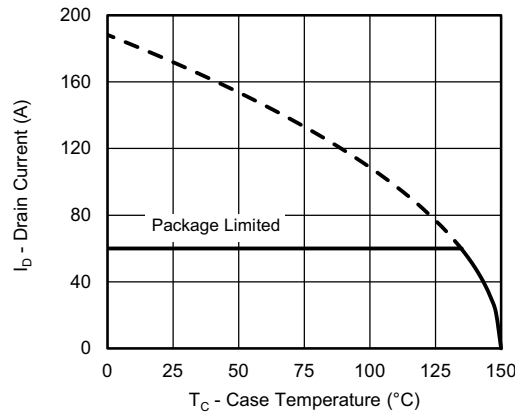

Current Derating ^a

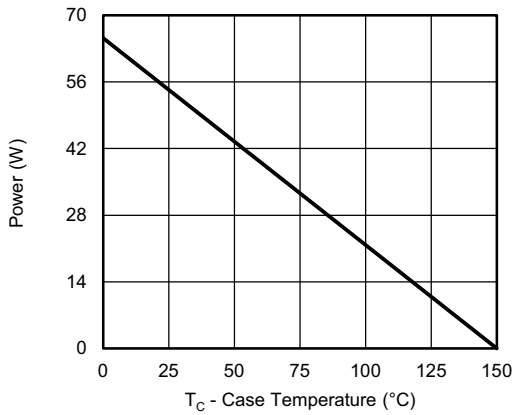

Power, Junction-to-Case

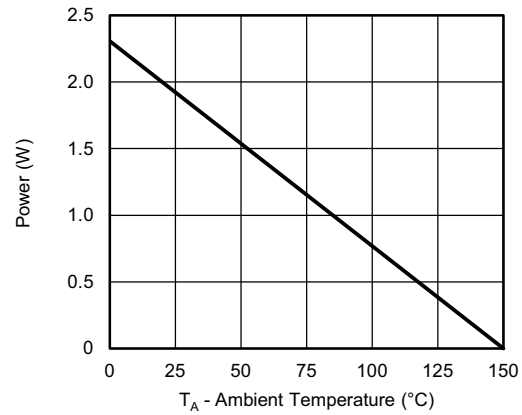

Power, Junction-to-Ambient

Note

- a. The power dissipation P_D is based on T_J max. = 150 °C, using junction-to-case thermal resistance, and is more useful in settling the upper dissipation limit for cases where additional heatsinking is used. It is used to determine the current rating, when this rating falls below the package limit.

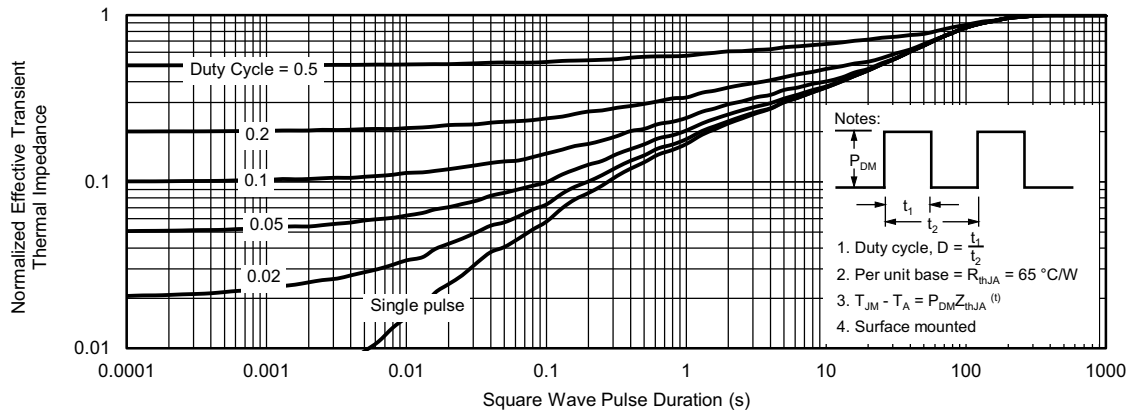
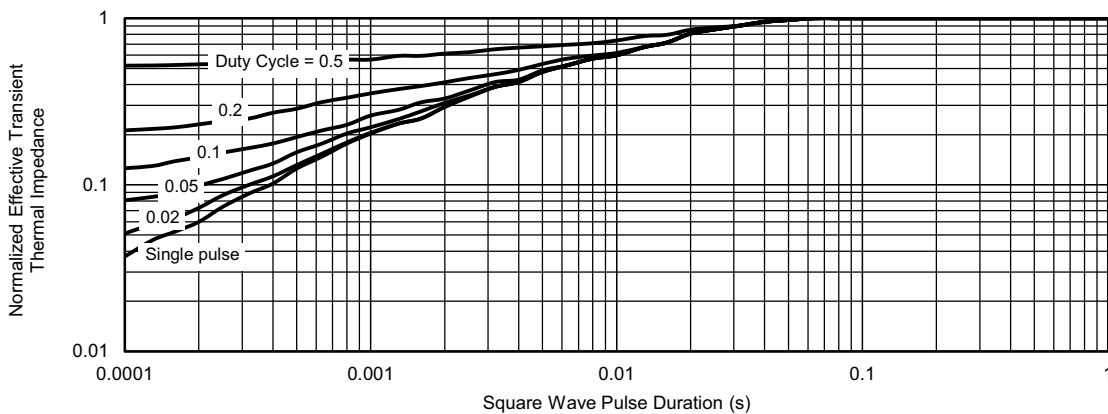
TYPICAL CHARACTERISTICS (25 °C, unless otherwise noted)

Normalized Thermal Transient Impedance, Junction-to-Ambient

Normalized Thermal Transient Impedance, Junction-to-Case

Vishay Siliconix maintains worldwide manufacturing capability. Products may be manufactured at one of several qualified locations. Reliability data for Silicon Technology and Package Reliability represent a composite of all qualified locations. For related documents such as package / tape drawings, part marking, and reliability data, see www.vishay.com/ppg?76402.



PowerPAK[®] SO-8, (Single/Dual)



DIM.	MILLIMETERS			INCHES		
	MIN.	NOM.	MAX.	MIN.	NOM.	MAX.
A	0.97	1.04	1.12	0.038	0.041	0.044
A1		-	0.05	0	-	0.002
b	0.33	0.41	0.51	0.013	0.016	0.020
c	0.23	0.28	0.33	0.009	0.011	0.013
D	5.05	5.15	5.26	0.199	0.203	0.207
D1	4.80	4.90	5.00	0.189	0.193	0.197
D2	3.56	3.76	3.91	0.140	0.148	0.154
D3	1.32	1.50	1.68	0.052	0.059	0.066
D4	0.57 typ.			0.0225 typ.		
D5	3.98 typ.			0.157 typ.		
E	6.05	6.15	6.25	0.238	0.242	0.246
E1	5.79	5.89	5.99	0.228	0.232	0.236
E2	3.48	3.66	3.84	0.137	0.144	0.151
E3	3.68	3.78	3.91	0.145	0.149	0.154
E4	0.75 typ.			0.030 typ.		
e	1.27 BSC			0.050 BSC		
K	1.27 typ.			0.050 typ.		
K1	0.56	-	-	0.022	-	-
H	0.51	0.61	0.71	0.020	0.024	0.028
L	0.51	0.61	0.71	0.020	0.024	0.028
L1	0.06	0.13	0.20	0.002	0.005	0.008
θ	0°	-	12°	0°	-	12°
W	0.15	0.25	0.36	0.006	0.010	0.014
M	0.125 typ.			0.005 typ.		
ECN: S17-0173-Rev. L, 13-Feb-17						
DWG: 5881						

RECOMMENDED MINIMUM PADS FOR PowerPAK® SO-8 Single

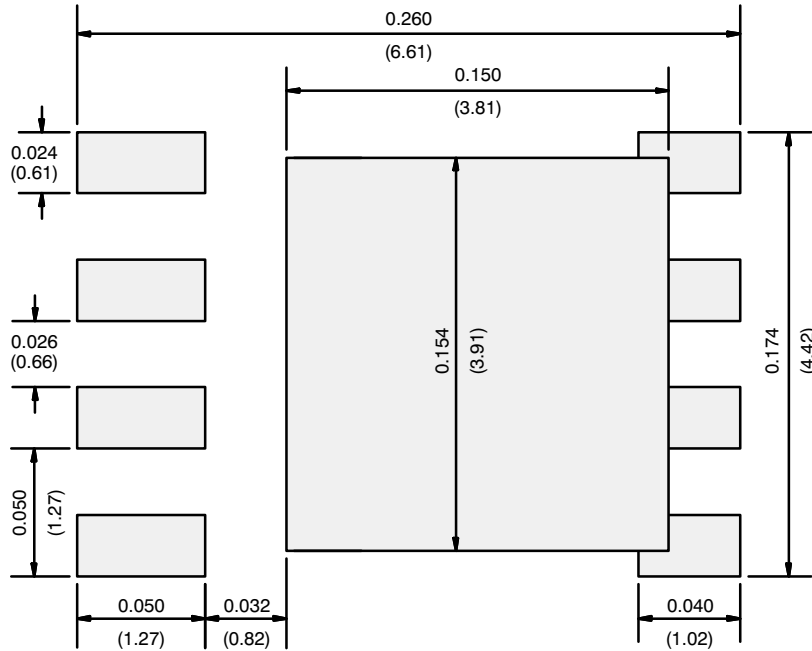

Recommended Minimum Pads
Dimensions in Inches/(mm)

[Return to Index](#)



Disclaimer

ALL PRODUCT, PRODUCT SPECIFICATIONS AND DATA ARE SUBJECT TO CHANGE WITHOUT NOTICE TO IMPROVE RELIABILITY, FUNCTION OR DESIGN OR OTHERWISE.

Vishay Intertechnology, Inc., its affiliates, agents, and employees, and all persons acting on its or their behalf (collectively, "Vishay"), disclaim any and all liability for any errors, inaccuracies or incompleteness contained in any datasheet or in any other disclosure relating to any product.

Vishay makes no warranty, representation or guarantee regarding the suitability of the products for any particular purpose or the continuing production of any product. To the maximum extent permitted by applicable law, Vishay disclaims (i) any and all liability arising out of the application or use of any product, (ii) any and all liability, including without limitation special, consequential or incidental damages, and (iii) any and all implied warranties, including warranties of fitness for particular purpose, non-infringement and merchantability.

Statements regarding the suitability of products for certain types of applications are based on Vishay's knowledge of typical requirements that are often placed on Vishay products in generic applications. Such statements are not binding statements about the suitability of products for a particular application. It is the customer's responsibility to validate that a particular product with the properties described in the product specification is suitable for use in a particular application. Parameters provided in datasheets and / or specifications may vary in different applications and performance may vary over time. All operating parameters, including typical parameters, must be validated for each customer application by the customer's technical experts. Product specifications do not expand or otherwise modify Vishay's terms and conditions of purchase, including but not limited to the warranty expressed therein.

Hyperlinks included in this datasheet may direct users to third-party websites. These links are provided as a convenience and for informational purposes only. Inclusion of these hyperlinks does not constitute an endorsement or an approval by Vishay of any of the products, services or opinions of the corporation, organization or individual associated with the third-party website. Vishay disclaims any and all liability and bears no responsibility for the accuracy, legality or content of the third-party website or for that of subsequent links.

Except as expressly indicated in writing, Vishay products are not designed for use in medical, life-saving, or life-sustaining applications or for any other application in which the failure of the Vishay product could result in personal injury or death. Customers using or selling Vishay products not expressly indicated for use in such applications do so at their own risk. Please contact authorized Vishay personnel to obtain written terms and conditions regarding products designed for such applications.

No license, express or implied, by estoppel or otherwise, to any intellectual property rights is granted by this document or by any conduct of Vishay. Product names and markings noted herein may be trademarks of their respective owners.