

CPDTR055V0C-HF

RoHS Device
Halogen Free

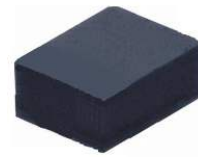

Features

- Bi-directional ESD protection of 4 lines.
- Operating voltage: 5V.

Mechanical data

- Case: SOT-23F-5P standard package, molded plastic.
- Terminals: Gold plated, solderable per MIL-STD-750D, method 2026.
- Marking code: E05
- Mounting position: Any.
- Weight: 0.012 gram(approx.).

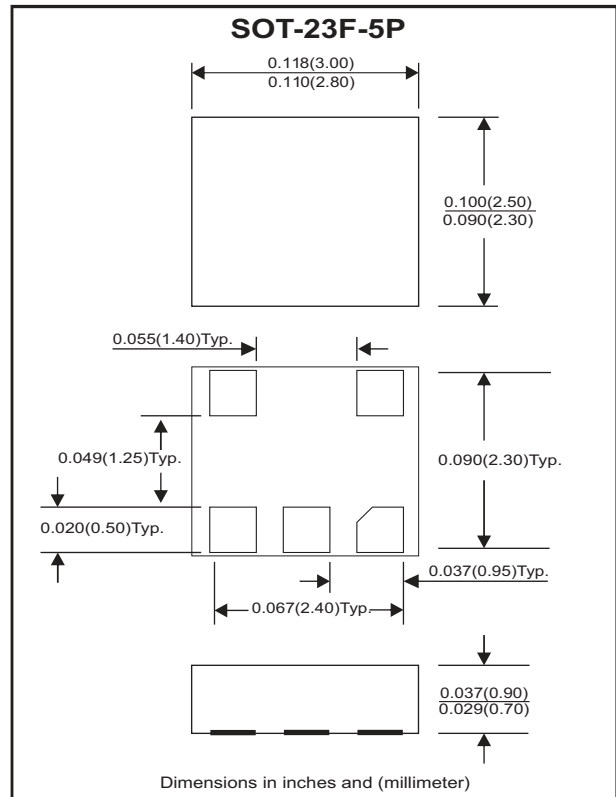
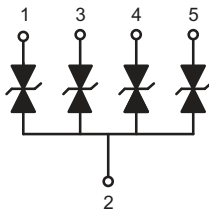

Electrical Characteristics (at TA=25 °C unless otherwise noted)

Parameter	Conditions	Symbol	Min	Typ	Max	Unit
Diode breakdown voltage	$I_R = 1\text{mA}$	V_{BD}	6.1	7.0		V
Leakage current	$V_R = 5\text{V}$	I_L		0.1	2.0	μA
Junction capacitance	$V_R = 0\text{V}, f = 1\text{MHz}$	C_T		25	30	pF
ESD capability	IEC 61000-4-2(air) IEC 61000-4-2(contact)	ESD			16 8	kV
Operation temperature		T_j			125	$^{\circ}\text{C}$
Storage temperature		T_{STG}	-55		150	$^{\circ}\text{C}$

RATING AND CHARACTERISTIC CURVES (CPDTR055V0C-HF)

Fig. 1 - Reverse characteristics

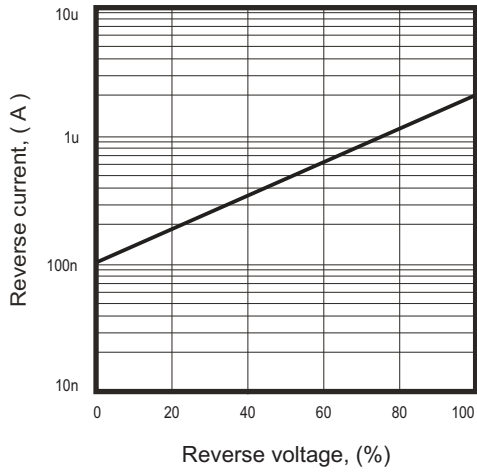

Fig. 2 - Capacitance between terminals characteristics

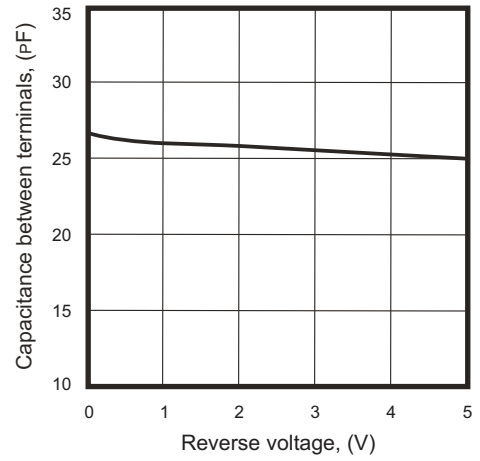
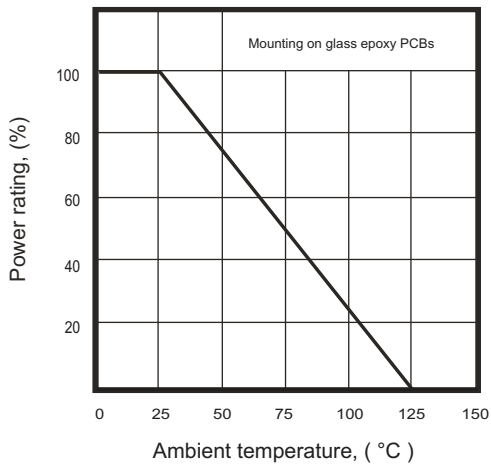
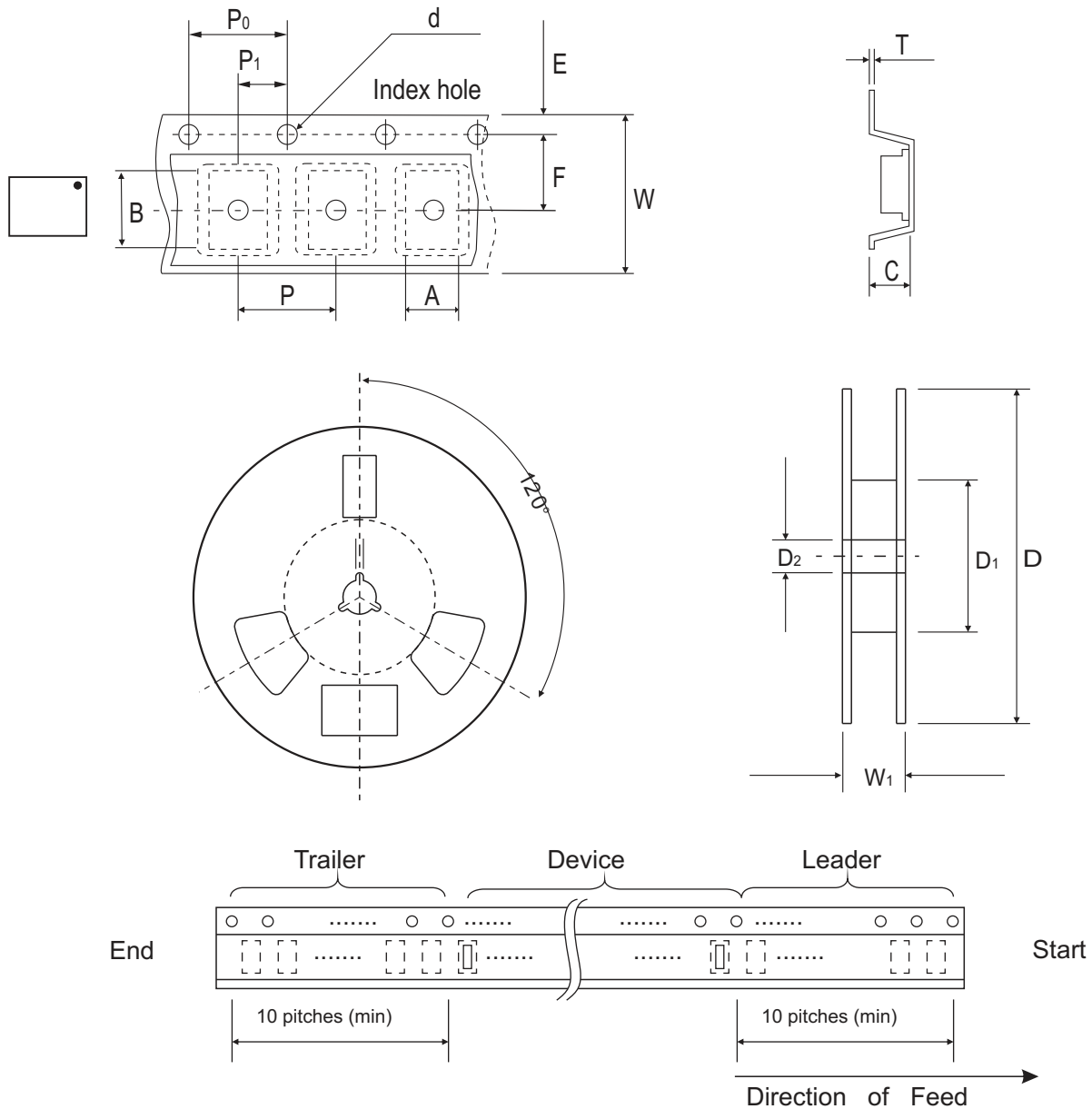

Fig. 3 - Power rating derating curve



Reel Taping Specification



SOT-23F-5P	SYMBOL	A	B	C	d	D	D ₁	D ₂
	(mm)	3.15 ± 0.10	2.65 ± 0.10	0.95 ± 0.10	1.55 ± 0.10	178 ± 1	60.0 MIN.	13.0 ± 0.20
	(inch)	0.124 ± 0.004	0.104 ± 0.004	0.037 ± 0.004	0.061 ± 0.004	7.008 ± 0.04	2.362 MIN.	0.512 ± 0.008

SOT-23F-5P	SYMBOL	E	F	P	P ₀	P ₁	T	W	W ₁
	(mm)	1.75 ± 0.10	3.50 ± 0.05	4.00 ± 0.10	4.00 ± 0.10	2.00 ± 0.10	0.22 ± 0.05	8.00 ± 0.20	13.5 MAX.
	(inch)	0.069 ± 0.004	0.138 ± 0.002	0.157 ± 0.004	0.157 ± 0.004	0.079 ± 0.004	0.009 ± 0.002	0.315 ± 0.008	0.531 MAX.

Marking Code

Part Number	Marking Code
CPDTR055V0C-HF	E05

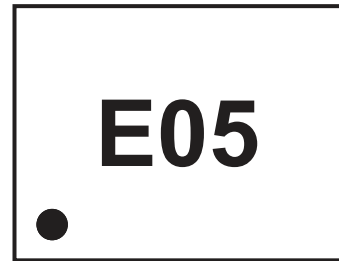

Suggested PAD Layout

SIZE	SOT-23F-5P	
	(mm)	(inch)
A	1.90	0.075
B	1.10	0.043
C	0.90	0.035
D	1.70	0.067
E	0.80	0.031
F	0.80	0.031

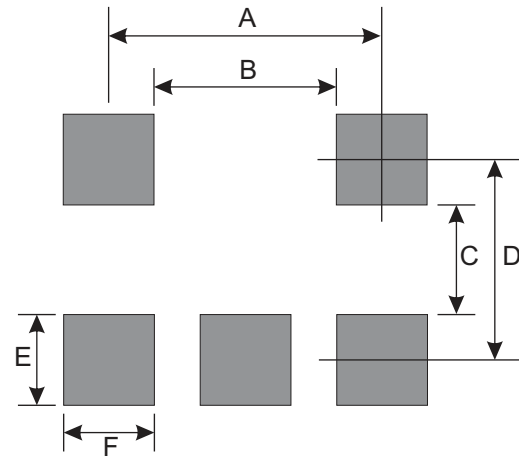

Standard Packaging

Case Type	Qty Per Reel	Reel Size
	(Pcs)	(inch)
SOT-23F-5P	3,000	7