

DS14C239 Dual Supply TIA/EIA-232 3 x 5 Driver/Receiver

General Description

The DS14C239 is a three driver, five receiver device which conforms to the TIA/EIA-232-E standard and CCITT V.28 recommendations. This device eliminates $-12V$ supply by employing an internal DC-DC converter to generate the necessary output levels from a single $+5V$ supply and a positive voltage power supply ($+7.5V$ to $+13.2V$). Driver slew rate control and receiver noise filtering have also been internalized to eliminate the need for external slew rate control and noise filtering capacitors. With the addition of TRI-STATE® receiver outputs, device power consumption is kept to a minimum.

The combination of its low power requirement and extended operating temperature range makes this device an ideal choice for a wide variety of commercial, industrial, and battery powered applications.

Features

- Conforms to TIA/EIA-232-E and CCITT V.28
- Internal DC-DC converter
- Low power requirement: $I^+ = 10 \text{ mA max}$
 $I_{CC} = 1 \text{ mA max}$
- Internal driver slew rate control
- Receiver Noise Filtering
- Operates above 120 kbits/sec
- TRI-STATE Receiver Outputs
- Direct replacement for MAX239
- Industrial temperature range option—DS14C239T
(-40°C to $+85^\circ\text{C}$)

Connection Diagram

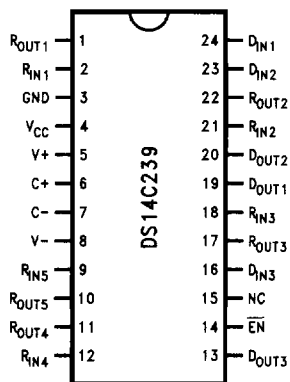

TL/F/11283-1

Order Number DS14C239N, DS14C239WM,
DS14C239TN or DS14C239TWM
See NS Package Number M24B or NA24G

Functional Diagram

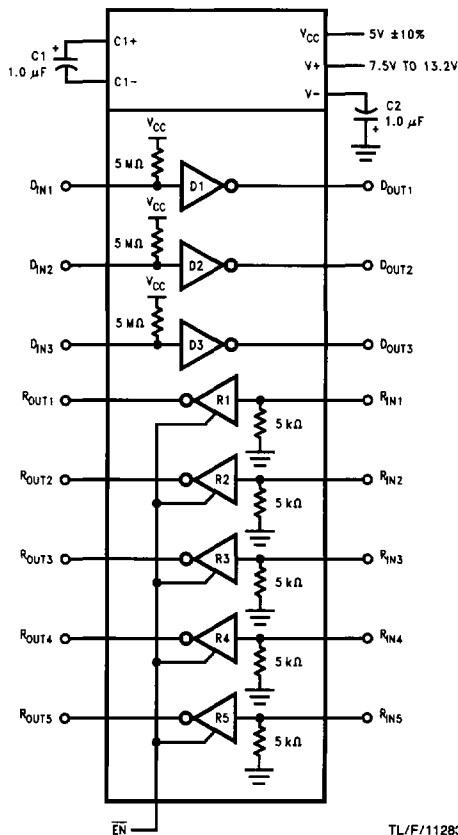

TL/F/11283-2

Absolute Maximum Ratings (Note 1)

If Military/Aerospace specified devices are required, please contact the National Semiconductor Sales Office/Distributors for availability and specifications.

Supply Voltage (V _{CC})	-0.3V to +6V
V+ Pin	(V _{CC} - 0.3V) to +15V
V- Pin	+0.3V to -15V
Driver Input Voltage	-0.3V to (V _{CC} + 0.3V)
Driver Output Voltage	(V+ + 0.3V) to (V- - 0.3V)
Receiver Input Voltage	±30V
Receiver Output Voltage	-0.3V to (V _{CC} + 0.3V)
Junction Temperature	+150°C
Maximum Package Power Dissipation @ +25°C (Note 6)	
N Package	2400 mW
WM Package	1400 mW

Storage Temperature Range	-65°C to +150°C
Lead Temperature (Soldering, 4 sec.)	+260°C
Short Circuit Duration (D _{OUT})	continuous
ESD Rating (HBM, 1.5 kΩ, 100 pF)	≥ 2.0 kV

Recommended Operating Conditions

	Min	Max	Units
Supply Voltage (V _{CC})	4.5	5.5	V
Supply Pin (V+)	7.5	13.2	V
Operating Free Air Temp. (T _A)			
DS14C239	0	+70	°C
DS14C239T	-40	+85	°C

Electrical Characteristics

Over recommended operating conditions, unless otherwise specified (Note 2)

Symbol	Parameter	Conditions	Min	Typ	Max	Units
DEVICE CHARACTERISTICS						
V-	Negative Power Supply	R _L = 3 kΩ, C1, C2 = 1.0 μF, D _{IN} = 2.0V		-9.5		V
I+	Supply Current (V+)	No Load		4	10	mA
I _{CC}	Supply Current (V _{CC})	No Load		0.1	1.0	mA
DRIVER CHARACTERISTICS						
V _{IH}	High Level Input Voltage		2.0		V _{CC}	V
V _{IL}	Low Level Input Voltage		GND		0.8	V
I _{IH}	High Level Input Current	V _{IN} ≥ 2.0V	-10		+10	μA
I _{IL}	Low Level Input Current	V _{IN} ≤ 0.8V	-10		+10	μA
V _{OH}	High Level Output Voltage	R _L = 3 kΩ	5.0	8.7		V
V _{OL}	Low Level Output Voltage			-8.0	-5.0	V
I _{OS} ⁺	Output High Short Circuit Current	V _O = 0V, V _{IN} = 0.8V	-40	-20	-5.0	mA
I _{OS} ⁻	Output Low Short Circuit Current	V _O = 0V, V _{IN} = 2.0V	5.0	16	40	mA
R _O	Output Resistance	-2V ≤ V _O ≤ +2V, V _{CC} = V+ = GND = 0V	300			Ω
RECEIVER CHARACTERISTICS						
V _{TH}	Input High Threshold Voltage	T _A = 25°C		2	2.4	V
		T _A = -40°C to +85°C		2	2.6	V
V _{TL}	Input Low Threshold Voltage		0.8	1.5		V
V _{HY}	Hysteresis	T _A = 25°C	0.2	0.5	1.0	V
		T _A = -40°C to +85°C	0.1	0.5	1.0	V

Electrical Characteristics (Continued)

Over recommended operating conditions, unless otherwise specified (Note 2)

Symbol	Parameter	Conditions	Min	Typ	Max	Units	
RECEIVER CHARACTERISTICS (Continued)							
R_{IN}	Input Resistance		3.0	4.5	7.0	k Ω	
I_{IN}	Input Current	$V_{IN} = +15V$	2.14	3.8	5.0	mA	
		$V_{IN} = +3V$	0.43	0.6	1.0	mA	
		$V_{IN} = -3V$	-1.0	-0.6	-0.43	mA	
		$V_{IN} = -15V$	-5.0	-3.8	-2.14	mA	
V_{OH}	High Level Output Voltage	$V_{IN} = -3V, I_O = -3.2\text{ mA}$	3.5	4.5		V	
		$V_{IN} = -3V, I_O = -20\ \mu\text{A}$	4.0	4.9		V	
V_{OL}	Low Level Output Voltage	$V_{IN} = +3V, I_O = +3.2\text{ mA}$		0.25	0.4	V	
V_{IH}	High Level Input Voltage	\overline{EN}	2.4		V_{CC}	V	
V_{IL}	Low Level Input Voltage		GND		0.8	V	
I_{IH}	High Level Input Current		$V_{IN} \geq 2.4V$	-10		+10	μA
I_{IL}	Low Level Input Current		$V_{IN} \leq 0.8V$	-10		+10	μA
I_{OZ}	Output Leakage Current	$\overline{EN} = V_{CC}, 0V \leq R_{OUT} \leq V_{CC}$	-10	0.1	+10	μA	

Switching Characteristics

Over recommended operating conditions, unless otherwise specified (Note 4)

Symbol	Parameter	Conditions	Min	Typ	Max	Units
DRIVER CHARACTERISTICS						
t_{PLH}	Propagation Delay LOW to HIGH	$R_L = 3\text{ k}\Omega$ $C_L = 50\text{ pF}$ (Figures 1 and 2)		0.7	4.0	μs
t_{PHL}	Propagation Delay HIGH to LOW			0.7	4.0	μs
t_{sk}	Skew $ t_{PLH} - t_{PHL} $			0	1.0	μs
SR1	Output Slew Rate	$R_L = 3\text{ k}\Omega$ to $7\text{ k}\Omega$, $C_L = 50\text{ pF}$, $V^+ \leq 10.35V$	4.0	17	30	V/ μs
SR2	Output Slew Rate	$R_L = 3\text{ k}\Omega$, $C_L = 2500\text{ pF}$, $V^+ \leq 10.35V$	3.0	6.4		V/ μs

RECEIVER CHARACTERISTICS

t_{PLH}	Propagation Delay LOW to HIGH	Input Pulse Width $> 10\ \mu\text{s}$ $C_L = 50\text{ pF}$ (Figures 3 and 4)		2.1	6.5	μs
t_{PHL}	Propagation Delay HIGH to LOW			2.9	6.5	μs
t_{sk}	Skew $ t_{PLH} - t_{PHL} $			0.8	2.0	μs
t_{PLZ}		(Figures 5 and 7)		0.25	2.0	μs
t_{PZL}				0.70	2.0	μs
t_{PHZ}		(Figures 5 and 6)		0.25	2.0	μs
t_{PZH}				0.70	2.0	μs
t_{nw}	Noise Pulse Width Rejected	(Figures 3 and 4)		2.0	1.0	μs

Note 1: "Absolute Maximum Ratings" are those values beyond which the safety of the device cannot be guaranteed. They are not meant to imply that the devices should be operated at these limits. The tables of "Electrical Characteristics" specify conditions for device operation.

Note 2: Current into device pins is defined as positive. Current out of device pins is defined as negative. All voltages are referenced to ground unless otherwise specified.

Note 3: I_{OS}^+ and I_{OS}^- values are for one output at a time. If more than one output is shorted simultaneously, the device power dissipation may be exceeded.

Note 4: Receiver AC input waveform for test purposes: $t_r = t_f = 200\text{ ns}$, $V_{IH} = 3V$, $V_{IL} = -3V$, $f = 64\text{ kHz}$ (128 kbits/sec). Driver AC input waveform for test purposes: $t_r = t_f = 10\text{ ns}$, $V_{IH} = 3V$, $V_{IL} = 0V$, $f = 64\text{ kHz}$ (128 kbits/sec).

Note 5: All typicals are given for $V_{CC} = 5.0V$ and $T_A = +25^\circ\text{C}$, $V^+ = 10.35V$.

Note 6: Ratings apply to ambient temperature at $+25^\circ\text{C}$. Above this temperature derate: N package 20 mW/ $^\circ\text{C}$ and WM package 13.5 mW/ $^\circ\text{C}$.

Parameter Measurement Information

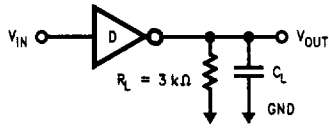

FIGURE 1. Driver Load Circuit

TL/F/11283-4

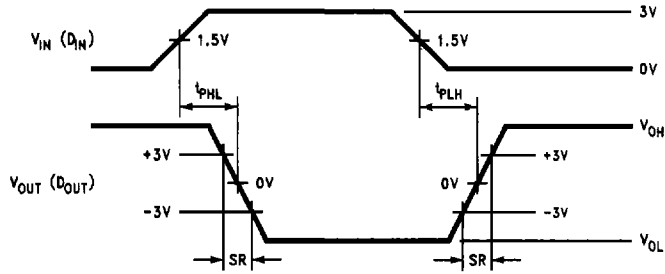

FIGURE 2. Driver Switching Waveform

TL/F/11283-5

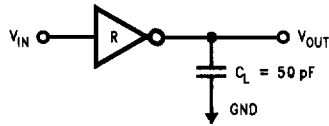

FIGURE 3. Receiver Load Circuit

TL/F/11283-6

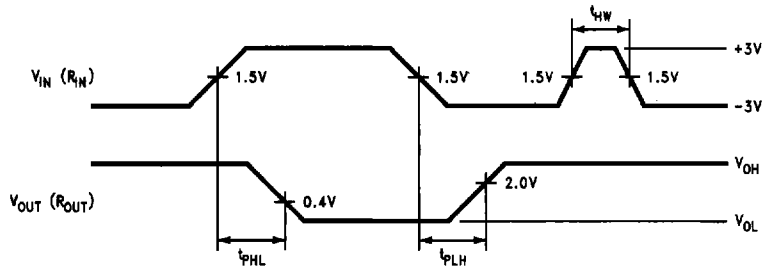

FIGURE 4. Receiver Propagation Delays and Noise Rejection

TL/F/11283-7

Parameter Measurement Information (Continued)

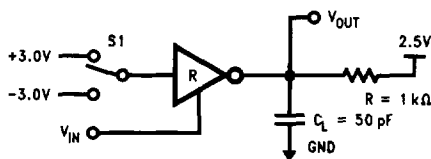

FIGURE 5. Receiver Disable Load Circuit

TL/F/11283-8

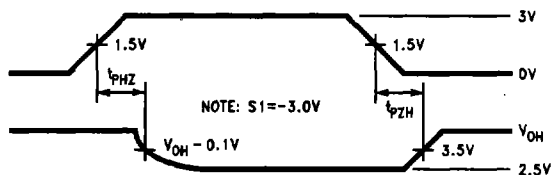

FIGURE 6. Receiver TRI-STATE Timing (t_{PHZ} , t_{PZH})

TL/F/11283-9

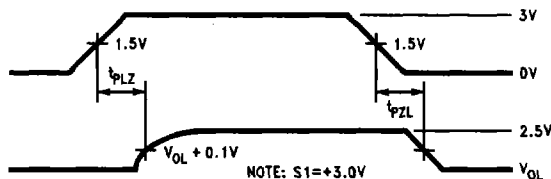

FIGURE 7. Receiver TRI-STATE Timing (t_{PLZ} , t_{PZL})

TL/F/11283-10

Pin Descriptions

V_{CC} (pin 4)—Power supply pin for the device, +5V ($\pm 10\%$).

V⁺ (pin 5)—Positive supply for TIA/EIA-232-E drivers. Specified at 7.5V minimum and 13.2V maximum.

V⁻ (pin 8)—Negative supply for TIA/EIA-232-E drivers. Recommended external capacitor: $C_2 = 1.0 \mu\text{F}$ (16V). This supply is not intended to be loaded externally.

C1⁺, C1⁻ (pins 6, 7)—External capacitor connection pins. Recommended capacitor— $1.0 \mu\text{F}$ (16V).

EN (pin 14)—Controls the Receiver output TRI-STATE Circuit. A High level on this pin will disable the Receiver Output.

D_{IN} 1-3 (pins 24, 23, 16)—Driver input pins are TTL/CMOS compatible. Inputs of unused drivers may be left open, an internal pull-up resistor (500 k Ω minimum, typically 5 M Ω) pulls input to V_{CC}. Output will be LOW for open inputs.

D_{OUT} 1-3 (pins 19, 20, 13)—Driver output pins conform to TIA/EIA-232-E levels.

R_{IN} 1-5 (pins 2, 21, 18, 12, 9)—Receiver input pins accept TIA/EIA-232-E input voltages ($\pm 15\text{V}$). Receivers feature a noise filter and guaranteed hysteresis of 100 mV. Unused receiver input pins may be left open. Internal input resistor (5 k Ω) pulls input LOW, providing a failsafe HIGH output.

R_{OUT} 1-5 (pins 1, 22, 17, 11, 10)—Receiver output pins are TTL/CMOS compatible. Receiver output HIGH voltage is specified for both CMOS and TTL load conditions.

GND (pin 3)—Ground pin.