

# 430BOOST-SENSE1 - Capacitive Touch BoosterPack for the LaunchPad

## User's Guide



Literature Number: SLAU337B  
April 2011–Revised May 2013

---



---



---

|  |           |
|--|-----------|
| <b>Preface</b> .....   | <b>4</b>  |
| <b>1 430BOOST-SENSE1 Overview</b> .....  | <b>5</b>  |
| 1.1 Overview .....   | 5         |
| 1.2 Kit Contents .....   | 6         |
| <b>2 Getting Started With 430BOOST-SENSE1 BoosterPack</b> .....                | <b>7</b>  |
| 2.1 Hardware Preparation .....   | 7         |
| 2.2 Software Preparation .....   | 7         |
| 2.3 Capacitive Touch User Experience .....                                     | 8         |
| <b>3 Capacitive Touch BoosterPack Hardware</b> .....                           | <b>12</b> |
| 3.1 Driving the LEDs .....   | 13        |
| 3.2 Capacitive Touch Sensors .....   | 14        |
| <b>4 LaunchPad Capacitive Touch BoosterPack User Experience Firmware</b> ..... | <b>15</b> |
| 4.1 Import Project in CCS .....  | 15        |
| 4.2 Open Project and Workspace in IAR Embedded Workbench .....                 | 15        |
| 4.3 Capacitive Touch Software Library .....                                    | 16        |
| <b>5 LaunchPad Capacitive Touch BoosterPack User Experience Software</b> ..... | <b>18</b> |
| 5.1 LaunchPad Capacitive Touch BoosterPack User Experience GUI .....           | 18        |
| 5.2 MediaPad .....   | 18        |
| 5.3 UART Communication Protocol .....  | 19        |
| <b>6 Frequently Asked Questions (FAQ), Tips, and Tricks</b> .....              | <b>20</b> |
| <b>7 References</b> .....  | <b>20</b> |
| <b>8 Schematics and PCB Layout</b> .....                                       | <b>21</b> |
| 8.1 Schematics .....   | 21        |
| 8.2 PCB Layout .....   | 22        |
| 8.3 Bill of Materials (BOM) .....  | 22        |
| <b>Revision History</b> .....  | <b>23</b> |

## List of Figures

|    |  |    |
|----|--|----|
| 1  | Capacitive Touch BoosterPack With LaunchPad .....                      | 5  |
| 2  | PC GUI Looking for LaunchPad .....                                     | 9  |
| 3  | PC GUI in Sleep Mode .....   | 9  |
| 4  | PC GUI in Active Mode .....  | 10 |
| 5  | MediaPad .....   | 11 |
| 6  | Capacitive Touch BoosterPack Hardware .....                            | 12 |
| 7  | Schematic LED Multiplexing .....                                       | 13 |
| 8  | Driving LEDs .....   | 13 |
| 9  | Capacitive Touch Sensor Areas .....                                    | 14 |
| 10 | Capacitive Touch BoosterPack Schematic.....                            | 21 |
| 11 | Capacitive Touch BoosterPack Layout, Top Layer .....                   | 22 |
| 12 | Capacitive Touch BoosterPack Layout, Bottom Layer and Silkscreen ..... | 22 |

## List of Tables

|   |                             |    |
|---|-----------------------------|----|
| 1 | BoosterPack Interface ..... | 12 |
| 2 | Bill of Materials.....      | 22 |

## Read This First

---

---

---

### If You Need Assistance

If you have any feedback or questions, support for MSP430 devices, the MSP-EXP430G2 LaunchPad, and the 430BOOST-SENSE1 Capacitive Touch BoosterPack for the LaunchPad is provided by the Texas Instruments Product Information Center (PIC) and the TI E2E Forum (<https://community.ti.com/forums/12.aspx>). Contact information for the PIC can be found on the TI web site at [support.ti.com](http://support.ti.com). Additional device-specific information can be found on the MSP430 web site at [www.ti.com/msp430](http://www.ti.com/msp430).

### Related Documentation from Texas Instruments

The primary sources of MSP430 information are the device-specific data sheets and user's guides. The most up-to-date versions of the user's guide documents available at [www.ti.com/msp430](http://www.ti.com/msp430). Information specific to the MSP-EXP430G2 LaunchPad Experimenter Board and the different BoosterPacks can be found at [focus.ti.com/docs/toolsw/folders/print/msp-exp430g2.html](http://focus.ti.com/docs/toolsw/folders/print/msp-exp430g2.html) or the LaunchPad wiki page at [processors.wiki.ti.com/index.php/MSP430\\_LaunchPad\\_\(MSP-EXP430G2\)](http://processors.wiki.ti.com/index.php/MSP430_LaunchPad_(MSP-EXP430G2)).

User's guides and detailed information on setting up a project for the MSP430 using Code Composer Studio or IAR Embedded Workbench can be found at the *Tools & Software* section of the MSP430 landing page [www.ti.com/msp430](http://www.ti.com/msp430).

### FCC Warning

This equipment is intended for use in a laboratory test environment only. It generates, uses, and can radiate radio frequency energy and has not been tested for compliance with the limits of computing devices pursuant to subpart J of part 15 of FCC rules, which are designed to provide reasonable protection against radio frequency interference. Operation of this equipment in other environments may cause interference with radio communications, in which case, the user will be required to take whatever measures may be required to correct this interference his own expense.

# **430BOOST-SENSE1 - Capacitive Touch BoosterPack for the LaunchPad**

---

---

---

## **1 430BOOST-SENSE1 Overview**

### **1.1 Overview**

The 430BOOST-SENSE1 Capacitive Touch BoosterPack is the first extension module for the MSP-EXP430G2 MSP430 LaunchPad Value Line Development Kit (see [Figure 1](#)). Extension modules such as this one, designed specifically for the LaunchPad, are called BoosterPacks, and each features an application example for one of the MSP430 Value Line devices. The BoosterPacks can be connected to the MSP-EXP430G2 with both 10-pin male headers (included in MSP-EXP430G2 kit) soldered onto the board and, therefore, use all available pins on the MSP430G2452 Value Line device.



**Figure 1. Capacitive Touch BoosterPack With LaunchPad**

The Capacitive Touch BoosterPack is available for purchase from the TI eStore:  
<https://estore.ti.com/430BOOST-SENSE1-Capacitive-Touch-BoosterPack-P2361C42.aspx>.

The Capacitive Touch BoosterPack features the new MSP430G2xx2 devices, which are capable of driving up to 16 capacitive-touch enabled I/O pins. The included MSP430G2452 device allows for low-cost capacitive-sensing and approximation-sensing applications without the use of any external components. The BoosterPack includes a capacitive-touch board and an MSP430G2452 device that is preprogrammed with a demo application. The user experience application demonstrates capacitive touch as standalone feature by showing the user interaction directly with the onboard LEDs, by a GUI, or by an application example on a Microsoft Windows PC.

430BOOST-SENSE1 features:

- Nine LEDs giving instant feedback to user interaction
- Six capacitive-touch areas (a button, a 4-element wheel, and a proximity sensor)
- One preprogrammed MSP430G2452 device

For latest information on the LaunchPad, other available BoosterPacks, software examples, and how to program the included MSP430G2452 device, see the *MSP-EXP430G2 LaunchPad Experimenter Board User's Guide* ([SLAU318](#)) or the LaunchPad wiki page [processors.wiki.ti.com/index.php/MSP430\\_LaunchPad\\_\(MSP-EXP430G2\)](http://processors.wiki.ti.com/index.php/MSP430_LaunchPad_(MSP-EXP430G2)).

## 1.2 Kit Contents

The 430BOOST-SENSE1 kit includes two components:

- One Capacitive Touch BoosterPack board with nine LEDs and six sensor areas
- One preprogrammed MSP430G2452 device

This device is a low-power 16-bit microcontroller with an 8-channel 10-bit ADC, comparator, universal serial interface that supports SPI and I2C, 8kB flash memory, and 256B RAM memory

## 2 Getting Started With 430BOOST-SENSE1 BoosterPack

The following sections describe the preparation necessary to run the user experience application demo and to start developing applications with the MSP430G2452 for the Capacitive Touch BoosterPack.

### 2.1 Hardware Preparation

To prepare the Capacitive Touch BoosterPack hardware for its first use:

1. Solder both 10-pin male headers onto the LaunchPad's breakout pin connections J1 and J2. These two 10-pin male headers and two 10-pin female headers come with the original LaunchPad kit.

---

**NOTE:** If the 10-pin female headers are populated, use the 10-pin male headers as adapter to further extend the connections to the LaunchPad. The additional distance adds minimal base capacitance and does not affect the user experience of the kit.

---

2. Remove the J5 connections on the LaunchPad to disconnect the LaunchPad LEDs and keep them from interfering with P1.0 and P1.6 functions of the Capacitive Touch BoosterPack.
3. Ensure jumpers VCC, TXD, and RXD of the J3 connection are populated for the user experience demo to operate properly.

---

**NOTE:** The jumpers RST and TEST must also be populated when programming the device. They are not required for normal application operation.

---

4. Replace the existing MSP430 device in the LaunchPad MCU socket with the MSP430G2452 device that comes with the Capacitive Touch BoosterPack kit.

---

**NOTE:** Some revision 1.4 LaunchPad kits need a firmware update to support the MSP430G2452 devices; see FAQ #1 in [Section 6](#).

---

5. Connect the Capacitive Touch BoosterPack board to the LaunchPad with proper orientation by ensuring that the Texas Instruments logo and the text on the BoosterPack are in the same direction as the text and logo on the Launchpad.
6. Connect the LaunchPad with an USB cable to a PC or connect an external power supply (2.7 V to 3.6 V) to J6. The user experience demo application lights the center LED when power is supplied to the board.

---

**NOTE:** The 32-kHz crystal/oscillator on pins 18 and 19 is not required for the user experience application to run.

---

### 2.2 Software Preparation

The steps described in the following sections are not required for a LaunchPad Capacitive Touch BoosterPack stand-alone demo. For all other purposes that require PC software interaction, proper installation of the hardware driver and the software is required. To develop applications, its also necessary to install one of the IDEs shown on the Tools and Software section of the MSP430 landing page [www.ti.com/msp430](http://www.ti.com/msp430). More information on how to start developing applications for the LaunchPad and how to install the drivers and IDEs that it requires can be found on the LaunchPad wiki page [http://processors.wiki.ti.com/index.php/MSP430\\_LaunchPad\\_\(MSP-EXP430G2\)](http://processors.wiki.ti.com/index.php/MSP430_LaunchPad_(MSP-EXP430G2)).

All LaunchPad Capacitive Touch BoosterPack User Experience firmware and software described in the following sections are provided in both binary/executable and source code forms, along with drivers and supporting documentation. [10] A zip file containing these items can be downloaded from [www.ti.com/lit/zip/slac490](http://www.ti.com/lit/zip/slac490).

The same software package link and updates can also be found on the LaunchPad wiki page [http://processors.wiki.ti.com/index.php/MSP430\\_LaunchPad\\_\(MSP-EXP430G2\)](http://processors.wiki.ti.com/index.php/MSP430_LaunchPad_(MSP-EXP430G2)). When this package is installed, all user experience application demos are stored in the *Software* folder in the selected installation directory, and the source code for the projects can be found in the *Source* folder.

### 2.2.1 LaunchPad USB Driver

For the PC to communicate with the LaunchPad hardware, the LaunchPad USB driver must be installed. If this is the first time the LaunchPad is connected to the PC, install the USB serial COM port driver located at [INSTALL\_PATH]\LaunchPad\_Driver\LaunchPad\_Driver.exe.

---

**NOTE:** The LaunchPad USB drivers are integrated into the IDE installer packages from Code Composer Studio (version 4+) or IAR Embedded Workbench (version 5.20+) and do not require a second installation if an IDE has already been installed.

---

### 2.2.2 Locate Software Programs

Two software programs are provided to work with the LaunchPad Capacitive Touch BoosterPack user experience demo. They are both installed to the [INSTALL\_PATH]\Software folder. All software and firmware examples are also available as source code in the capacitive touch software package.

## 2.3 Capacitive Touch User Experience

The Capacitive Touch User Experience consists of three projects:

- The firmware application that can operate in stand-alone mode (LaunchPad Capacitive Touch BoosterPack Firmware Demo)
- A processing GUI that displays the information from the LaunchPad Capacitive Touch BoosterPack visually (LaunchPad Capacitive Touch BoosterPack GUI Demo)
- A Visual Studio program that uses the LaunchPad Capacitive Touch BoosterPack input to control media in Windows (MediaPad).

### 2.3.1 LaunchPad Capacitive Touch BoosterPack Firmware Demo

The application described in this section can be used as either a stand-alone demo (no PC required) or as a demo with PC applications running. If PC application is desired, make sure to start the PC application execution before proceeding with step 2.

1. Plug the LaunchPad with Capacitive Touch BoosterPack into a USB source (such as USB port on PC, USB hub, or USB battery pack) via the mini-USB connector or to a battery pack via the power pin connector J6. The User Experience application starts up and remains in sleep mode, with only the center LED on.
2. Slowly wave your hand or finger approximately 3 to 5 cm above the BoosterPack to trigger the proximity sensor and to wake the device. During the wake-up period, the LEDs surrounding the wheel light in a wake-up sequence, starting with a slow clockwise rotation and ending with a fast counter-clockwise rotation. As this sequence ends, the device enters active mode.
3. To perform a touch, firmly press any position on the wheel or the center button. Make sure to keep your finger between the circles of the wheel.
  - Upon releasing a touch on the center button, the center LED toggles.
  - Touching a wheel position lights up the corresponding LEDs.
4. To perform a gesture, slide your finger along the wheel without releasing it from the wheel. The corresponding LEDs trace and follow the touch and gesture.
5. After a short time of no capacitive touch activity, the board returns to sleep mode. Only the center LED stays on.
6. Go back to step 2 to re-enable the application active mode.



### 2.3.2 LaunchPad Capacitive Touch BoosterPack GUI Demo

This section describes how to run the application on both the LaunchPad Capacitive Touch BoosterPack and the PC. It assumes that the hardware is connected to the PC via USB cable (see step 1 of [Section 2.3.1](#)) and that the software has been installed (see [Section 2.2](#)).

The following steps correspond to the instructions in [Section 2.3.1](#).

1. Start the CapTouch\_BoosterPack\_UserExperience\_GUI.exe application located at [INSTALL\_PATH]\Software\CapTouch\_BoosterPack\_UserExperience\_GUI\.

When the GUI starts, it checks for a valid LaunchPad USB serial COM port. If no compatible port connection is available, the GUI prompts user to plug in the LaunchPad Capacitive Touch BoosterPack (see [Figure 2](#)). The GUI continues normally if it detects that a LaunchPad is plugged into the PC.



**Figure 2. PC GUI Looking for LaunchPad**

2. At start-up or after long period of inactivity, the device enters sleep mode and the GUI is disabled (grayed out) to indicate sleep mode (see [Figure 3](#)). Upon proximity sensor detection (for example, wave your hand approximately 3 to 5 cm above the BoosterPack) the device returns to active mode and enables the GUI.



**Figure 3. PC GUI in Sleep Mode**

3. The 'Center Button' press data toggles the center circle color, mimicking the behavior of the center LED on the BoosterPack.

The 'Wheel Tap' is represented by lighting up a single slice on the wheel and displaying the field number on the top left corner of the PC GUI.

4. The gesture tracking (Start, Stop, and Update) is visualized on the wheel with the coloring of the wheel slices (see Figure 4). Gesture can be tracked for several revolutions of the wheel, in both clockwise and counter-clockwise directions <sup>(1)</sup>.



**Figure 4. PC GUI in Active Mode**

5. After a short time when no capacitive touch activity is detected, the board returns to sleep mode and the GUI is disabled.

### 2.3.3 MediaPad

This section describes instructions to run the MediaPad application on the LaunchPad Capacitive Touch BoosterPack and the PC. It assumes that the hardware is connected to the PC via USB cable (see step 1 of Section 2.3.1) and that the software has been installed (see Section 2.2).

1. Start the MediaPad.exe application located at [INSTALL\_PATH]\Software\MediaPad\
2. At startup, the application searches for a LaunchPad or an eZ430 emulator compatible USB serial COM port.
  - If no compatible COM port is found, the application displays an error message and then exits.
  - If a LaunchPad COM port is found, the application displays a greeting message. When the user closes the message, the application minimizes itself to the taskbar.
3. When the LaunchPad Capacitive Touch BoosterPack is in sleep mode, no data is transferred and no activity occurs in the program. Use hand/finger wave motion to trigger the proximity sensor and wake up the device.
4. The following touches or gestures can be used for media control in a Windows system (see Figure 5).
  - (a) Center button press: Start media player (Windows Media Player by default)
  - (b) Bottom arrow button press: Play/Pause
  - (c) Left arrow button press: Previous Track
  - (d) Right arrow button press: Next Track
  - (e) Scroll wheel clockwise: Volume Up
  - (f) Scroll wheel counter-clockwise: Volume Down

<sup>(1)</sup> Using the wheel, a hidden mode can be unlocked. Input the correct sequence (similar to a rotational combination lock) to reveal a secret.

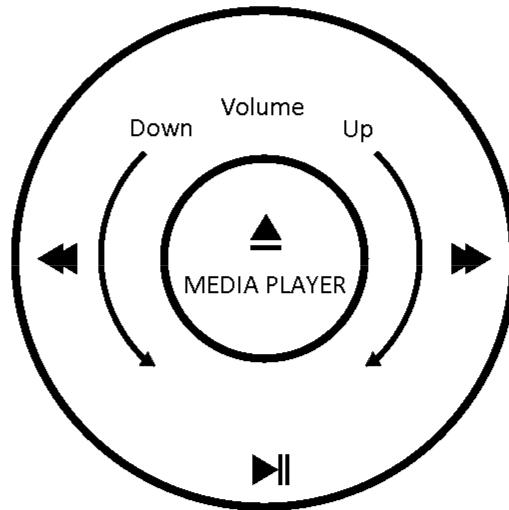

**Figure 5. MediaPad**

---

**NOTE:** The Microsoft .NET runtime library is required to run the MediaPad software. While most recent Windows PCs have the .Net runtime library installed, a new or reinstall of the library might be necessary.

---

### 3 Capacitive Touch BoosterPack Hardware

As shown in [Figure 6](#) and [Table 1](#), the Capacitive Touch BoosterPack is a typical capacitive touch application example for the new MSP430G2xx2 capacitive-touch enabled I/O pins. The board shows three different capacitive sensor types: a single button in the middle, a wheel made of four single capacitive sensors, and a proximity sensor around the edge of the PCB. In addition, there are nine LEDs on the board to give instant feedback to user interaction. The eight LEDs around the wheel are multiplexed to increase their number without using too many of the microcontrollers I/O pins. By using a time-shared signal, only five I/O pins are used to drive all eight LEDs.



**Figure 6. Capacitive Touch BoosterPack Hardware**

**Table 1. BoosterPack Interface**

| Pin | MSP430 Port | BoosterPack Signal | Description   |
|-----|-------------|--------------------|---|
| 1   | VCC         | NC                 | Supply voltage, not connected to BoosterPack                        |
| 2   | P1.0        | LED9               | The white center LED  |
| 3   | P1.1/TXD    | NC                 | Backchannel UART transmit data output, not connected to BoosterPack |
| 4   | P1.2/RXD    | NC                 | Backchannel UART receive data input, not connected to BoosterPack   |
| 5   | P1.3        | LEDx               | LED base to drive the eight multiplexed LEDs                        |
| 6   | P1.4        | LED1               | LED1 positive and LED5 negative drive                               |
| 7   | P1.5        | LED2               | LED2 positive and LED6 negative drive                               |
| 8   | P2.0        | SENS0              | Capacitive-touch proximity sensor                                   |
| 9   | P2.1        | SENS1              | Capacitive-touch wheel sensor left                                  |
| 10  | P2.2        | SENS2              | Capacitive-touch wheel sensor down                                  |
| 11  | P2.3        | SENS3              | Capacitive-touch wheel sensor right                                 |
| 12  | P2.4        | SENS4              | Capacitive-touch wheel sensor up                                    |
| 13  | P2.5        | SENS5              | Capacitive-touch center button sensor                               |
| 14  | P1.6        | LED3               | LED3 positive and LED7 negative drive                               |
| 15  | P1.7        | LED4               | LED4 positive and LED8 negative drive                               |
| 16  | RST/SBWTIO  | NC                 | Reset line for SBW JTAG data, not connected to BoosterPack          |
| 17  | TEST/SBWTC  | NC                 | Test line for SBW JTAG clock, not connected to BoosterPack          |
| 18  | P2.6/XOUT   | NC                 | Oscillator output, not connected to BoosterPack                     |
| 19  | P2.7/XIN    | NC                 | Oscillator input, not connected to BoosterPack                      |
| 20  | GND         | GND                | Supply ground   |

### 3.1 Driving the LEDs

The white center LED is connected to port P1.0 of the Value Line device and can be turned on by setting this port as output. The other eight LEDs are multiplexed as shown in Figure 7. Four LEDs are connected with the diode cathodes to the ports P1.4 to P1.7, and the other four LEDs are connected with the diode anodes. All LEDs are connected to port P1.3 to either source or drain four LEDs at any one time. To drive a particular set of these eight LEDs, two steps are required:

1. Port P1.3 acts as GND drain, so that the first nibble can drive LED1 to LED4 directly. The other LEDs are not active during this time.
2. Port P1.3 acts as a VCC source to light LED5 to LED8. The pattern for the second nibble must be inverted and set to port P1.4 to P1.7.

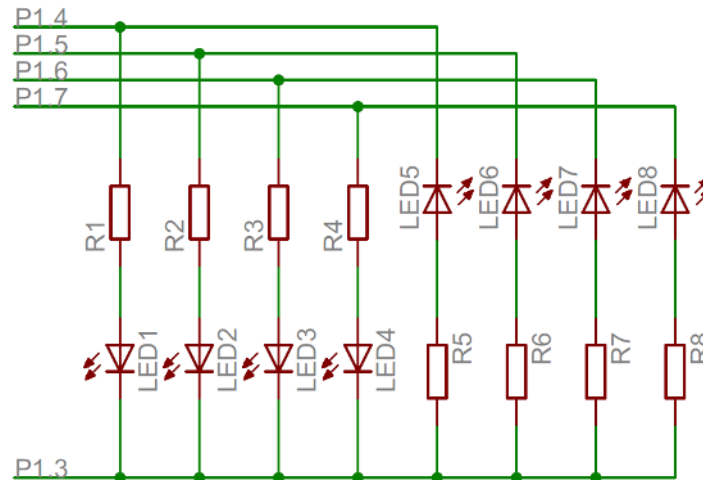

Figure 7. Schematic LED Multiplexing

Switching between modes can be controlled by a timer and has to be at least 100 times a second to generate the illusion of a constant light pattern. To reduce glitches while switching the LED modes, it is recommended to set the LED signals that are not being driven to input mode. Figure 8 shows the signals of all the LED driving pins required to light up LED1, LED3, LED6, and LED7. The mode on P1.3 can be set before or after the LED settings, as long as the unused LEDs are set to input mode.

**NOTE:** The current user experience implementation is not using a time-shared approach to drive the LEDs, due to the shared CPU and timer resources utilized by the Capacitive Touch Software Library [7] functions and the UART transmissions.

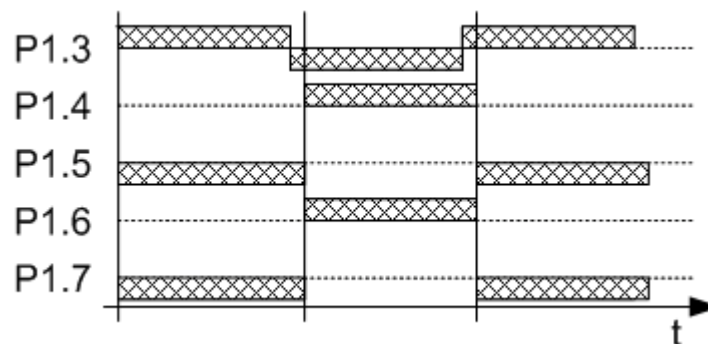
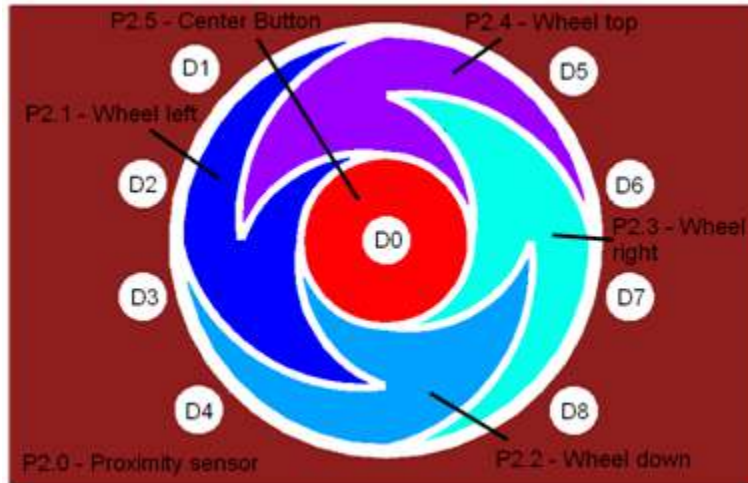

Figure 8. Driving LEDs

### 3.2 Capacitive Touch Sensors

The six different capacitive touch sensor areas are connected to the Port 2 of the device. On the MSP430 Value Line devices with capacitive-touch enabled I/Os, Port 2 I/Os have no analog functionality. These I/Os also have a smaller internal capacitance than Port 1, which make these them more sensitive than the capacitive touch sensors on Port 1.

Figure 9 shows the connection of the capacitive touch sensor areas to the MSP430.



**Figure 9. Capacitive Touch Sensor Areas**

To enable the capacitive-touch feature of the I/Os, set the secondary port select PxSEL2 and clear the PxSEL bit. The selected pins start oscillating immediately, and the frequency is a direct indication of the capacitance connected to the port pin. The capacitive-touch I/Os oscillate within a frequency range of 1 to 2 MHz, which is strongly dependant on the supply voltage, the device package, and environmental influences. For more information about the capacitive-touch feature of the Value Line devices, to download code example, or to find application examples, go to the Capacitive Touch BoosterPack wiki page ([http://processors.wiki.ti.com/index.php/MSP430\\_LaunchPad\\_\(MSP-EXP430G2\)](http://processors.wiki.ti.com/index.php/MSP430_LaunchPad_(MSP-EXP430G2))) or get the MSP430 Capacitive Touch Software Library (<http://focus.ti.com/docs/toolsw/folders/print/capsenselibrary.html>), which is used in the application demo included in this kit.

---

**NOTE:** The Capacitive Touch BoosterPack hardware can also be used with other MSP430 devices. Resistors R10 to R15 must be populated with a resistor to realize a RC discharge that can be measured with a timer.

---

## 4 LaunchPad Capacitive Touch BoosterPack User Experience Firmware

This section describes the firmware application that is provided with the project. Detailed information on the project construction, use of the Capacitive Touch Software Library, and how to set up and import the projects is included. Source code for the MSP430G2452 firmware application is installed to the [INSTALL\_PATH]\Source\ folder as described in [Section 2.2](#).

The User Experience application operates on the LaunchPad platform using the MSP430G2452 device and the Capacitive Touch BoosterPack plugin board. The capacitive touch and proximity sensing are enabled by the pin oscillator feature, which is new to the MSP430G2xx2 family devices. The User Experience application also uses the Capacitive Touch Software Library [7] to realize and measure the capacitive touch and proximity sensors. The Capacitive Touch Software Library provides layers of abstraction to generate higher logical outputs such as logical touches and their position (in this hardware, a four-button wheel).

The User Experience application starts in sleep mode, sampling the proximity sensor approximately every 8.3 ms ( $VLO / 100 = 12 \text{ kHz} / 100 = 120 \text{ Hz}$ ). Upon registering a valid proximity event (for example, a hand, finger, or object hovering approximately 3 to 5 cm from the BoosterPack), the application enters the active mode. During the wake-up period, the LEDs surrounding the wheel light in a wake-up sequence, starting with a slow clockwise sequence and ending with a fast counter-clockwise sequence. As this sequence ends, the device enters active mode.

In active mode, the application samples and registers individual finger touches on the 16-position wheel or the center button. It also recognizes simple gestures (clockwise and counter-clockwise) when the finger moves along and remains on the wheel. Upon wheel position detection, the corresponding LEDs surrounding the wheel light up accordingly. Each individual tap on the center capacitive touch button toggles the center LED.

After a short time without any touch activity (on the wheel or on the center button), the application returns to sleep mode, enabling only the proximity sensor periodically.

A 9600-baud UART link is also implemented using software Timer\_A to provide application and capacitive sensing data to the PC via the UART-USB back channel. The application sends UART data on events such as wake up, sleep, touch, or gesture.

For more detailed information on the firmware project, see the source code and the associated ReadMe.txt.

### 4.1 Import Project in CCS

To import the project into CCS:

1. Open CCS.
2. Select a new project workspace outside of the project folder <sup>(1)</sup>.
3. Select Project-->Import Existing Project.
4. Browse to the [PROJECT\_ROOT]\CCS folder.
5. Make sure that "Copy projects into workspace" is not checked.
6. Click Finish

---

**NOTE:** For CCS, while project root is in the outer directory, the CCS project files are located inside CCS. To enable the portability of the project, the file macros.ini is created to define the root. Additionally, all project code files (.c, .h) are added as linked resources with their relative path to the project root.

---

### 4.2 Open Project and Workspace in IAR Embedded Workbench

To open the project in IAR Embedded Workbench:

1. Browse to the [PROJECT\_ROOT]\IAR folder.
2. Open the Sense\_BoosterPack\_UserExperience.eww workspace.

<sup>(1)</sup> The workspace should be in an independent folder, not containing or contained by the project/package folder.

### 4.3 Capacitive Touch Software Library

The Capacitive Touch Software Library ([CAPSENSELIBRARY](#)) is a configurable tool to abstract the various peripheral settings from the application and perform several capacitive touch functions through API calls. The following describes the configuration of the library to support the Capacitive Touch BoosterPack, the methodology to calibrate the different elements, and how the API calls are used in the application to create the user experience.

#### 1. Configuration

The first step in the configuration process is identifying the methodology used to measure the capacitance. For the Capacitive Touch BoosterPack, the goal is to highlight the new PinOsc feature; therefore, an RO implementation is chosen, and the relaxation oscillator is implemented with the PinOsc. The RO implementation requires two timers (hardware or software timers): an interval timer (gate) and a frequency counter. The frequency counter is implemented with the Timer\_A0 peripheral, and the interval timer is implemented with the WDT+.

The Capacitive Touch BoosterPack is represented in the various structures defined in the file structure.c. The element structures define the GPIO and the performance characteristics of each element. The GPIOs are defined first, the appropriate sensor characteristics are defined, and the performance characteristics are measured and added.

The sensor structure groups elements as appropriate and identifies the measurement characteristic for that group, namely the interval period. For the RO method, increasing the interval time increases the sensitivity; however, this is at the cost of response time, which is critical for supporting the PC GUI in this application.

The proximity sensor uses an SMCLK of 125 kHz. For the button and wheel, the frequency is increased to 1 MHz. The interval count is 8192: 8.192-ms gate time for the button and wheel elements and 65.5-ms gate time for the proximity element. The wheel is a special kind of sensor in which each element contributes to the sensor performance. The wheel is made up of four elements divided into 64 points or sections and requires that the cumulative response exceed 75 percent. This percentage is based upon the normalized response where meeting the threshold would represent 0% and the maximum response would represent 100%. This is to account for cases when the interaction is near the edges of the wheel instead of the middle.

#### 2. Calibration

The calibration of the middle button and the proximity sensor are relatively straight forward, because the desired output is a binary indication of whether or not the threshold is exceeded. Using a controlled test fixture to represent the minimum touch (distance in the case of the proximity sensor), the values are recorded and input as the threshold value in the element structure.

The calibration for the wheel is more complicated, as several measurements are required at various positions. See the "Sensor Arrays: Wheels and Sliders" section in the *Capacitive Touch Software Library User's Guide* ([SLAA490](#)) for a detailed explanation.

The calibration values for each element are recorded in the element structure in the file structure.c.



### 3. API Calls

There are five API functions that are called several times in the application.

- The TI\_CAPT\_Init\_Baseline and TI\_CAPT\_Update\_Baseline functions initialize and update, respectively, the baseline tracking performed by the library. Typically, these functions are called at the beginning of an application or after long periods of inactivity. In this application, the initialization and updates are performed after a power-up sequence and before a transition from the sleep (polling proximity sensor only) to active (polling button and wheel only). These functions are used at the transitions, because it is unknown how old the previous measurements are and if these still represent the current environment.
- The TI\_CAPT\_Custom function measures the proximity sensor. The variable dCnt is updated with the measured value. In this application, this variable is compared to a threshold value. Because this is a simple On/Off function, the TI\_CAPT\_Button function could have been used but, for demonstration purposes, the TI\_CAPT\_Custom function was chosen. When a threshold crossing is detected, an LED sequence is started, and the application transitions to the active state (polling the wheel and middle button). One possible enhancement of the proximity sensor application is to enable several different thresholds and indicate how close the user is with the LEDs on the BoosterPack.
- The TI\_CAPT\_Button function determines if the middle button has been detected. This function returns either a 1 to indicate a threshold crossing (touch) or a 0 to indicate that no touch was detected. The middle LED is illuminated to indicate a touch.
- The TI\_CAPT\_Wheel function indicates the position on the wheel if it was touched or returns a defined value if no touch was detected. This information is used by the application for gesture recognition (which is sent to the PC) and for illuminating the eight LEDs around the board.

For more information on the library, see the *Capacitive Touch Software Library User's Guide* ([SLAA490](#)).

## 5 LaunchPad Capacitive Touch BoosterPack User Experience Software

### 5.1 LaunchPad Capacitive Touch BoosterPack User Experience GUI

Written in Processing, this Windows PC GUI application communicates with the LaunchPad to receive specific capacitive touch data from the LaunchPad Capacitive Touch BoosterPack and provides the visualization of that data in the GUI. Processing is a platform-independent open-source programming language and environment, specializing in visual arts, graphics, and interactive applications.

The GUI uses a small .NET utility (FindAppUART.exe) to automatically detect a proper LaunchPad/430Emulator device connected to the PC USB port. Upon correct USB COM port discovery, the application initiates a 9600-baud UART connection and starts receiving data.

The GUI processes event and capacitive touch data and visualizes the data on the GUI in a 16-slice wheel formation. Individual touches as well as gestures can be tracked in real time.

Further description of the behavior can be found in [Section 2.3.2](#) and the ReadMe.txt in the project source code directory.

The application also takes advantage of the serial library for USB COM serial communication, and the sound library pitaru.sonia\_v2\_9 (available at <http://sonia.pitaru.com/download.htm>) for audio effects.

#### 5.1.1 Requirements

The following utilities and libraries are required when modifying the User Experience source code.

- Processing ([www.processing.org](http://www.processing.org))
- Serial library (included with Processing installation)
- pitaru.sonia\_v2\_9 sound library ([sonia.pitaru.com/download.htm](http://sonia.pitaru.com/download.htm))
- FindAppUART.exe (included .NET utility)

### 5.2 MediaPad

The program MediaPad, written using Visual Studio, translates capacitive touch data from from the LaunchPad Capacitive Touch BoosterPack into Microsoft Windows virtual keystrokes for Windows media control. The application implements auto-detection code that automatically finds a LaunchPad-compatible USB COM port before establishing the proper connection. Further behavior of the application is described in [Section 2.3.2](#) and the ReadMe.txt in the project source code directory.

#### 5.2.1 Requirements

When modifying the MediaPad source code, Microsoft Visual C++ 2010 Redistributable Package (included in any version of Visual Studio 2010) (available at <http://www.microsoft.com/downloads>) is required.

### 5.3 UART Communication Protocol

For each event (wake up, go to sleep, touch/press, or gesture), a UART packet of two bytes is sent via the application UART backchannel of the LaunchPad. The packets are specified as follows:

- WAKE UP [due to proximity sensor detection]: 0xBE 0xEF
- SLEEP [after period of inactivity]: 0xDE 0xAD
- CENTER BUTTON PRESS: 0x80 0x80
- WHEEL POSITION TOUCH/PRESS: 0x3z 0x3z  
z = touch position 0x0 to 0xF, one nibble
- GESTURE START: 0xFC 0x2z  
z = touch position 0x0 to 0xF, one nibble
- GESTURE STOP: 0xFB 0xFB
- GESTURE and GESTURE END POSITION : 0xGG 0x2  
GG = a binary number  
MSB is direction: 0 = clockwise, 1 = counter-clockwise  
7 LSBs = count of gesture movement  
z = ending position of the immediate gesture, 0x0 to 0xF, one nibble.

The PC application can receive and decipher the UART information to translate it into appropriate actions.

## 6 Frequently Asked Questions (FAQ), Tips, and Tricks

1. The LaunchPad is unable to program the MSP430G2452.  
Some of the revision 1.4 LaunchPad kits must have a firmware update to support the MSP430G2452 devices. Update the LaunchPad firmware with the application provided at [processors.wiki.ti.com/index.php/MSP430\\_LaunchPad\\_Firmware\\_Update](http://processors.wiki.ti.com/index.php/MSP430_LaunchPad_Firmware_Update).
2. The capacitive-touch I/Os are not working when the LaunchPad is picked up.  
Place the board flat on a table or other stable horizontal surface before using the Capacitive Touch BoosterPack. Do not hold the board while it is in use; the contacts on the back of the Capacitive Touch BoosterPack may be touched, which prevents the capacitive-touch I/Os from detecting user interaction.
3. My application is not able to light up all the LEDs.  
The LEDs around the wheel are multiplexed; therefore, they cannot all be turned on simultaneously. Its required to use a time-shared approach to light up all LEDs at once (see [Section 3.1](#)).
4. The button or the wheel is sometimes fails to detect the first touch.  
Make sure to wave your hand 3 to 5 cm above the board to wake the device before actually touch the wheel or button. The capacitive sensors are activated immediately after the wake-up sequence is finished.
5. Windows Media Player is not starting.  
Loading Windows Media Player might take some time, depending on the system. On some systems, another media player program is associated with the Windows media keys.

## 7 References

The primary sources of MSP430 information are the device-specific data sheets and user's guides. The most up-to-date versions of the documents can be found at the Texas Instruments MSP430 web page. [1] All MSP430 LaunchPad and BoosterPack information can be found at the MSP430 LaunchPad wiki. [2]

The MSP430 LaunchPad and Value Line devices are supported in the latest versions of Code Composer Studio [3] and IAR Embedded Workbench [4]. In-depth details on the supported IDEs (CCS and IAR) can be found in the documentation folders of the IDE installation. IAR tool documentation (Workbench/C-SPY, the assembler, the C compiler, the linker, and the library) is in the common\doc and 430\doc folders. CCS documents is in the msp430\doc folder under the CCS installation path.

The FET user's guides [5] [6] also include detailed information on how to set up a project for the MSP430 using CCS or IAR Embedded Workbench. These user's guide are also included in the latest IDE releases.

1. <http://www.ti.com/msp430>
2. [http://processors.wiki.ti.com/index.php/MSP430\\_LaunchPad\\_\(MSP-EXP430G2\)](http://processors.wiki.ti.com/index.php/MSP430_LaunchPad_(MSP-EXP430G2))
3. [http://processors.wiki.ti.com/index.php/Download\\_CCS](http://processors.wiki.ti.com/index.php/Download_CCS)
4. <http://focus.ti.com/docs/toolsw/folders/print/iar-kickstart.html>
5. *Code Composer Studio v4.2 for MSP430(tm) User's Guide* ([SLAU157](#))
6. *IAR Embedded Workbench Version 3+ for MSP430(tm) User's Guide* ([SLAU138](#))
7. Capacitive Touch Software Library (CAPSENSELIBRARY) (<http://www.ti.com/tool/capsenselibrary>)
8. *Capacitive Touch Software Library User's Guide* ([SLAA490](#))
9. *Capacitive Touch Software Library Quick Start Guide* ([SLAA491](#))
10. Capacitive Touch BoosterPack Software and Design Documentation ([SLAC490](#))

## 8 Schematics and PCB Layout

### 8.1 Schematics

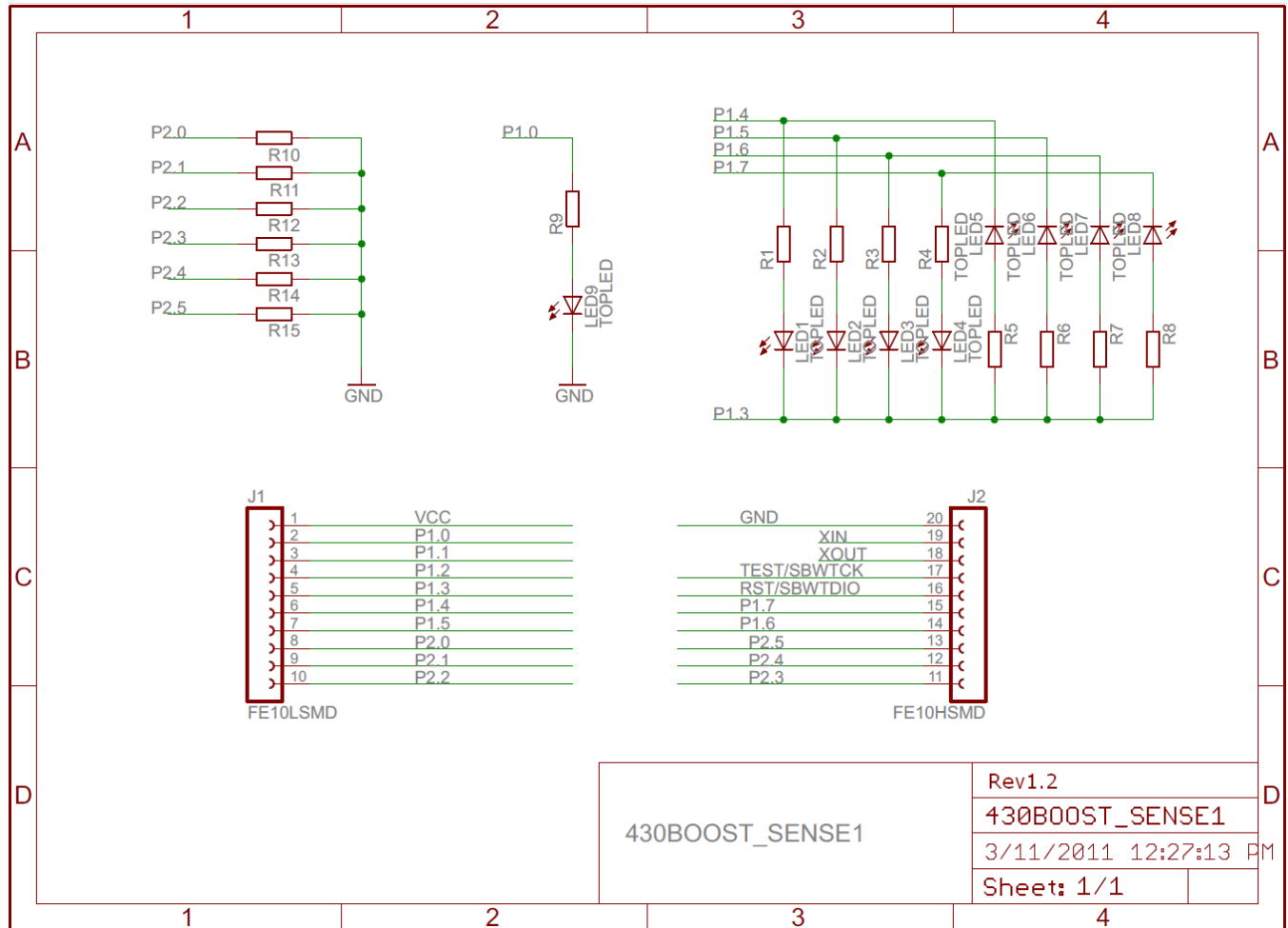

Figure 10. Capacitive Touch BoosterPack Schematic

## 8.2 PCB Layout

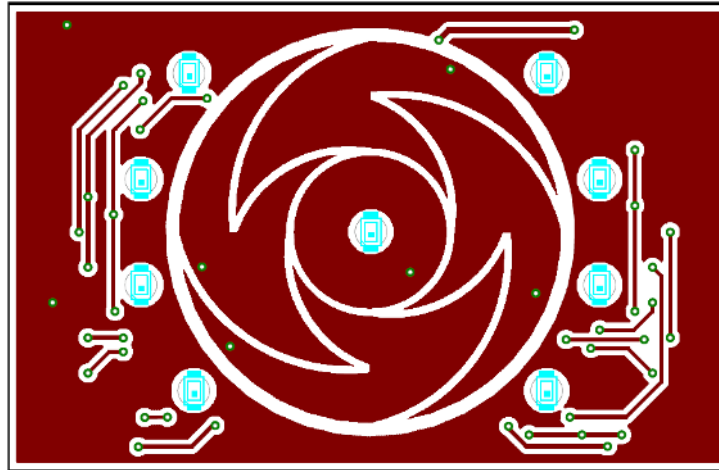

Figure 11. Capacitive Touch BoosterPack Layout, Top Layer

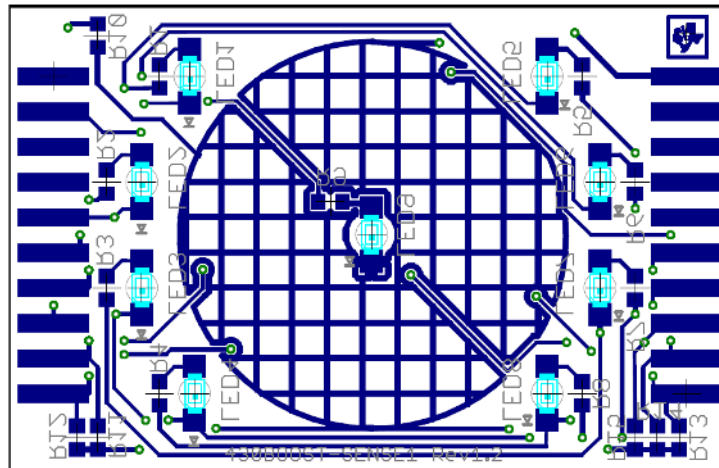

Figure 12. Capacitive Touch BoosterPack Layout, Bottom Layer and Silkscreen

## 8.3 Bill of Materials (BOM)

Table 2. Bill of Materials

| Pos. | Ref Name     | Number per Board | Description                        |
|------|--------------|------------------|------------------------------------|
| 1    | R1 to R8     | 8                | 390-Ω SMD0603 resistor             |
| 2    | R9           | 1                | 180-Ω SMD0603 resistor             |
| 3    | LED1 to LED8 | 8                | Top LED red wtr clr 631NM 1206     |
| 4    | LED9         | 1                | LED white round diffused 1206      |
| 5    | J1, J2       | 2                | Female header SSM-110-L-SV 2.54 mm |
| 6    | R10 to R15   | 0                | SMD0603 resistor (not populated)   |

## Revision History

| <b>Changes from A Revision (September 2011) to B Revision</b> | <b>Page</b> |
|---|-------------|
|---|-------------|

---

- Removed all variations of "TouchSense" (a trademark of Immersion Corporation) throughout document ..... [5](#)
- 

NOTE: Page numbers for previous revisions may differ from page numbers in the current version.

## STANDARD TERMS AND CONDITIONS FOR EVALUATION MODULES

1. *Delivery:* TI delivers TI evaluation boards, kits, or modules, including any accompanying demonstration software, components, or documentation (collectively, an "EVM" or "EVMs") to the User ("User") in accordance with the terms and conditions set forth herein. Acceptance of the EVM is expressly subject to the following terms and conditions.
  - 1.1 EVMs are intended solely for product or software developers for use in a research and development setting to facilitate feasibility evaluation, experimentation, or scientific analysis of TI semiconductors products. EVMs have no direct function and are not finished products. EVMs shall not be directly or indirectly assembled as a part or subassembly in any finished product. For clarification, any software or software tools provided with the EVM ("Software") shall not be subject to the terms and conditions set forth herein but rather shall be subject to the applicable terms and conditions that accompany such Software
  - 1.2 EVMs are not intended for consumer or household use. EVMs may not be sold, sublicensed, leased, rented, loaned, assigned, or otherwise distributed for commercial purposes by Users, in whole or in part, or used in any finished product or production system.
2. *Limited Warranty and Related Remedies/Disclaimers:*
  - 2.1 These terms and conditions do not apply to Software. The warranty, if any, for Software is covered in the applicable Software License Agreement.
  - 2.2 TI warrants that the TI EVM will conform to TI's published specifications for ninety (90) days after the date TI delivers such EVM to User. Notwithstanding the foregoing, TI shall not be liable for any defects that are caused by neglect, misuse or mistreatment by an entity other than TI, including improper installation or testing, or for any EVMs that have been altered or modified in any way by an entity other than TI. Moreover, TI shall not be liable for any defects that result from User's design, specifications or instructions for such EVMs. Testing and other quality control techniques are used to the extent TI deems necessary or as mandated by government requirements. TI does not test all parameters of each EVM.
  - 2.3 If any EVM fails to conform to the warranty set forth above, TI's sole liability shall be at its option to repair or replace such EVM, or credit User's account for such EVM. TI's liability under this warranty shall be limited to EVMs that are returned during the warranty period to the address designated by TI and that are determined by TI not to conform to such warranty. If TI elects to repair or replace such EVM, TI shall have a reasonable time to repair such EVM or provide replacements. Repaired EVMs shall be warranted for the remainder of the original warranty period. Replaced EVMs shall be warranted for a new full ninety (90) day warranty period.
3. *Regulatory Notices:*
  - 3.1 *United States*
    - 3.1.1 *Notice applicable to EVMs not FCC-Approved:*

This kit is designed to allow product developers to evaluate electronic components, circuitry, or software associated with the kit to determine whether to incorporate such items in a finished product and software developers to write software applications for use with the end product. This kit is not a finished product and when assembled may not be resold or otherwise marketed unless all required FCC equipment authorizations are first obtained. Operation is subject to the condition that this product not cause harmful interference to licensed radio stations and that this product accept harmful interference. Unless the assembled kit is designed to operate under part 15, part 18 or part 95 of this chapter, the operator of the kit must operate under the authority of an FCC license holder or must secure an experimental authorization under part 5 of this chapter.
    - 3.1.2 *For EVMs annotated as FCC – FEDERAL COMMUNICATIONS COMMISSION Part 15 Compliant:*

### CAUTION

This device complies with part 15 of the FCC Rules. Operation is subject to the following two conditions: (1) This device may not cause harmful interference, and (2) this device must accept any interference received, including interference that may cause undesired operation.

Changes or modifications not expressly approved by the party responsible for compliance could void the user's authority to operate the equipment.

### FCC Interference Statement for Class A EVM devices

*NOTE: This equipment has been tested and found to comply with the limits for a Class A digital device, pursuant to part 15 of the FCC Rules. These limits are designed to provide reasonable protection against harmful interference when the equipment is operated in a commercial environment. This equipment generates, uses, and can radiate radio frequency energy and, if not installed and used in accordance with the instruction manual, may cause harmful interference to radio communications. Operation of this equipment in a residential area is likely to cause harmful interference in which case the user will be required to correct the interference at his own expense.*



## FCC Interference Statement for Class B EVM devices

*NOTE: This equipment has been tested and found to comply with the limits for a Class B digital device, pursuant to part 15 of the FCC Rules. These limits are designed to provide reasonable protection against harmful interference in a residential installation. This equipment generates, uses and can radiate radio frequency energy and, if not installed and used in accordance with the instructions, may cause harmful interference to radio communications. However, there is no guarantee that interference will not occur in a particular installation. If this equipment does cause harmful interference to radio or television reception, which can be determined by turning the equipment off and on, the user is encouraged to try to correct the interference by one or more of the following measures:*

- Reorient or relocate the receiving antenna.
- Increase the separation between the equipment and receiver.
- Connect the equipment into an outlet on a circuit different from that to which the receiver is connected.
- Consult the dealer or an experienced radio/TV technician for help.

### 3.2 Canada

3.2.1 For EVMs issued with an Industry Canada Certificate of Conformance to RSS-210

#### Concerning EVMs Including Radio Transmitters:

This device complies with Industry Canada license-exempt RSS standard(s). Operation is subject to the following two conditions: (1) this device may not cause interference, and (2) this device must accept any interference, including interference that may cause undesired operation of the device.

#### Concernant les EVMs avec appareils radio:

Le présent appareil est conforme aux CNR d'Industrie Canada applicables aux appareils radio exempts de licence. L'exploitation est autorisée aux deux conditions suivantes: (1) l'appareil ne doit pas produire de brouillage, et (2) l'utilisateur de l'appareil doit accepter tout brouillage radioélectrique subi, même si le brouillage est susceptible d'en compromettre le fonctionnement.

#### Concerning EVMs Including Detachable Antennas:

Under Industry Canada regulations, this radio transmitter may only operate using an antenna of a type and maximum (or lesser) gain approved for the transmitter by Industry Canada. To reduce potential radio interference to other users, the antenna type and its gain should be so chosen that the equivalent isotropically radiated power (e.i.r.p.) is not more than that necessary for successful communication. This radio transmitter has been approved by Industry Canada to operate with the antenna types listed in the user guide with the maximum permissible gain and required antenna impedance for each antenna type indicated. Antenna types not included in this list, having a gain greater than the maximum gain indicated for that type, are strictly prohibited for use with this device.

#### Concernant les EVMs avec antennes détachables

Conformément à la réglementation d'Industrie Canada, le présent émetteur radio peut fonctionner avec une antenne d'un type et d'un gain maximal (ou inférieur) approuvé pour l'émetteur par Industrie Canada. Dans le but de réduire les risques de brouillage radioélectrique à l'intention des autres utilisateurs, il faut choisir le type d'antenne et son gain de sorte que la puissance isotrope rayonnée équivalente (p.i.r.e.) ne dépasse pas l'intensité nécessaire à l'établissement d'une communication satisfaisante. Le présent émetteur radio a été approuvé par Industrie Canada pour fonctionner avec les types d'antenne énumérés dans le manuel d'usage et ayant un gain admissible maximal et l'impédance requise pour chaque type d'antenne. Les types d'antenne non inclus dans cette liste, ou dont le gain est supérieur au gain maximal indiqué, sont strictement interdits pour l'exploitation de l'émetteur.

### 3.3 Japan

3.3.1 *Notice for EVMs delivered in Japan:* Please see [http://www.tij.co.jp/lstds/ti\\_ja/general/eStore/notice\\_01.page](http://www.tij.co.jp/lstds/ti_ja/general/eStore/notice_01.page) 日本国内に輸入される評価用キット、ボードについては、次のところをご覧ください。  
[http://www.tij.co.jp/lstds/ti\\_ja/general/eStore/notice\\_01.page](http://www.tij.co.jp/lstds/ti_ja/general/eStore/notice_01.page)

3.3.2 *Notice for Users of EVMs Considered "Radio Frequency Products" in Japan:* EVMs entering Japan may not be certified by TI as conforming to Technical Regulations of Radio Law of Japan.

If User uses EVMs in Japan, not certified to Technical Regulations of Radio Law of Japan, User is required by Radio Law of Japan to follow the instructions below with respect to EVMs:

1. Use EVMs in a shielded room or any other test facility as defined in the notification #173 issued by Ministry of Internal Affairs and Communications on March 28, 2006, based on Sub-section 1.1 of Article 6 of the Ministry's Rule for Enforcement of Radio Law of Japan,
2. Use EVMs only after User obtains the license of Test Radio Station as provided in Radio Law of Japan with respect to EVMs, or
3. Use of EVMs only after User obtains the Technical Regulations Conformity Certification as provided in Radio Law of Japan with respect to EVMs. Also, do not transfer EVMs, unless User gives the same notice above to the transferee. Please note that if User does not follow the instructions above, User will be subject to penalties of Radio Law of Japan.

【無線電波を送信する製品の開発キットをお使いになる際の注意事項】 開発キットの中には技術基準適合証明を受けていないものがあります。技術適合証明を受けていないもののご使用に際しては、電波法遵守のため、以下のいずれかの措置を取っていただく必要がありますのでご注意ください。

1. 電波法施行規則第6条第1項第1号に基づく平成18年3月28日総務省告示第173号で定められた電波暗室等の試験設備でご使用いただく。
2. 実験局の免許を取得後ご使用いただく。
3. 技術基準適合証明を取得後ご使用いただく。

なお、本製品は、上記の「ご使用にあたっての注意」を譲渡先、移転先に通知しない限り、譲渡、移転できないものとします。

上記を遵守頂けない場合は、電波法の罰則が適用される可能性があることをご留意ください。日本テキサス・インスツルメンツ株式会社

東京都新宿区西新宿 6 丁目 2 4 番 1 号

西新宿三井ビル

3.3.3 *Notice for EVMs for Power Line Communication:* Please see [http://www.tij.co.jp/llds/ti\\_ja/general/eStore/notice\\_02.page](http://www.tij.co.jp/llds/ti_ja/general/eStore/notice_02.page)

電力線搬送波通信についての開発キットをお使いになる際の注意事項については、次のところをご覧ください。[http://www.tij.co.jp/llds/ti\\_ja/general/eStore/notice\\_02.page](http://www.tij.co.jp/llds/ti_ja/general/eStore/notice_02.page)

#### 4 *EVM Use Restrictions and Warnings:*

4.1 EVMS ARE NOT FOR USE IN FUNCTIONAL SAFETY AND/OR SAFETY CRITICAL EVALUATIONS, INCLUDING BUT NOT LIMITED TO EVALUATIONS OF LIFE SUPPORT APPLICATIONS.

4.2 User must read and apply the user guide and other available documentation provided by TI regarding the EVM prior to handling or using the EVM, including without limitation any warning or restriction notices. The notices contain important safety information related to, for example, temperatures and voltages.

#### 4.3 *Safety-Related Warnings and Restrictions:*

4.3.1 User shall operate the EVM within TI's recommended specifications and environmental considerations stated in the user guide, other available documentation provided by TI, and any other applicable requirements and employ reasonable and customary safeguards. Exceeding the specified performance ratings and specifications (including but not limited to input and output voltage, current, power, and environmental ranges) for the EVM may cause personal injury or death, or property damage. If there are questions concerning performance ratings and specifications, User should contact a TI field representative prior to connecting interface electronics including input power and intended loads. Any loads applied outside of the specified output range may also result in unintended and/or inaccurate operation and/or possible permanent damage to the EVM and/or interface electronics. Please consult the EVM user guide prior to connecting any load to the EVM output. If there is uncertainty as to the load specification, please contact a TI field representative. During normal operation, even with the inputs and outputs kept within the specified allowable ranges, some circuit components may have elevated case temperatures. These components include but are not limited to linear regulators, switching transistors, pass transistors, current sense resistors, and heat sinks, which can be identified using the information in the associated documentation. When working with the EVM, please be aware that the EVM may become very warm.

4.3.2 EVMs are intended solely for use by technically qualified, professional electronics experts who are familiar with the dangers and application risks associated with handling electrical mechanical components, systems, and subsystems. User assumes all responsibility and liability for proper and safe handling and use of the EVM by User or its employees, affiliates, contractors or designees. User assumes all responsibility and liability to ensure that any interfaces (electronic and/or mechanical) between the EVM and any human body are designed with suitable isolation and means to safely limit accessible leakage currents to minimize the risk of electrical shock hazard. User assumes all responsibility and liability for any improper or unsafe handling or use of the EVM by User or its employees, affiliates, contractors or designees.

4.4 User assumes all responsibility and liability to determine whether the EVM is subject to any applicable international, federal, state, or local laws and regulations related to User's handling and use of the EVM and, if applicable, User assumes all responsibility and liability for compliance in all respects with such laws and regulations. User assumes all responsibility and liability for proper disposal and recycling of the EVM consistent with all applicable international, federal, state, and local requirements.

5. *Accuracy of Information:* To the extent TI provides information on the availability and function of EVMs, TI attempts to be as accurate as possible. However, TI does not warrant the accuracy of EVM descriptions, EVM availability or other information on its websites as accurate, complete, reliable, current, or error-free.

6. *Disclaimers:*
- 6.1 EXCEPT AS SET FORTH ABOVE, EVMS AND ANY WRITTEN DESIGN MATERIALS PROVIDED WITH THE EVM (AND THE DESIGN OF THE EVM ITSELF) ARE PROVIDED "AS IS" AND "WITH ALL FAULTS." TI DISCLAIMS ALL OTHER WARRANTIES, EXPRESS OR IMPLIED, REGARDING SUCH ITEMS, INCLUDING BUT NOT LIMITED TO ANY IMPLIED WARRANTIES OF MERCHANTABILITY OR FITNESS FOR A PARTICULAR PURPOSE OR NON-INFRINGEMENT OF ANY THIRD PARTY PATENTS, COPYRIGHTS, TRADE SECRETS OR OTHER INTELLECTUAL PROPERTY RIGHTS.
- 6.2 EXCEPT FOR THE LIMITED RIGHT TO USE THE EVM SET FORTH HEREIN, NOTHING IN THESE TERMS AND CONDITIONS SHALL BE CONSTRUED AS GRANTING OR CONFERRING ANY RIGHTS BY LICENSE, PATENT, OR ANY OTHER INDUSTRIAL OR INTELLECTUAL PROPERTY RIGHT OF TI, ITS SUPPLIERS/LICENSORS OR ANY OTHER THIRD PARTY, TO USE THE EVM IN ANY FINISHED END-USER OR READY-TO-USE FINAL PRODUCT, OR FOR ANY INVENTION, DISCOVERY OR IMPROVEMENT MADE, CONCEIVED OR ACQUIRED PRIOR TO OR AFTER DELIVERY OF THE EVM.
7. *USER'S INDEMNITY OBLIGATIONS AND REPRESENTATIONS.* USER WILL DEFEND, INDEMNIFY AND HOLD TI, ITS LICENSORS AND THEIR REPRESENTATIVES HARMLESS FROM AND AGAINST ANY AND ALL CLAIMS, DAMAGES, LOSSES, EXPENSES, COSTS AND LIABILITIES (COLLECTIVELY, "CLAIMS") ARISING OUT OF OR IN CONNECTION WITH ANY HANDLING OR USE OF THE EVM THAT IS NOT IN ACCORDANCE WITH THESE TERMS AND CONDITIONS. THIS OBLIGATION SHALL APPLY WHETHER CLAIMS ARISE UNDER STATUTE, REGULATION, OR THE LAW OF TORT, CONTRACT OR ANY OTHER LEGAL THEORY, AND EVEN IF THE EVM FAILS TO PERFORM AS DESCRIBED OR EXPECTED.
8. *Limitations on Damages and Liability:*
- 8.1 *General Limitations.* IN NO EVENT SHALL TI BE LIABLE FOR ANY SPECIAL, COLLATERAL, INDIRECT, PUNITIVE, INCIDENTAL, CONSEQUENTIAL, OR EXEMPLARY DAMAGES IN CONNECTION WITH OR ARISING OUT OF THESE TERMS AND CONDITIONS OR THE USE OF THE EVMS PROVIDED HEREUNDER, REGARDLESS OF WHETHER TI HAS BEEN ADVISED OF THE POSSIBILITY OF SUCH DAMAGES. EXCLUDED DAMAGES INCLUDE, BUT ARE NOT LIMITED TO, COST OF REMOVAL OR REINSTALLATION, ANCILLARY COSTS TO THE PROCUREMENT OF SUBSTITUTE GOODS OR SERVICES, RETESTING, OUTSIDE COMPUTER TIME, LABOR COSTS, LOSS OF GOODWILL, LOSS OF PROFITS, LOSS OF SAVINGS, LOSS OF USE, LOSS OF DATA, OR BUSINESS INTERRUPTION. NO CLAIM, SUIT OR ACTION SHALL BE BROUGHT AGAINST TI MORE THAN ONE YEAR AFTER THE RELATED CAUSE OF ACTION HAS OCCURRED.
- 8.2 *Specific Limitations.* IN NO EVENT SHALL TI'S AGGREGATE LIABILITY FROM ANY WARRANTY OR OTHER OBLIGATION ARISING OUT OF OR IN CONNECTION WITH THESE TERMS AND CONDITIONS, OR ANY USE OF ANY TI EVM PROVIDED HEREUNDER, EXCEED THE TOTAL AMOUNT PAID TO TI FOR THE PARTICULAR UNITS SOLD UNDER THESE TERMS AND CONDITIONS WITH RESPECT TO WHICH LOSSES OR DAMAGES ARE CLAIMED. THE EXISTENCE OF MORE THAN ONE CLAIM AGAINST THE PARTICULAR UNITS SOLD TO USER UNDER THESE TERMS AND CONDITIONS SHALL NOT ENLARGE OR EXTEND THIS LIMIT.
9. *Return Policy.* Except as otherwise provided, TI does not offer any refunds, returns, or exchanges. Furthermore, no return of EVM(s) will be accepted if the package has been opened and no return of the EVM(s) will be accepted if they are damaged or otherwise not in a resalable condition. If User feels it has been incorrectly charged for the EVM(s) it ordered or that delivery violates the applicable order, User should contact TI. All refunds will be made in full within thirty (30) working days from the return of the components(s), excluding any postage or packaging costs.
10. *Governing Law:* These terms and conditions shall be governed by and interpreted in accordance with the laws of the State of Texas, without reference to conflict-of-laws principles. User agrees that non-exclusive jurisdiction for any dispute arising out of or relating to these terms and conditions lies within courts located in the State of Texas and consents to venue in Dallas County, Texas. Notwithstanding the foregoing, any judgment may be enforced in any United States or foreign court, and TI may seek injunctive relief in any United States or foreign court.

Mailing Address: Texas Instruments, Post Office Box 655303, Dallas, Texas 75265  
Copyright © 2015, Texas Instruments Incorporated

## IMPORTANT NOTICE

Texas Instruments Incorporated and its subsidiaries (TI) reserve the right to make corrections, enhancements, improvements and other changes to its semiconductor products and services per JESD46, latest issue, and to discontinue any product or service per JESD48, latest issue. Buyers should obtain the latest relevant information before placing orders and should verify that such information is current and complete. All semiconductor products (also referred to herein as "components") are sold subject to TI's terms and conditions of sale supplied at the time of order acknowledgment.

TI warrants performance of its components to the specifications applicable at the time of sale, in accordance with the warranty in TI's terms and conditions of sale of semiconductor products. Testing and other quality control techniques are used to the extent TI deems necessary to support this warranty. Except where mandated by applicable law, testing of all parameters of each component is not necessarily performed.

TI assumes no liability for applications assistance or the design of Buyers' products. Buyers are responsible for their products and applications using TI components. To minimize the risks associated with Buyers' products and applications, Buyers should provide adequate design and operating safeguards.

TI does not warrant or represent that any license, either express or implied, is granted under any patent right, copyright, mask work right, or other intellectual property right relating to any combination, machine, or process in which TI components or services are used. Information published by TI regarding third-party products or services does not constitute a license to use such products or services or a warranty or endorsement thereof. Use of such information may require a license from a third party under the patents or other intellectual property of the third party, or a license from TI under the patents or other intellectual property of TI.

Reproduction of significant portions of TI information in TI data books or data sheets is permissible only if reproduction is without alteration and is accompanied by all associated warranties, conditions, limitations, and notices. TI is not responsible or liable for such altered documentation. Information of third parties may be subject to additional restrictions.

Resale of TI components or services with statements different from or beyond the parameters stated by TI for that component or service voids all express and any implied warranties for the associated TI component or service and is an unfair and deceptive business practice. TI is not responsible or liable for any such statements.

Buyer acknowledges and agrees that it is solely responsible for compliance with all legal, regulatory and safety-related requirements concerning its products, and any use of TI components in its applications, notwithstanding any applications-related information or support that may be provided by TI. Buyer represents and agrees that it has all the necessary expertise to create and implement safeguards which anticipate dangerous consequences of failures, monitor failures and their consequences, lessen the likelihood of failures that might cause harm and take appropriate remedial actions. Buyer will fully indemnify TI and its representatives against any damages arising out of the use of any TI components in safety-critical applications.

In some cases, TI components may be promoted specifically to facilitate safety-related applications. With such components, TI's goal is to help enable customers to design and create their own end-product solutions that meet applicable functional safety standards and requirements. Nonetheless, such components are subject to these terms.

No TI components are authorized for use in FDA Class III (or similar life-critical medical equipment) unless authorized officers of the parties have executed a special agreement specifically governing such use.

Only those TI components which TI has specifically designated as military grade or "enhanced plastic" are designed and intended for use in military/aerospace applications or environments. Buyer acknowledges and agrees that any military or aerospace use of TI components which have **not** been so designated is solely at the Buyer's risk, and that Buyer is solely responsible for compliance with all legal and regulatory requirements in connection with such use.

TI has specifically designated certain components as meeting ISO/TS16949 requirements, mainly for automotive use. In any case of use of non-designated products, TI will not be responsible for any failure to meet ISO/TS16949.

### Products

|                              |  |
|------------------------------|--|
| Audio                        | <a href="http://www.ti.com/audio">www.ti.com/audio</a>                               |
| Amplifiers                   | <a href="http://amplifier.ti.com">amplifier.ti.com</a>                               |
| Data Converters              | <a href="http://dataconverter.ti.com">dataconverter.ti.com</a>                       |
| DLP® Products                | <a href="http://www.dlp.com">www.dlp.com</a>   |
| DSP                          | <a href="http://dsp.ti.com">dsp.ti.com</a>   |
| Clocks and Timers            | <a href="http://www.ti.com/clocks">www.ti.com/clocks</a>                             |
| Interface                    | <a href="http://interface.ti.com">interface.ti.com</a>                               |
| Logic                        | <a href="http://logic.ti.com">logic.ti.com</a>                                       |
| Power Mgmt                   | <a href="http://power.ti.com">power.ti.com</a>                                       |
| Microcontrollers             | <a href="http://microcontroller.ti.com">microcontroller.ti.com</a>                   |
| RFID                         | <a href="http://www.ti-rfid.com">www.ti-rfid.com</a>                                 |
| OMAP Applications Processors | <a href="http://www.ti.com/omap">www.ti.com/omap</a>                                 |
| Wireless Connectivity        | <a href="http://www.ti.com/wirelessconnectivity">www.ti.com/wirelessconnectivity</a> |

### Applications

|                               |  |
|-------------------------------|--|
| Automotive and Transportation | <a href="http://www.ti.com/automotive">www.ti.com/automotive</a>                         |
| Communications and Telecom    | <a href="http://www.ti.com/communications">www.ti.com/communications</a>                 |
| Computers and Peripherals     | <a href="http://www.ti.com/computers">www.ti.com/computers</a>                           |
| Consumer Electronics          | <a href="http://www.ti.com/consumer-apps">www.ti.com/consumer-apps</a>                   |
| Energy and Lighting           | <a href="http://www.ti.com/energy">www.ti.com/energy</a>                                 |
| Industrial                    | <a href="http://www.ti.com/industrial">www.ti.com/industrial</a>                         |
| Medical                       | <a href="http://www.ti.com/medical">www.ti.com/medical</a>                               |
| Security                      | <a href="http://www.ti.com/security">www.ti.com/security</a>                             |
| Space, Avionics and Defense   | <a href="http://www.ti.com/space-avionics-defense">www.ti.com/space-avionics-defense</a> |
| Video and Imaging             | <a href="http://www.ti.com/video">www.ti.com/video</a>                                   |

### TI E2E Community

[e2e.ti.com](http://e2e.ti.com)