

2-1670916-1 ✓ ACTIVE

AMP | MCON Interconnection System

TE Internal #: 2-1670916-1

Housing for Female Terminals, Wire-to-Wire, 2 Position, .157 in [4 mm] Centerline, Sealable, Natural, Wire & Cable, Power, MCON Interconnection System

[View on TE.com >](#)



Connectors > Automotive Connectors > Automotive Housings



Connector & Housing Type: **Housing for Female Terminals**

Mating Tab Width: **1.2 mm [.047 in]**

Connector System: **Wire-to-Wire**

Number of Positions: **2**

Centerline (Pitch): **4 mm [.157 in]**

Features

Product Type Features

Connector Shape	Rectangular
Connector & Housing Type	Housing for Female Terminals
Connector System	Wire-to-Wire
Sealable	Yes
Hybrid Connector	No
Primary Locking Feature	On the Terminal
Connector & Contact Terminates To	Wire & Cable

Configuration Features

Number of Positions	2
Number of Rows	1

Electrical Characteristics

Operating Voltage	12 VDC
Nominal Voltage Architecture	12 V

Body Features

Cable Exit Angle	180°
Primary Product Color	Natural
Connector & Keying Code	B

Contact Features



Contact Size	1.2mm
Contact Type	Receptacle
Mating Tab Width	1.2 mm[.047 in]
Contact Current Rating (Max)	25 A

Mechanical Attachment

Terminal Position Assurance	Yes
Strain Relief	Without
Mating Alignment Type	Keyed
Mating Alignment	With
Connector Mounting Type	Cable Mount (Free-Hanging)

Housing Features

Housing Material	PA GF
Centerline (Pitch)	4 mm[.157 in]

Dimensions

Connector Height	14.8 mm[.583 in]
Product Width	26.5 mm[1.043 in]
Product Length	15 mm[.591 in]

Usage Conditions

Operating Temperature (Max)	70 °C, 75 °C, 80 °C, 85 °C, 90 °C, 100 °C, 105 °C, 110 °C, 120 °C, 125 °C, 130 °C[158 °F][167 °F][176 °F][185 °F][194 °F][212 °F][221 °F][230 °F][248 °F][257 °F][266 °F]
Operating Temperature Range	-40 – 130 °C[-40 – 266 °F]

Operation/Application

Circuit Application	Power
---------------------	-------

Industry Standards

Degree of Protection	IP6K9K
----------------------	--------

Packaging Features

Packaging Quantity	2000
Packaging Method	Box

Other

Serviceable	Yes
Connector Position Assurance Capable	No



Product Compliance

[For compliance documentation, visit the product page on TE.com>](#)

EU RoHS Directive 2011/65/EU	Compliant
EU ELV Directive 2000/53/EC	Compliant
China RoHS 2 Directive MIIT Order No 32, 2016	No Restricted Materials Above Threshold
EU REACH Regulation (EC) No. 1907/2006	Current ECHA Candidate List: JUNE 2023 (235) Candidate List Declared Against: JUNE 2023 (235) Does not contain REACH SVHC
Halogen Content	Low Halogen - Br, Cl, F, I < 900 ppm per homogenous material. Also BFR/CFR/PVC Free
Solder Process Capability	Not applicable for solder process capability

Product Compliance Disclaimer

This information is provided based on reasonable inquiry of our suppliers and represents our current actual knowledge based on the information they provided. This information is subject to change. The part numbers that TE has identified as EU RoHS compliant have a maximum concentration of 0.1% by weight in homogenous materials for lead, hexavalent chromium, mercury, PBB, PBDE, DBP, BBP, DEHP, DIBP, and 0.01% for cadmium, or qualify for an exemption to these limits as defined in the Annexes of Directive 2011/65/EU (RoHS2). Finished electrical and electronic equipment products will be CE marked as required by Directive 2011/65/EU. Components may not be CE marked. Additionally, the part numbers that TE has identified as EU ELV compliant have a maximum concentration of 0.1% by weight in homogenous materials for lead, hexavalent chromium, and mercury, and 0.01% for cadmium, or qualify for an exemption to these limits as defined in the Annexes of Directive 2000/53/EC (ELV). Regarding the REACH Regulation, the information TE provides on SVHC in articles for this part number is based on the latest European Chemicals Agency (ECHA) 'Guidance on requirements for substances in articles' posted at this URL: <https://echa.europa.eu/guidance-documents/guidance-on-reach>

Compatible Parts

 <p>TE Part # CAT-M4595-T273 MCON Receptacle and Tab</p>	 <p>TE Part # 1-1414995-0 V23230D2001B200</p>	 <p>TE Part # 2-1703498-3 2POS, MCON 1.2 LL TAB SEALED COD B</p>	 <p>TE Part # 2-1703498-1 2POS, MCON 1.2 LL TAB SEALED COD B</p>
---	--	---	---



TE Part # 2-1703498-2
2POS, MCON 1.2 LL TAB SEALED
COD B



TE Part # 2-1703498-4
2POS, MCON 1.2 LL TAB SEALED
COD B



TE Part # 5-1415009-7
V23230D1001B200



TE Part # 2-2236952-5
2POS, MCON 1.2 LL TAB SEALED
COD B

Also in the Series | MCON Interconnection System

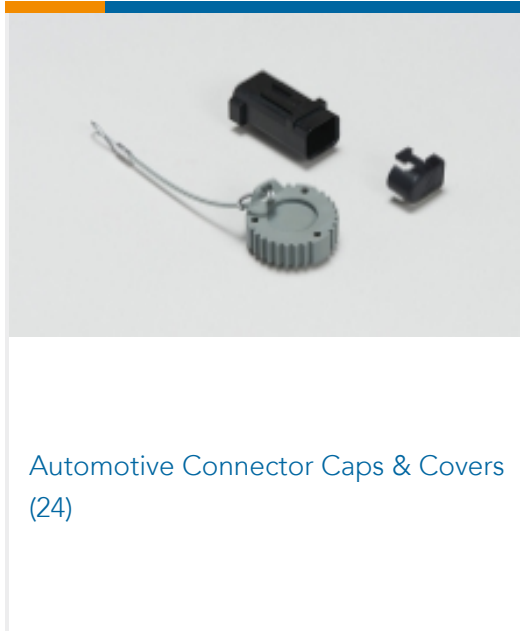

Automotive Connector Caps & Covers
(24)



Automotive Connector Locks &
Position Assurance(11)

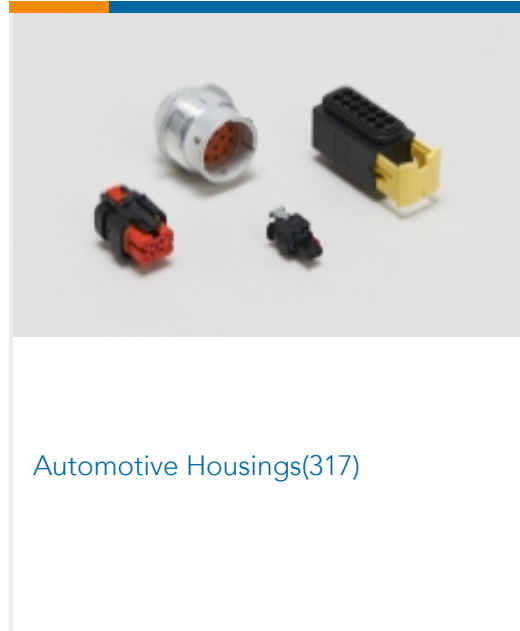

Automotive Housings(317)

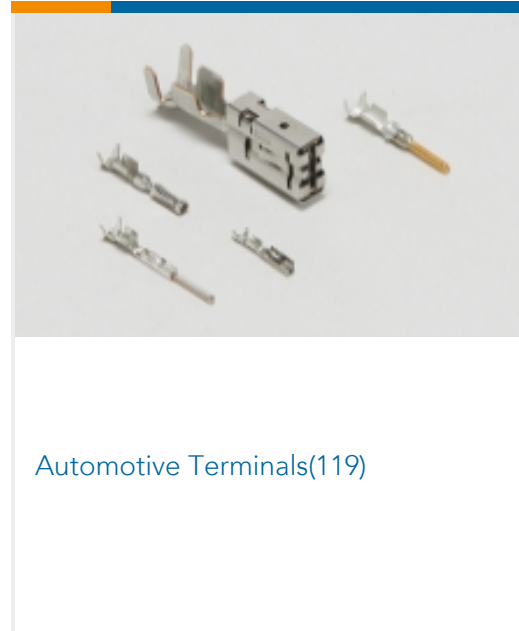

Automotive Terminals(119)

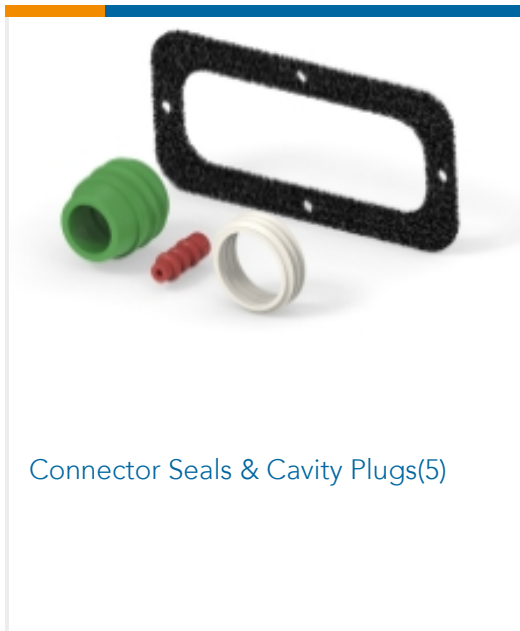

Connector Seals & Cavity Plugs(5)

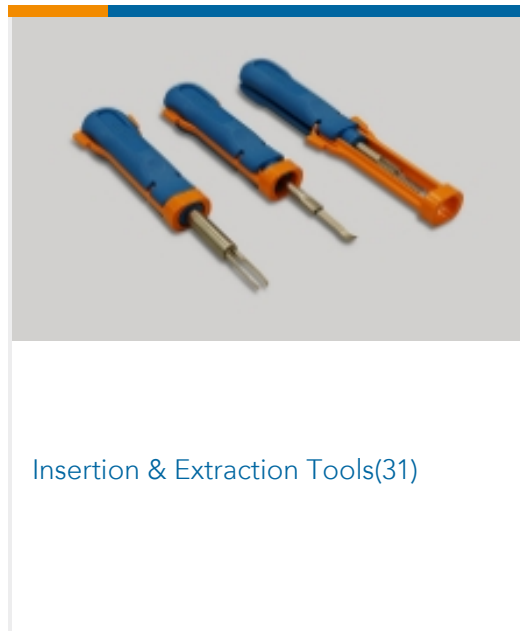

Insertion & Extraction Tools(31)

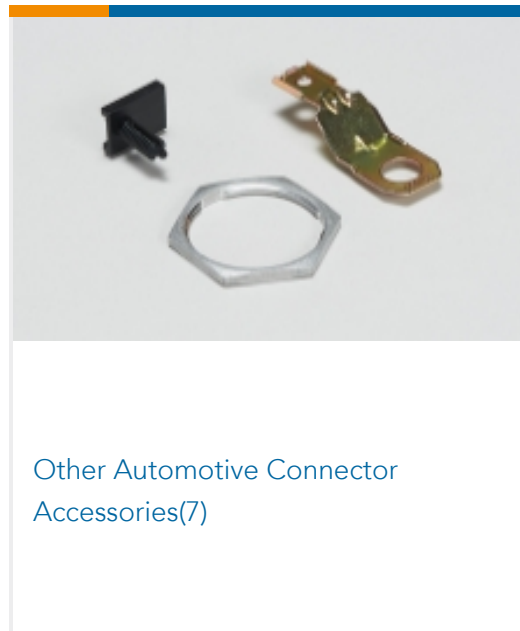

Other Automotive Connector
Accessories(7)



PCB Headers & Receptacles(1)

Customers Also Bought

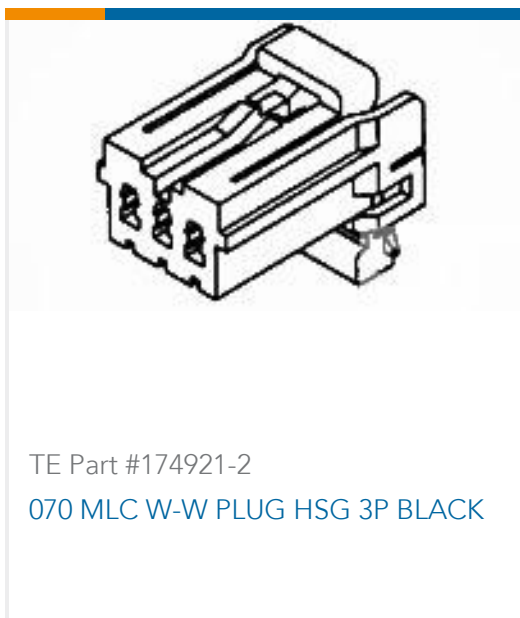

TE Part #174921-2
070 MLC W-W PLUG HSG 3P BLACK



TE Part #1-1670916-1
2POS, MCON 1.2 LL REC SEALED

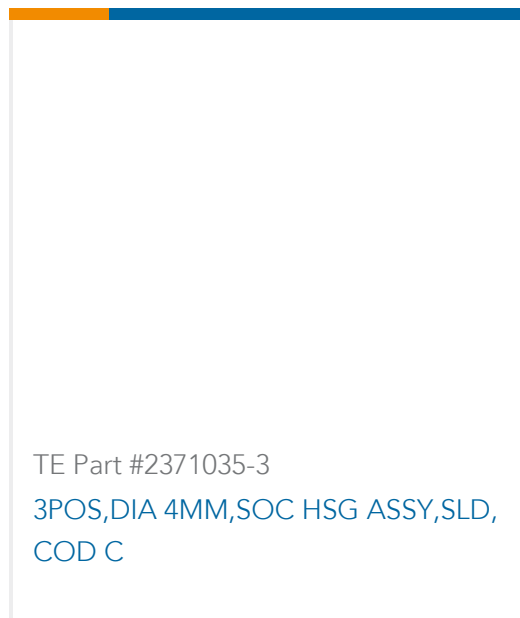

TE Part #2371035-3
3POS,DIA 4MM,SOC HSG ASSY,SLD,
COD C



TE Part #2371243-1
CU ALLOY, OUTER FERRULE, ICT CVE
COD C



TE Part #2822636-1
EJ-2 DBL LOCK PLUG 4P ASSY A



TE Part #1544978-1
RECEPT HSG ASSY, 8MM NG1+, 2W,
SEALED



TE Part #2327728-2
COVER2, 6P OBDII SEALED
CONNECTOR



TE Part #9-2177815-3
PIN DIA 3.6, L/N, ASSY

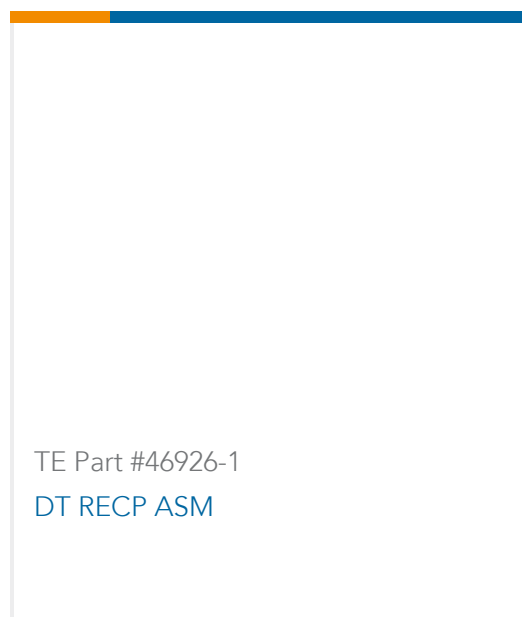

Documents

Product Drawings

[2POS, MCON 1.2 LL REC SEALED](#)

English

CAD Files

Customer View Model

[ENG_CVM_CVM_2-1670916-1_E.3d_igs.zip](#)

English

Customer View Model

[ENG_CVM_CVM_2-1670916-1_E.2d_dxf.zip](#)

English

[3D PDF](#)

3D

Customer View Model

[ENG_CVM_CVM_2-1670916-1_E.3d_stp.zip](#)

English

By downloading the CAD file I accept and agree to the [Terms and Conditions](#) of use.

Datasheets & Catalog Pages

[MCON Interconnection System](#)

English

Product Specifications

[Application Specification](#)

English

Product Environmental Compliance

[Product Compliance](#)

English

[Product Compliance](#)

English