

S10F1C-P02MJG0-2500
series_f, type_s1

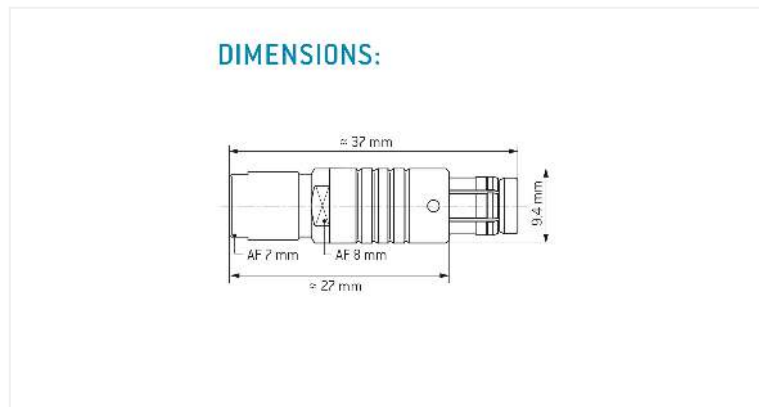

General information

Part number	S10F1C-P02MJG0-2500
Termination	solder
Size	0
Locking principle	push
Coding	1_halfshell
Cable Diameter	cable_mini_25
Cable outlet	standard

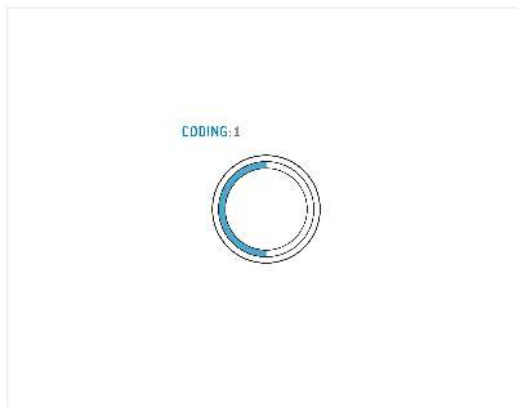

Contact insert description

Number of contacts	2
Contact type	pins
Contact diameter	09mm
Insulator material	peek
Wire cross section	22_awg
Termination	solder
Termination diameter	085mm

reverse_gender_on_request

Technical information

Max. creepage and air clearance distance	10_mm	08_mm
Nominal current single contact	075_a	iec_60512_5_2
Nominal current insert	7,5 A	vde_0298_4
Test voltage	15_kv_ac	sae_13441

safety_text

Mechanical and environmental data

Degree of protection*	ip50
-----------------------	------

Operating temperature	40_120_c
-----------------------	----------

Mating cycles	5000
---------------	------

mated_unmated

Material and surface treatments

Housing	m_chrome
---------	----------

Contact	cu_alloy_gold
---------	---------------

safety_text_2

ul_text

illustrative_text