

63854-1 ✓ ACTIVE

Positive Lock | Mark III, Positive Lock 250

TE Internal #: 63854-1

Quick Disconnects, Receptacle, 18 – 14 AWG Wire Size, .82 – 2.08 mm² Wire Size, Mating Tab Width 6.35 mm [.25 in], Straight, Brass, Positive Lock 250

[View on TE.com >](#)



Terminals & Splices > Quick Disconnects



Quick Disconnect Terminal Type: **Receptacle**

Wire Size: **.82 – 2.08 mm²**

Mating Tab Width: **6.35 mm [.25 in]**

Mating Tab Thickness: **.81 mm [.032 in]**

Features

Product Type Features

Insertion Force	Low
-----------------	-----

Configuration Features

Connection Capacity	Single
---------------------	--------

Compatible With Wire & Cable Type	Discrete Wire
-----------------------------------	---------------

Contact Features

Quick Disconnect Terminal Type	Receptacle
--------------------------------	------------

Mating Tab Width	6.35 mm [.25 in]
------------------	------------------

Mating Tab Thickness	.81 mm [.032 in]
----------------------	------------------

Terminal Orientation	Straight
----------------------	----------

Contact Base Material	Brass
-----------------------	-------

Terminal Plating Material	Unplated
---------------------------	----------

Crimp Type	F-Crimp
------------	---------

Barrel Type	Open
-------------	------

Termination Features



Product Terminates To	Wire & Cable
-----------------------	--------------

Mechanical Attachment

Wire Insulation Support	With
Mating Retention Type	Dimple

Dimensions

Terminal Material Thickness	.41 mm[.016 in]
Product Length	19.58 mm[.771 in]
Compatible Insulation Diameter Range	2.29 – 3.94 mm[.09 – .155 in]
Wire Size	.82 – 2.08 mm ²

Usage Conditions

Insulation Option	Uninsulated
Operating Temperature Range	-40 – 110 °C[-40 – 230 °F]

Industry Standards

Agency/Standard	UL
-----------------	----

Packaging Features

Packaging Quantity	10000
Packaging Method	Strip/Reel

Product Compliance

[For compliance documentation, visit the product page on TE.com>](#)

EU RoHS Directive 2011/65/EU	Compliant
EU ELV Directive 2000/53/EC	Compliant
China RoHS 2 Directive MIIT Order No 32, 2016	No Restricted Materials Above Threshold
EU REACH Regulation (EC) No. 1907/2006	Current ECHA Candidate List: JUNE 2023 (235) Candidate List Declared Against: JUNE 2023 (235) Does not contain REACH SVHC
Halogen Content	Low Halogen - Br, Cl, F, I < 900 ppm per homogenous material. Also BFR/CFR/PVC Free
Solder Process Capability	Not applicable for solder process capability

Product Compliance Disclaimer

This information is provided based on reasonable inquiry of our suppliers and represents our current actual knowledge based on the information they provided. This information is subject to change. The part numbers that TE has identified as EU RoHS compliant have a maximum concentration of 0.1% by weight in homogenous materials for lead, hexavalent chromium, mercury, PBB, PBDE, DBP, BBP, DEHP, DIBP, and 0.01% for cadmium, or qualify for an exemption to these limits as defined in the Annexes of Directive 2011/65/EU (RoHS2). Finished electrical and electronic equipment products will be CE marked as required by Directive 2011/65/EU. Components may not be CE marked. Additionally, the part numbers that TE has identified as EU ELV compliant have a maximum concentration of 0.1% by weight in homogenous materials for lead, hexavalent chromium, and mercury, and 0.01% for cadmium, or qualify for an exemption to these limits as defined in the Annexes of Directive 2000/53/EC (ELV). Regarding the REACH Regulation, the information TE provides on SVHC in articles for this part number is based on the latest European Chemicals Agency (ECHA) 'Guidance on requirements for substances in articles' posted at this URL: <https://echa.europa.eu/guidance-documents/guidance-on-reach>

Compatible Parts





Also in the Series | **Mark III**

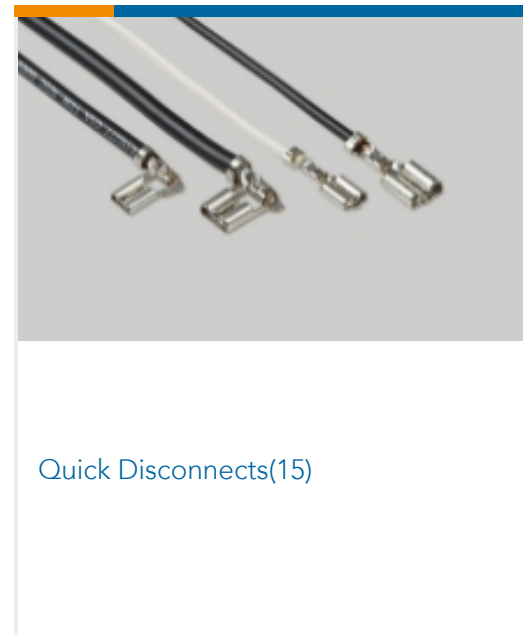
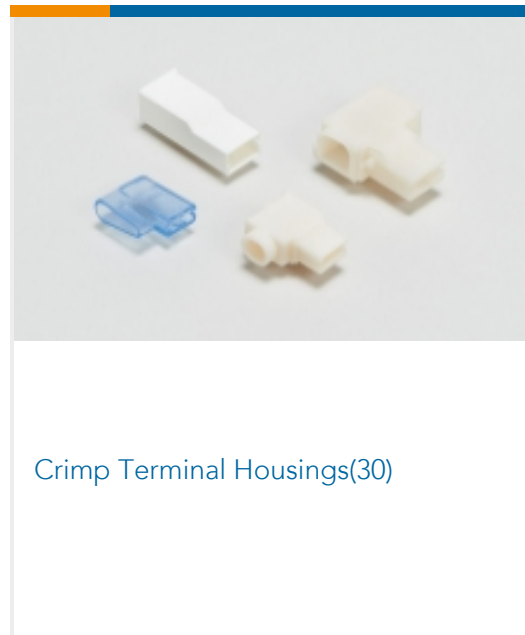

Also in the Series | **Positive Lock 250**

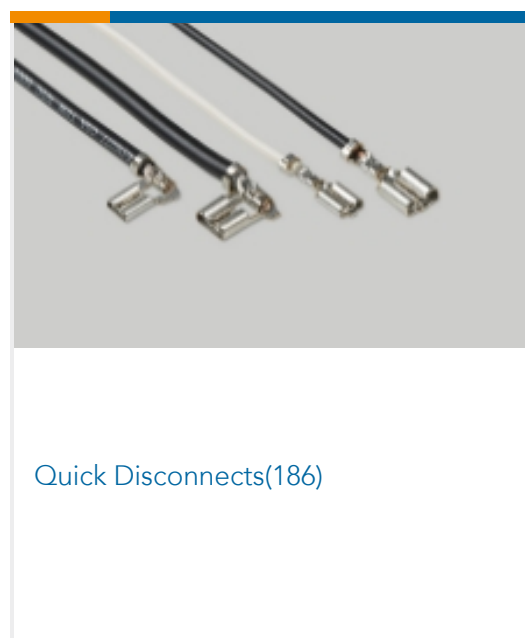
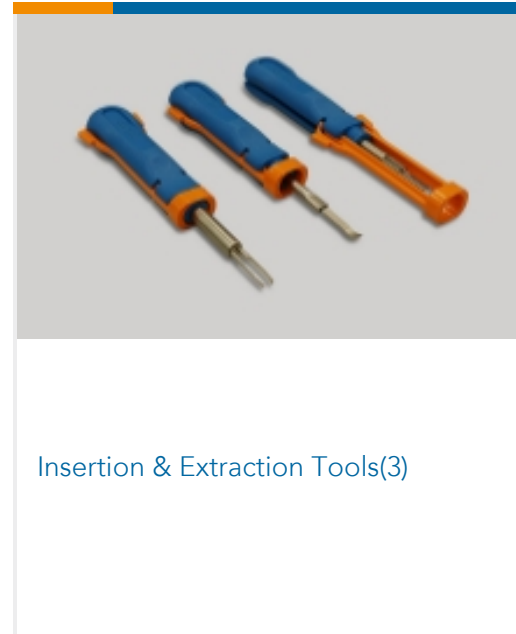
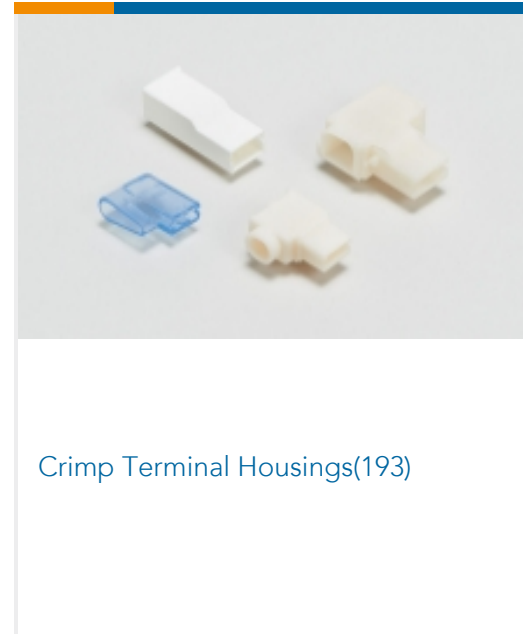
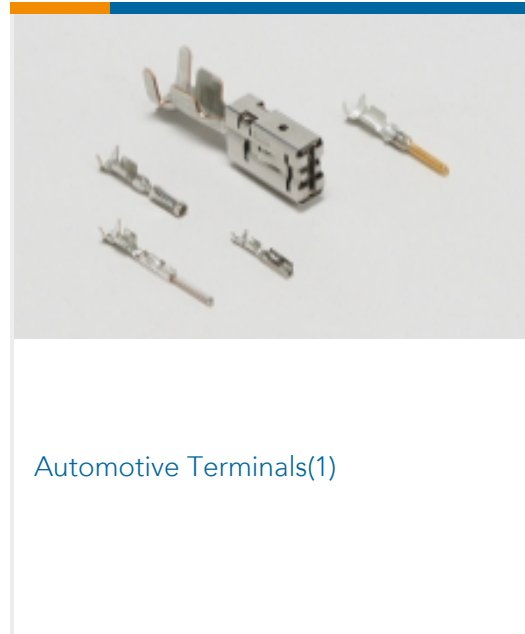

Customers Also Bought



TE Part #521367-2
ULTRA-POD 250 ASSY REC 18-14
AWG TPBR



TE Part #4-1630012-1
HSC150 125R 5%



TE Part #521780-1
250 HSG. PL MKIII REC. 7.11mm 5P
NAT

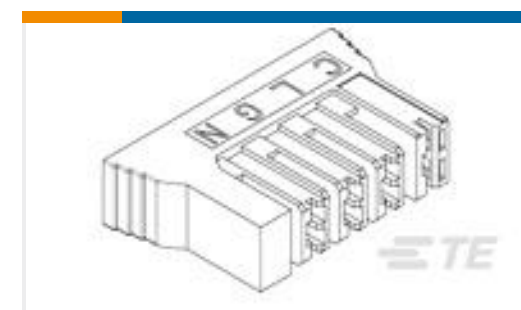

TE Part #521781-1
250 HSG. PL MKIII REC. 6.81mm 4P
NAT



TE Part #350538-1
UMNL PIN 20-14 .0126 PTPBR



TE Part #60394-1
RING TERMINAL 20-16 AWG BR



TE Part #60196-1
187 FASTON REC 20-16 AWG BR



TE Part #350537-1
UMNL SOK 20-14 .0126 PTPBR



TE Part #1217113-2
187 PL MKIII REC. 22-18AWG TPBR

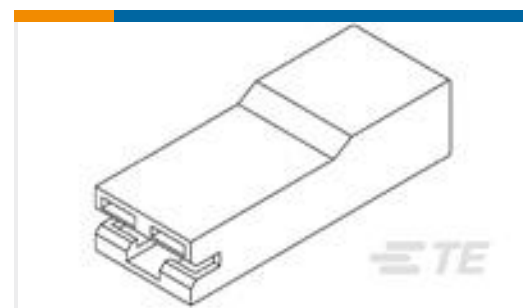

TE Part #1-521120-3
HSG RECPT POSILOK MK III 250 V0

Documents

Product Drawings

[250 PL MKIII REC. 18-14AWG BR](#)

English

CAD Files

[3D PDF](#)

3D

Customer View Model

[ENG_CVM_CVM_63854-1_V.2d_dxf.zip](#)

English

Customer View Model

[ENG_CVM_CVM_63854-1_V.3d_igs.zip](#)

English

Customer View Model

[ENG_CVM_CVM_63854-1_V.3d_stp.zip](#)

English

By downloading the CAD file I accept and agree to the [Terms and Conditions](#) of use.

Datasheets & Catalog Pages



[1654742_HOUSEHOLD_APPLIANCES_RAST5](#)

English

[Positive Lock Receptacles](#)

English

[Product Specifications](#)

[Engineering Report](#)

English

[Product Environmental Compliance](#)

[MD_63854-1_01022018837_dmtec](#)

English

[MD_63854-1_01022018837_dmtec](#)

English