

QT-Brightek PLCC Series

3528 PLCC2 IR LED

Part No.: QBLP670-IR1

Product: QBLP670-IR1	Date: May 01, 2015	Page 1 of 9
	Version# 1.0	

Table of Contents:

Introduction	3
Electrical / Optical Characteristic (Ta=25 °C)	4
Absolute Maximum Rating	4
Characteristic Curves.....	5
Solder Profile & Footprint.....	6
Packing	7
Labeling	8
Ordering Information	8
Revision History	9
Disclaimer	9

Introduction

Feature:

- Water clear lens
- Package in tape and reel
- AlGaAs technology
- Viewing Angle = 120 deg

Description:

This reflector type PLCC2 IR LED has a height profile of 1.90mm with a clear lens that produces high radiant power with a wide viewing angle.

Application:

- Infrared Sensor
- Optoelectronic Switch
- Smoke detector
- Drive sensor

Certification & Compliance:

- ISO9001
- RoHS Compliant



Dimension:

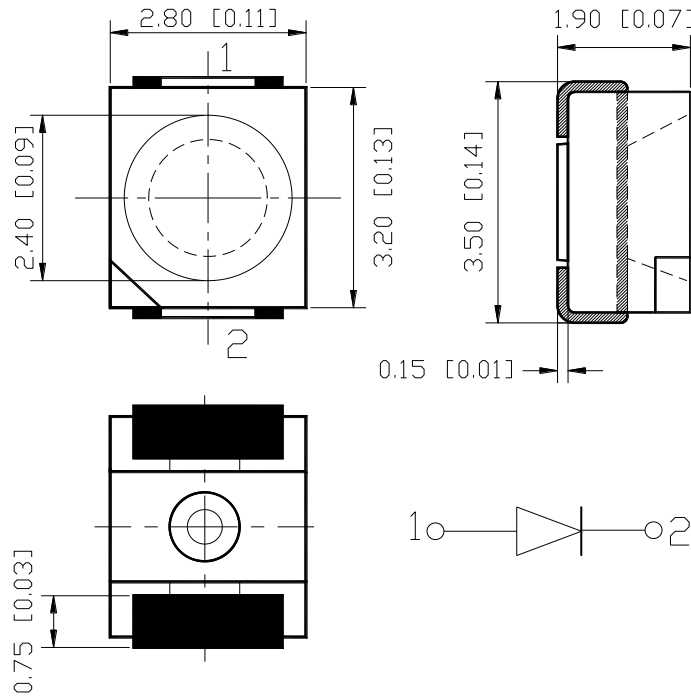

Units: mm / tolerance = +/-0.2mm

Product: QBLP670-IR1	Date: May 01, 2015	Page 3 of 9
	Version# 1.0	

Electrical / Optical Characteristic (Ta=25 °C)

Product	Color	I _F (mA)	V _F (V)		λ _P (nm)			I _e (mW/sr)		
			Typ.	Max.	Min.	Typ.	Max.	Min.	Typ.	Max.
QBLP670-IR1	Infrared	20	1.2	1.6	930	940	950	0.2	0.5	1.6

Absolute Maximum Rating

Material	P _d (mW)	I _F (mA)	I _{FP} (A)*	V _R (V)	T _{OP} (°C)	T _{ST} (°C)	T _{SOL} (°C)**
AlGaAs	80	50	1	5	-40 ~ +80	-40 ~ +85	260

*Duty cycle=1%, Pulse width 100us

**IR Reflow for no more than 10 sec @ 260 °C

Characteristic Curves

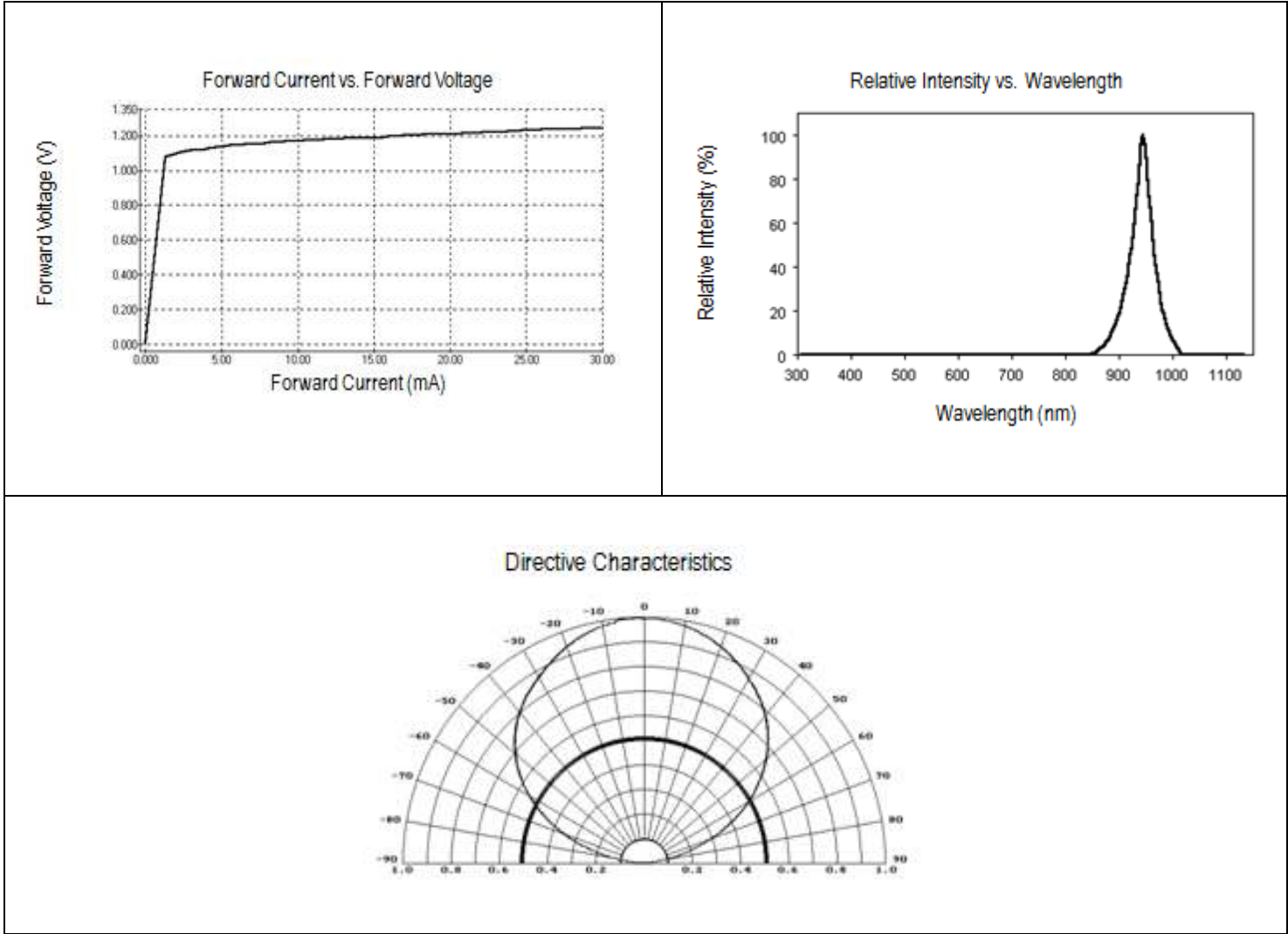

Solder Profile & Footprint

- Recommended tin solder specifications: melting temperature in the range of 178~192 °C
- The recommended reflow soldering profile is as follows (temperatures indicated are as measured on the surface of the LED resin):

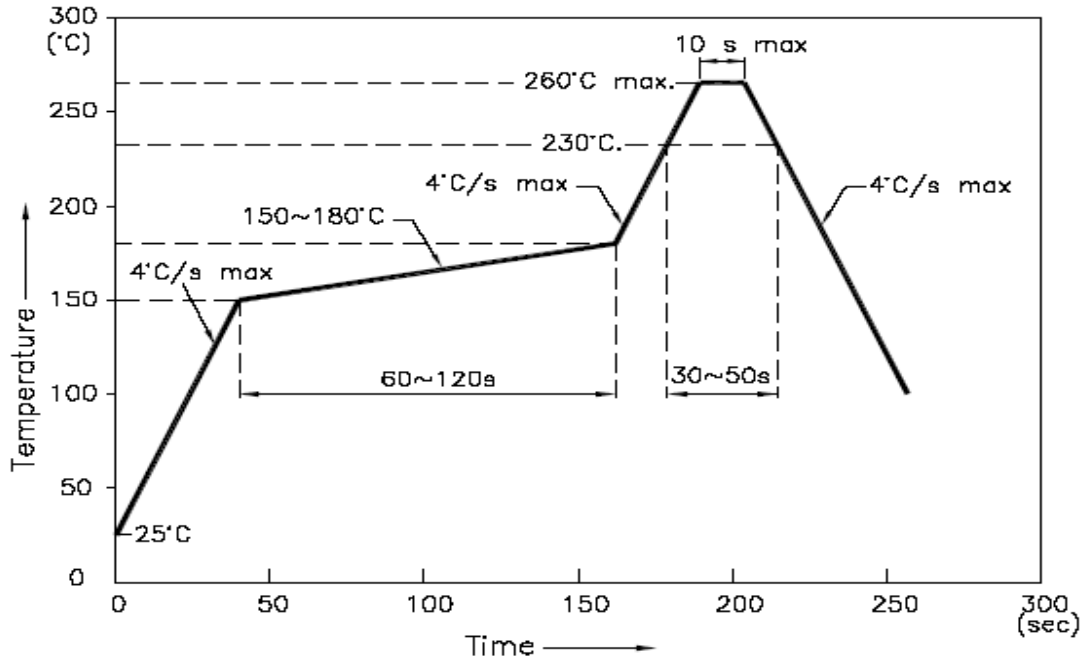

Recommended Pad Layout

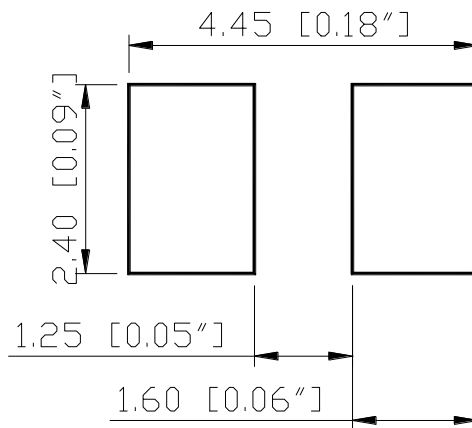

Units: mm

Tolerance: ± 0.2mm

Packing

Reel Dimension:

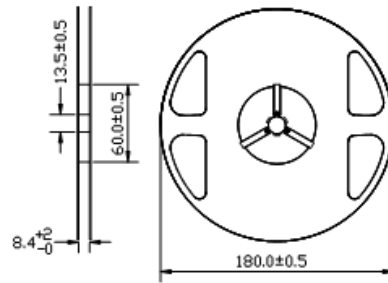

Unit: mm

Tape Dimension:

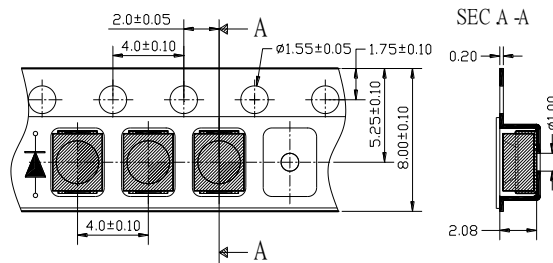

Unit: mm

Arrangement of Tape:

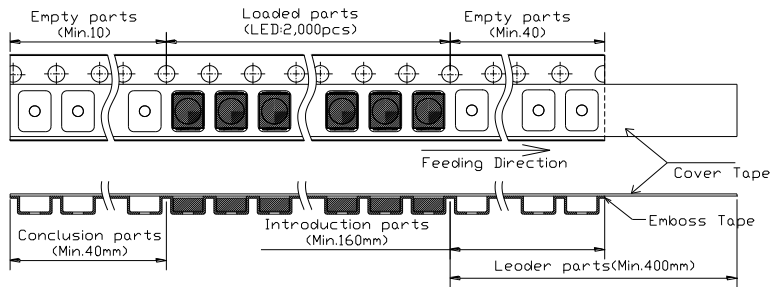

Packaging Specification:

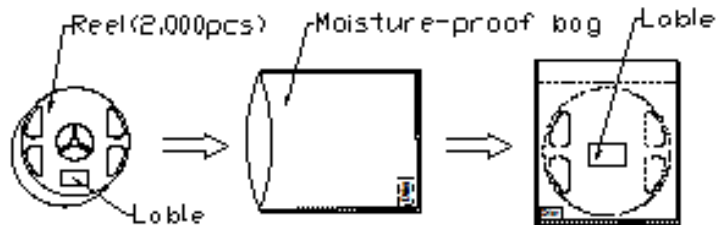

Product: QBLP670-IR1	Date: May 01, 2015	Page 7 of 9
	Version# 1.0	

Labeling

Part No: _____

Customer P/N: _____

Item: _____

Q'ty: _____

Vf: _____

Iv: _____

WI: _____

Date: _____

Made in China**Ordering Information**

Part #	Orderable Part #	Spec Range	Quantity per reel
QBLP670-IR1	QBLP670-IR1	I _e =0.5mW/sr typ. @ I _F =20mA / λ _p =940nm typ.	2,000 units

Product: QBLP670-IR1	Date: May 01, 2015	Page 8 of 9
	Version# 1.0	

Revision History

Description:	Revision #	Revision Date
New Release of QBLP670-IR1	V1.0	05/01/2015

Disclaimer

QT-BRIGHTTEK reserves the right to make changes without further notice to any products herein to improve reliability, function or design. QT-BRIGHTTEK does not assume any liability arising out of the application or use of any product or circuit described herein; neither does it convey any license under its patent rights, nor the rights of others.

Life Support Policy

QT-BRIGHTTEK's products are not authorized for use as critical components in life support devices or systems without the express written approval of QT-BRIGHTTEK. As used herein:

1. Life support devices or systems are devices or systems which, (a) are intended for surgical implant into the body, or (b) support or sustain life, and (c) whose failure to perform when properly used in accordance with instructions for use provided in the labeling, can be reasonably expected to result in a significant injury of the user.
2. A critical component in any component of a life support device or system whose failure to perform can be reasonably expected to cause the failure of the life support device or system, or to affect its safety or effectiveness.

Product: QBLP670-IR1	Date: May 01, 2015	Page 9 of 9
	Version# 1.0	