

MOSFET

Metal Oxide Semiconductor Field Effect Transistor

CoolMOS™ CFD2 650V

650V CoolMOS™ CFD2 Power Transistor
IPD65R1K4CFD

Data Sheet

Rev. 2.2
Final

Industrial & Multimarket

1 Description

CoolMOS™ is a revolutionary technology for high voltage power MOSFETs, designed according to the superjunction (SJ) principle and pioneered by Infineon Technologies. 650V CoolMOS™ CFD2 series combines the experience of the leading SJ MOSFET supplier with high class innovation. The resulting devices provide all benefits of a fast switching SJ MOSFET while offering an extremely fast and robust body diode. This combination of extremely low switching, commutation and conduction losses together with highest robustness make especially resonant switching applications more reliable, more efficient, lighter and cooler.

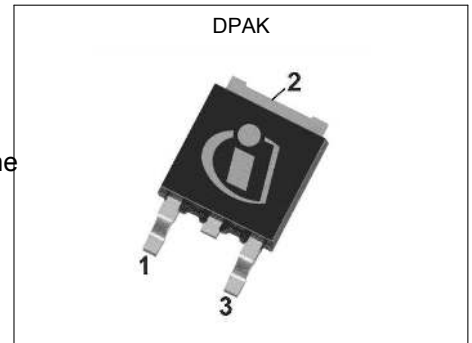

Features

- Ultra-fast body diode
- Easy to use/drive
- Very high commutation ruggedness
- Pb-free plating, available in Halogen free mold compound^{a)}
- Extremely low losses due to very low FOM $R_{ds(on)} \cdot Q_g$ and E_{oss}
- Fully qualified according to JEDEC for Industrial Applications

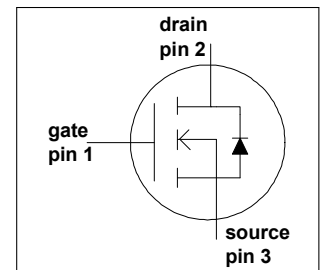

Applications

650V CoolMOS™ CFD2 is especially suitable for resonant switching PWM stages for e.g. PC Silverbox, LCD TV, Lighting, Server, Telecom.



Table 1 Key Performance Parameters

Parameter	Value	Unit
$V_{DS} @ T_{j \max}$	700	V
$R_{DS(on), \max}$	1.4	Ω
Q_g, typ	10	nC
I_D, pulse	8.2	A
$E_{oss} @ 400V$	1	μJ
Body diode di/dt	900	A/ μs
Q_{rr}	0.1	μC
t_{rr}	50	ns
I_{rrm}	3.2	A



Type / Ordering Code	Package	Marking	Related Links
IPD65R1K4CFD	PG-TO 252	65F61K4	see Appendix A

Table of Contents

Description	2
Table of Contents	3
Maximum ratings	4
Thermal characteristics	5
Electrical characteristics	6
Electrical characteristics diagrams	8
Test Circuits	12
Package Outlines	13
Appendix A	14
Revision History	15
Disclaimer	15

2 Maximum ratings

at $T_j = 25^\circ\text{C}$, unless otherwise specified

Table 2 Maximum ratings

Parameter	Symbol	Values			Unit	Note / Test Condition
		Min.	Typ.	Max.		
Continuous drain current ¹⁾	I_D			2.8	A	$T_C = 25^\circ\text{C}$
				1.8		$T_C = 100^\circ\text{C}$
Pulsed drain current ²⁾	$I_{D,pulse}$			8.2	A	$T_C = 25^\circ\text{C}$
Avalanche energy, single pulse	E_{AS}			26	mJ	$I_D = 0.6\text{A}$, $V_{DD} = 50\text{V}$ (see table 18)
Avalanche energy, repetitive	E_{AR}			0.10	mJ	$I_D = 0.6\text{A}$, $V_{DD} = 50\text{V}$
Avalanche current, repetitive	I_{AR}			0.6	A	
MOSFET dv/dt ruggedness	dv/dt			50	V/ns	$V_{DS} = 0 \dots 400\text{V}$
Gate source voltage	V_{GS}	-20		20	V	static
		-30		30		AC ($f > 1\text{ Hz}$)
Operating and storage temperature	T_j, T_{stg}	-55		150	$^\circ\text{C}$	
Continuous diode forward current	I_S			2.8	A	$T_C = 25^\circ\text{C}$
Diode pulse current	$I_{S,pulse}$			8.2	A	$T_C = 25^\circ\text{C}$
Reverse diode dv/dt ³⁾	dv/dt			50	V/ns	$V_{DS} = 0 \dots 400\text{V}$, $I_{SD} \leq I_D$, $T_j = 25^\circ\text{C}$ (see table 16)
Maximum diode commutation speed	di _r /dt			900	A/ μs	
Power dissipation	P_{tot}			28.4	W	$T_C = 25^\circ\text{C}$

¹⁾ Limited by $T_{j,max}$. Maximum

²⁾ Pulse width t_p limited by $T_{j,max}$

³⁾ $V_{peak} < V_{(BR)DSS}$, $T_j < T_{j,max}$, identical low and high side switch with same R_g

3 Thermal characteristics

Table 3 Thermal characteristics DPAK

Parameter	Symbol	Values			Unit	Note / Test Condition
		Min.	Typ.	Max.		
Thermal resistance, junction - case	R_{thJC}			4.4	°C/W	
Thermal resistance, junction - ambient ¹⁾	R_{thJA}			62	°C/W	SMD version, device on PCB, minimal footprint
			35			SMD version, device on PCB, 6cm ² cooling area
Soldering temperature, wave- & reflowsoldering allowed	T_{sold}			260	°C	reflow MSL

¹⁾ Device on 40mm*40mm*1.5mm one layer epoxy PCB FR4 with 6cm² copper area (thickness 70µm) for drain connection. PCB is vertical without air stream cooling.

4 Electrical characteristics

at $T_j = 25^\circ\text{C}$, unless otherwise specified

Table 4 Static characteristics

Parameter	Symbol	Values			Unit	Note / Test Condition
		Min.	Typ.	Max.		
Drain-source breakdown voltage	$V_{(BR)DSS}$	650			V	$V_{GS} = 0\text{V}$, $I_D = 1\text{mA}$
Gate threshold voltage	$V_{GS(th)}$	3.5	4	4.5	V	$V_{DS} = V_{GS}$, $I_D = 0.1\text{mA}$
Zero gate voltage drain current	I_{DSS}			1	μA	$V_{DS} = 650\text{V}$, $V_{GS} = 0\text{V}$, $T_j = 25^\circ\text{C}$
			100			$V_{DS} = 650\text{V}$, $V_{GS} = 0\text{V}$, $T_j = 150^\circ\text{C}$
Gate-source leakage current	I_{GSS}			100	nA	$V_{GS} = 20\text{V}$, $V_{DS} = 0\text{V}$
Drain-source on-state resistance	$R_{DS(on)}$		1.260	1.4	Ω	$V_{GS} = 10\text{V}$, $I_D = 1.0\text{A}$, $T_j = 25^\circ\text{C}$
			3.276			$V_{GS} = 10\text{V}$, $I_D = 1\text{A}$, $T_j = 150^\circ\text{C}$
Gate resistance	R_G		9.5		Ω	$f = 1\text{MHz}$, open drain

Table 5 Dynamic characteristics

Parameter	Symbol	Values			Unit	Note / Test Condition
		Min.	Typ.	Max.		
Input capacitance	C_{iss}		262		pF	$V_{GS} = 0\text{V}$, $V_{DS} = 100\text{V}$, $f = 1\text{MHz}$
Output capacitance	C_{oss}		18		pF	
Effective output capacitance, energy related ¹⁾	$C_{o(er)}$		12		pF	$V_{GS} = 0\text{V}$, $V_{DS} = 0 \dots 400\text{V}$
Effective output capacitance, time related ²⁾	$C_{o(tr)}$		49		pF	$I_D = \text{constant}$, $V_{GS} = 0\text{V}$, $V_{DS} = 0 \dots 400\text{V}$
Turn-on delay time	$t_{d(on)}$		8		ns	$V_{DD} = 400\text{V}$, $V_{GS} = 13\text{V}$, $I_D = 1.5\text{A}$, $R_G = 10.2\Omega$ (see table 17)
Rise time	t_r		6		ns	
Turn-off delay time	$t_{d(off)}$		33		ns	
Fall time	t_f		18.2		ns	

Table 6 Gate charge characteristics

Parameter	Symbol	Values			Unit	Note / Test Condition
		Min.	Typ.	Max.		
Gate to source charge	Q_{gs}		1.78		nC	$V_{DD} = 480\text{V}$, $I_D = 1.5\text{A}$, $V_{GS} = 0 \text{ to } 10\text{V}$
Gate to drain charge	Q_{gd}		5.5		nC	
Gate charge total	Q_g		10		nC	
Gate plateau voltage	V_{plateau}		6.4		V	

¹⁾ $C_{o(er)}$ is a fixed capacitance that gives the same stored energy as C_{oss} while V_{DS} is rising from 0 to 400V

²⁾ $C_{o(tr)}$ is a fixed capacitance that gives the same charging time as C_{oss} while V_{DS} is rising from 0 to 400V

Table 7 Reverse diode characteristics

Parameter	Symbol	Values			Unit	Note / Test Condition
		Min.	Typ.	Max.		
Diode forward voltage	V_{SD}		0.9		V	$V_{GS} = 0V, I_F = 1.5A, T_j = 25^\circ C$
Reverse recovery time	t_{rr}		50		ns	$V_R = 400V, I_F = 1.5A,$ $di_F/dt = 100A/\mu s$ (see table 16)
Reverse recovery charge	Q_{rr}		0.1		μC	
Peak reverse recovery current	I_{rrm}		3.2		A	

5 Electrical characteristics diagrams

Table 8

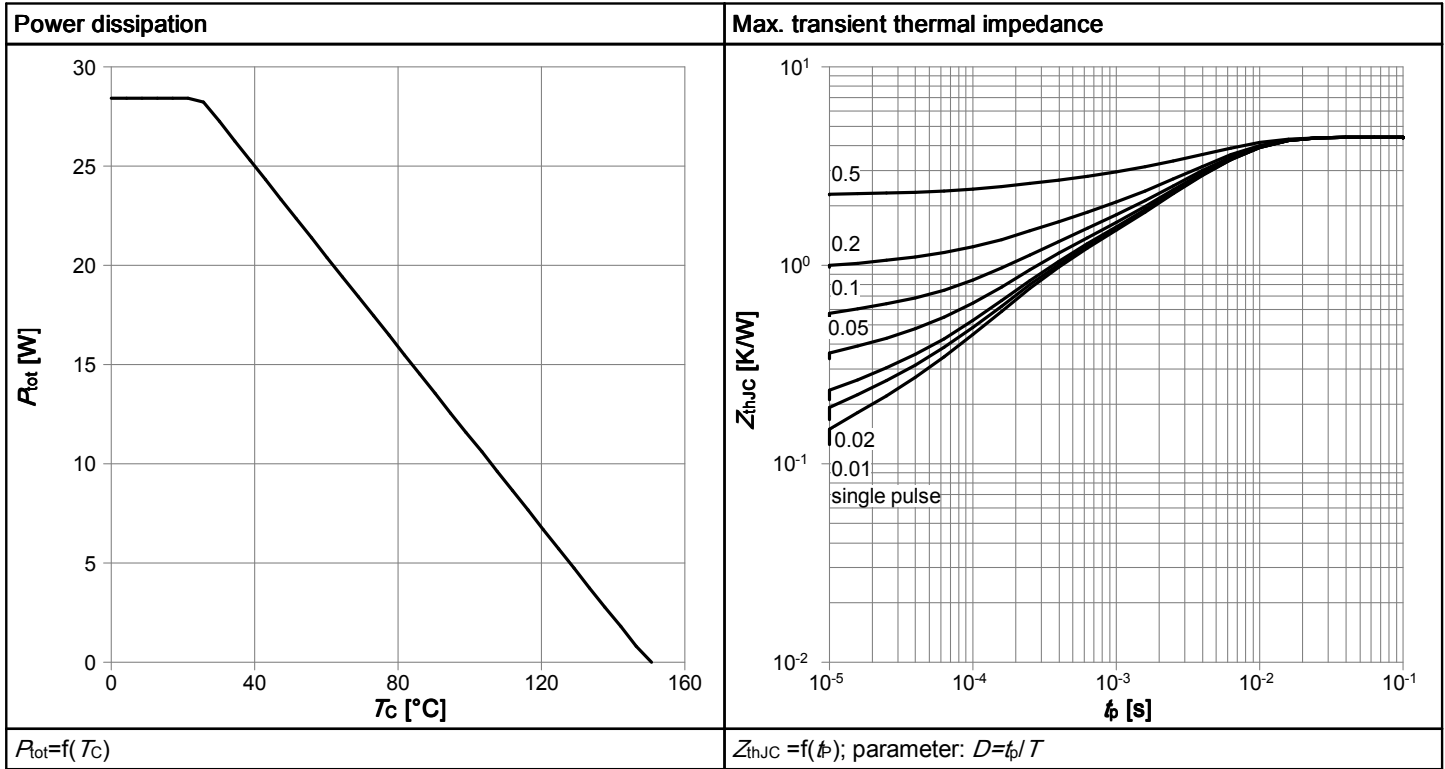

Table 9

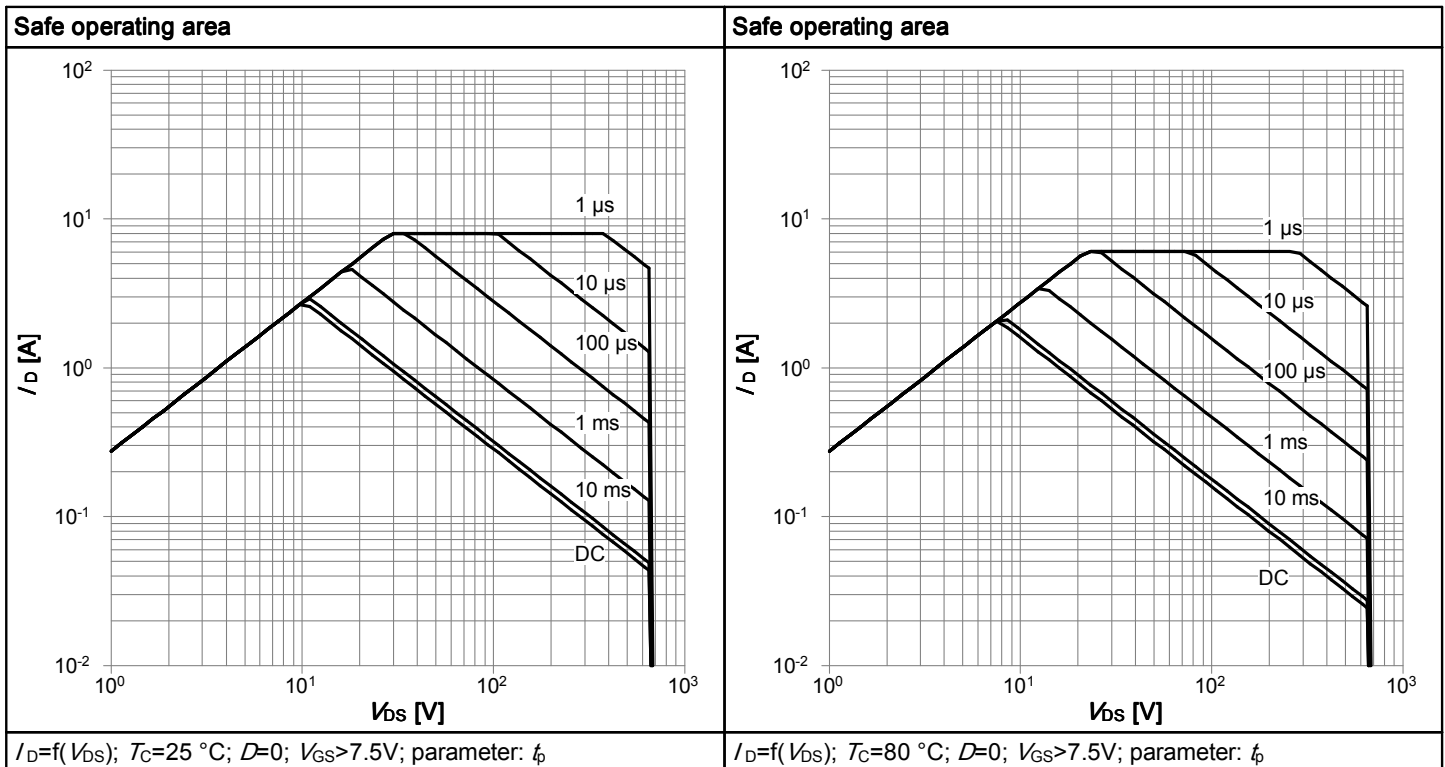

Table 10

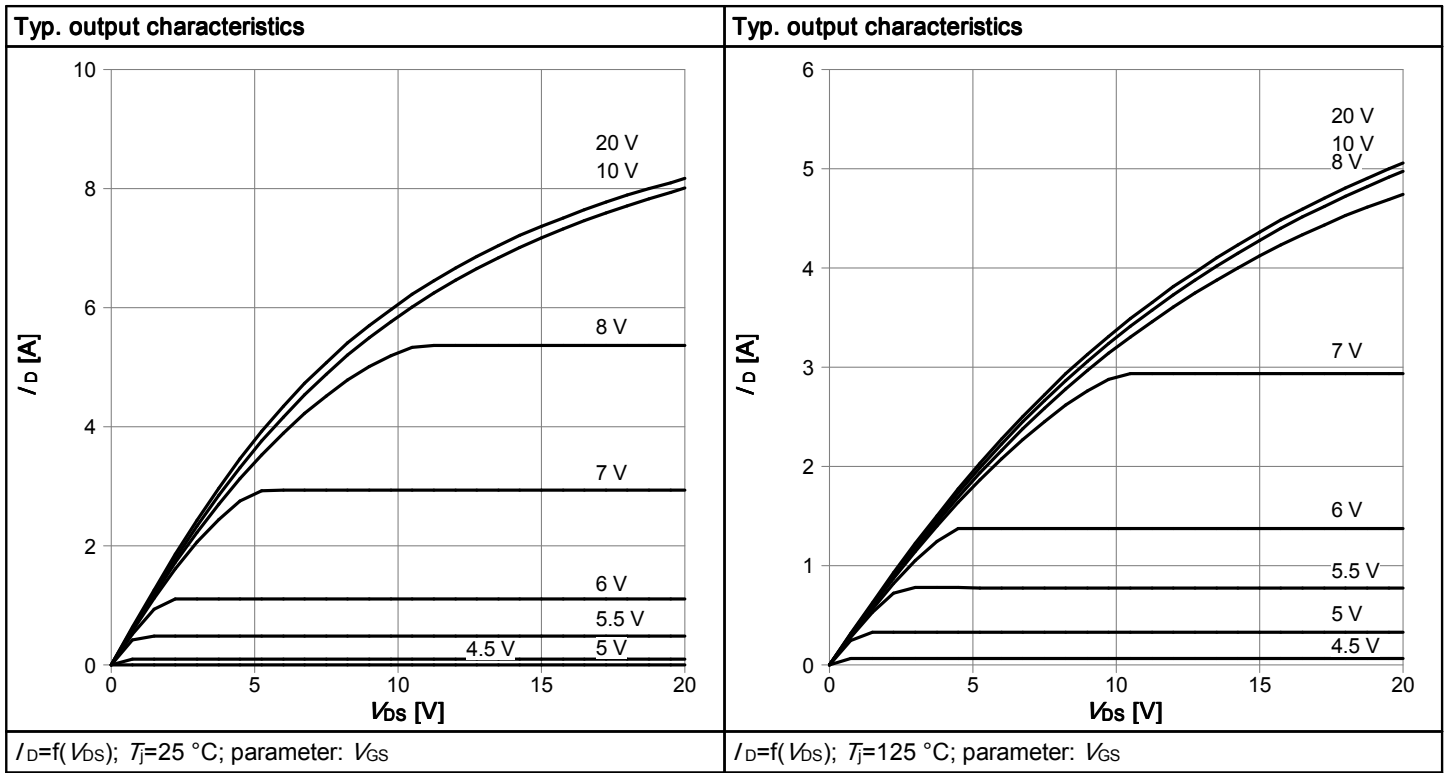

Table 11

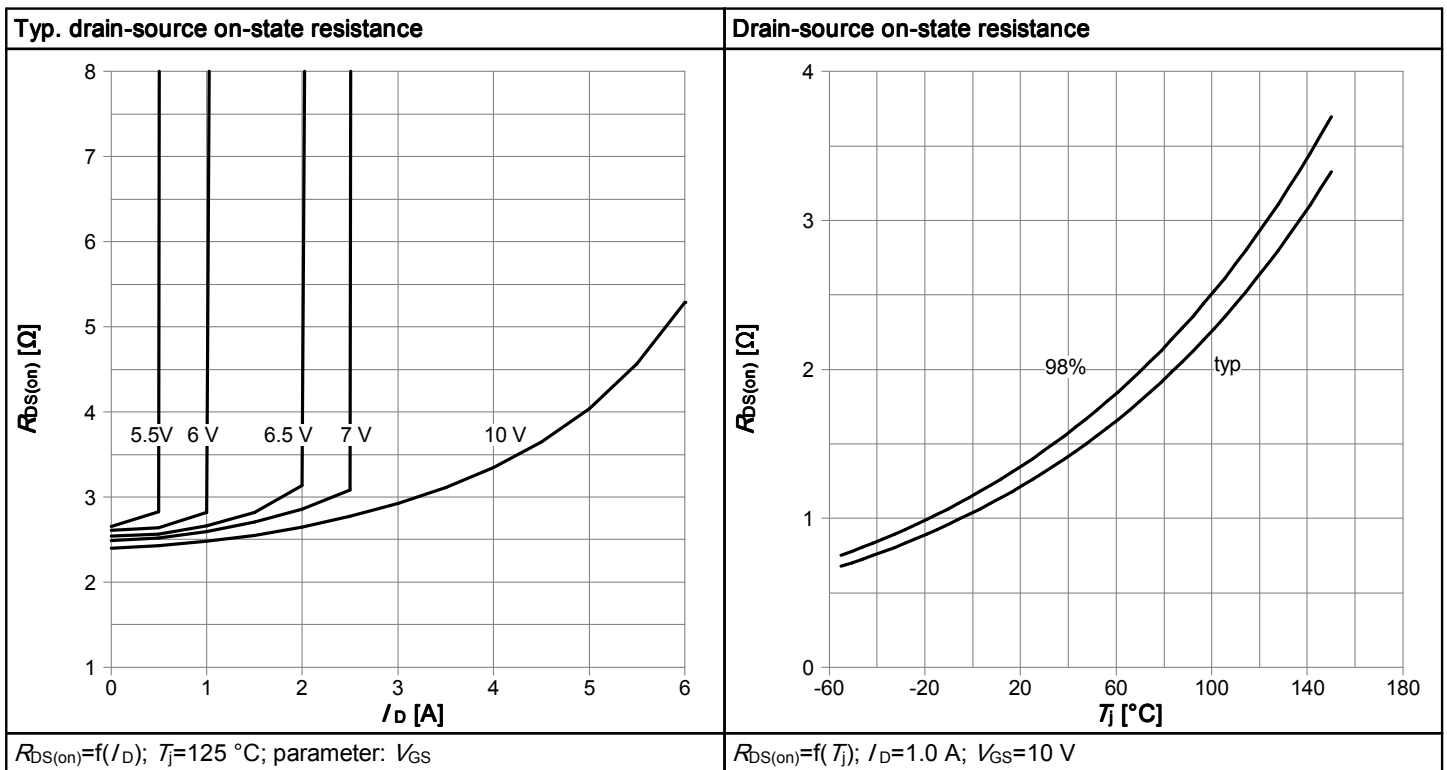

Table 12

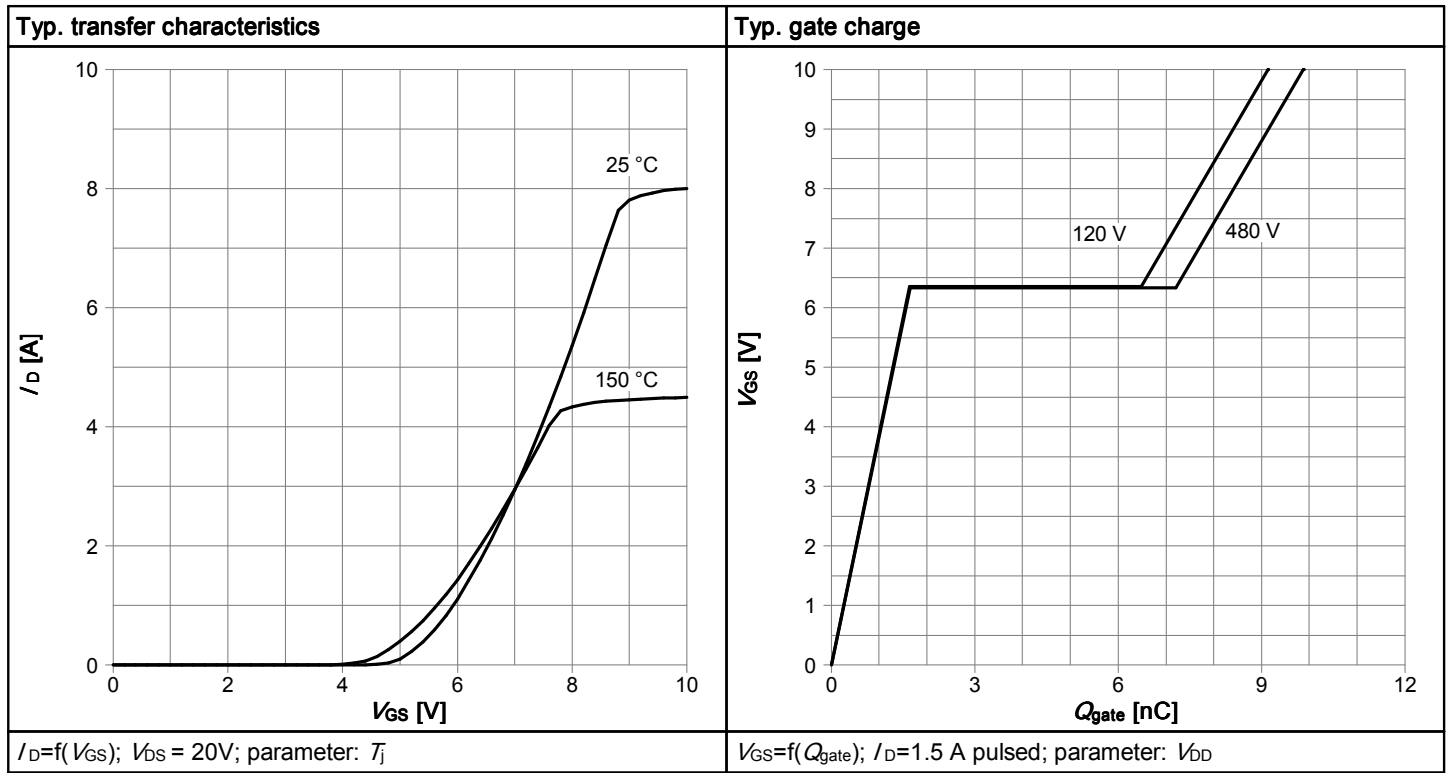

Table 13

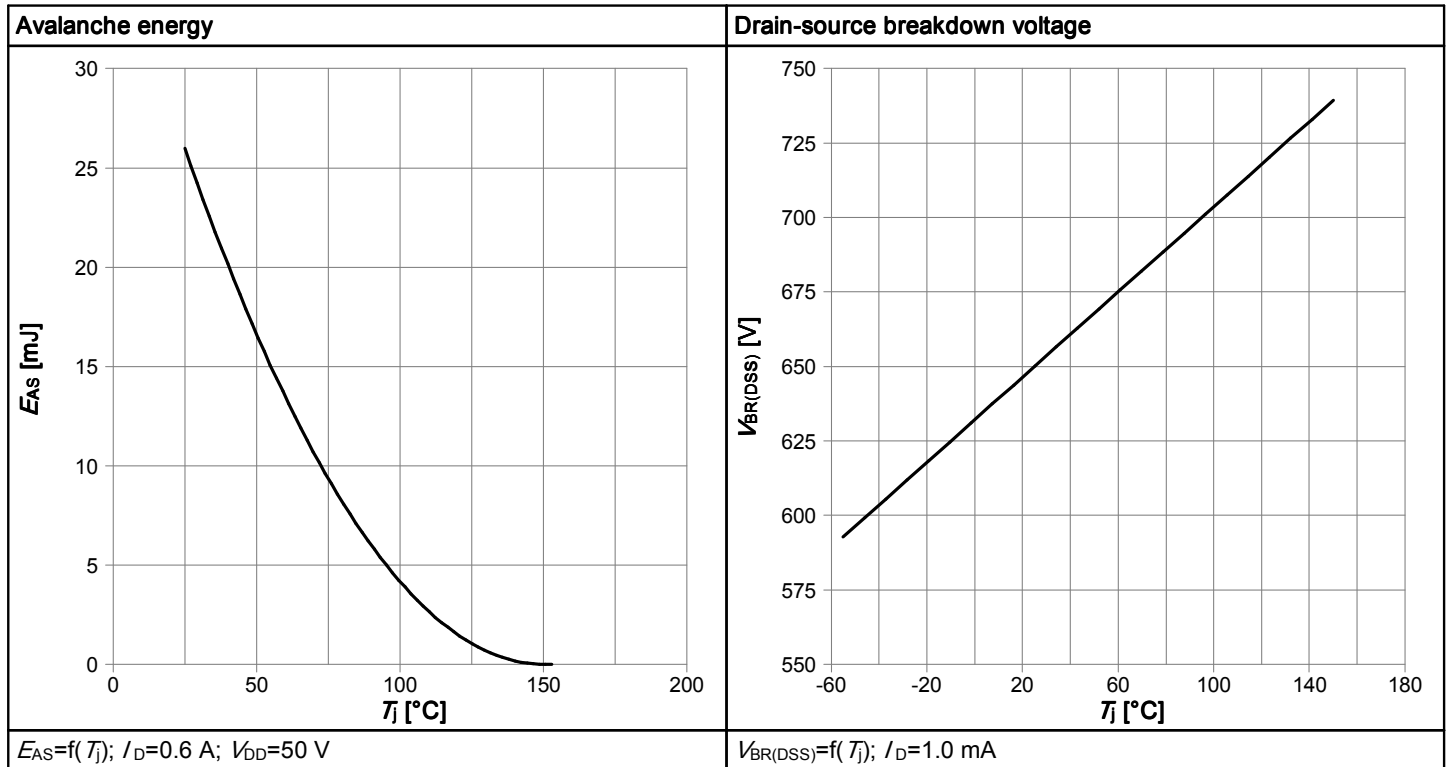

Table 14

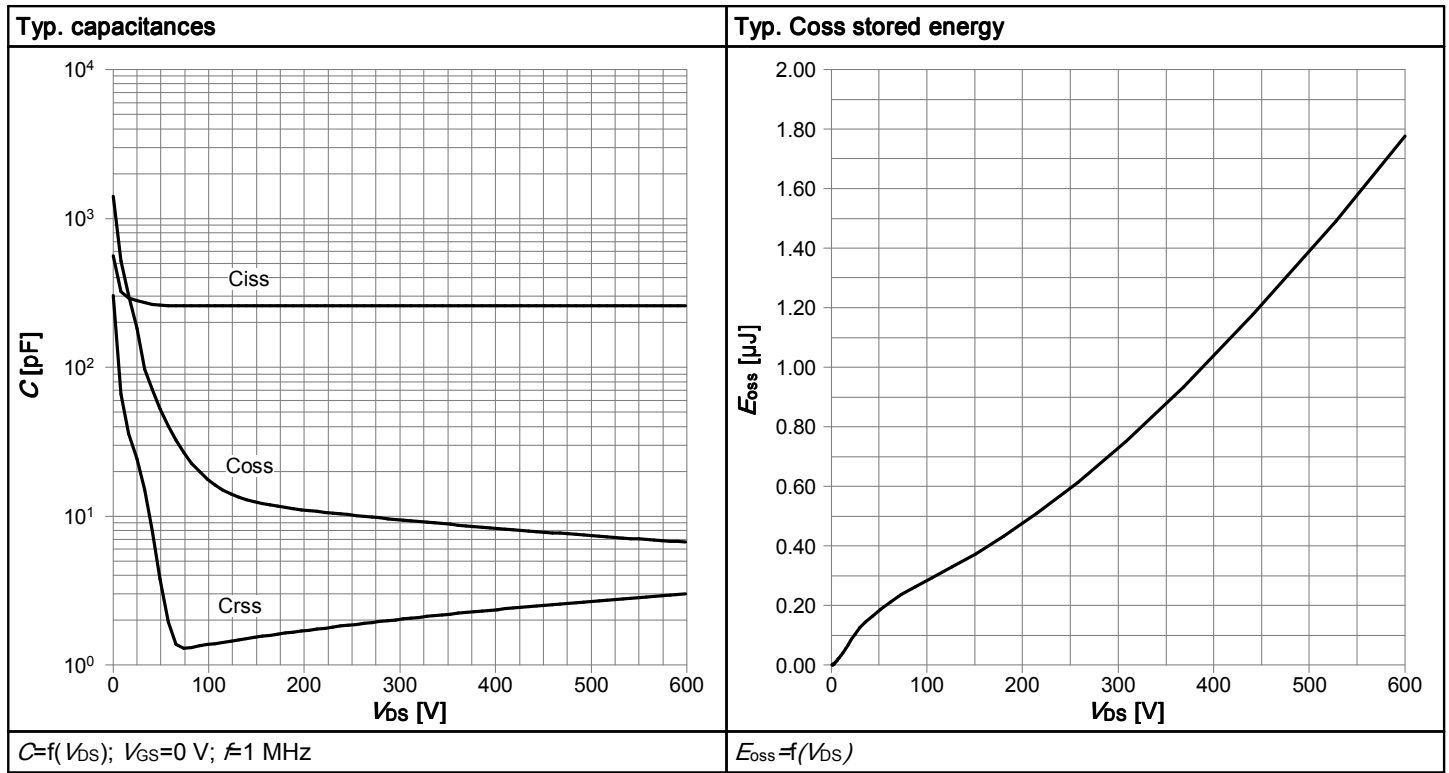
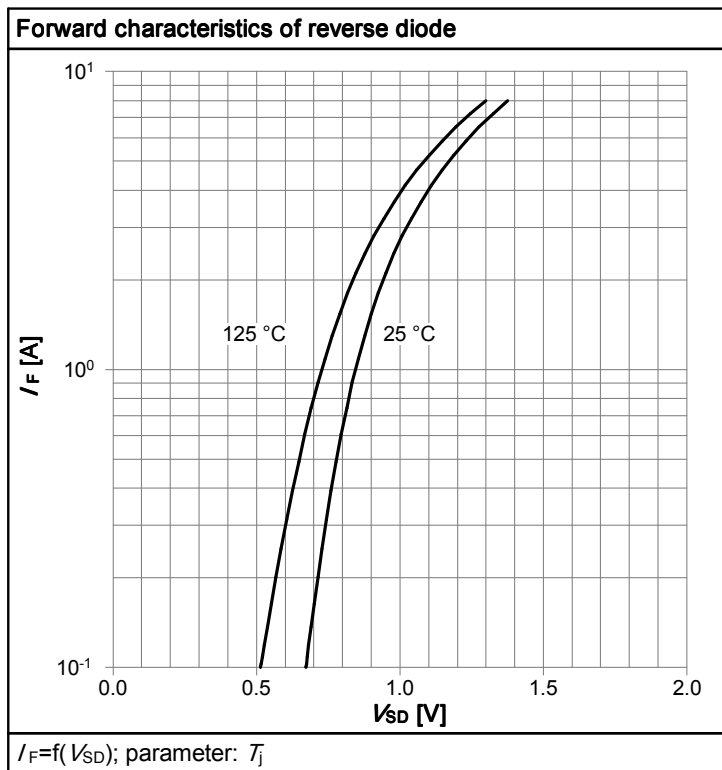
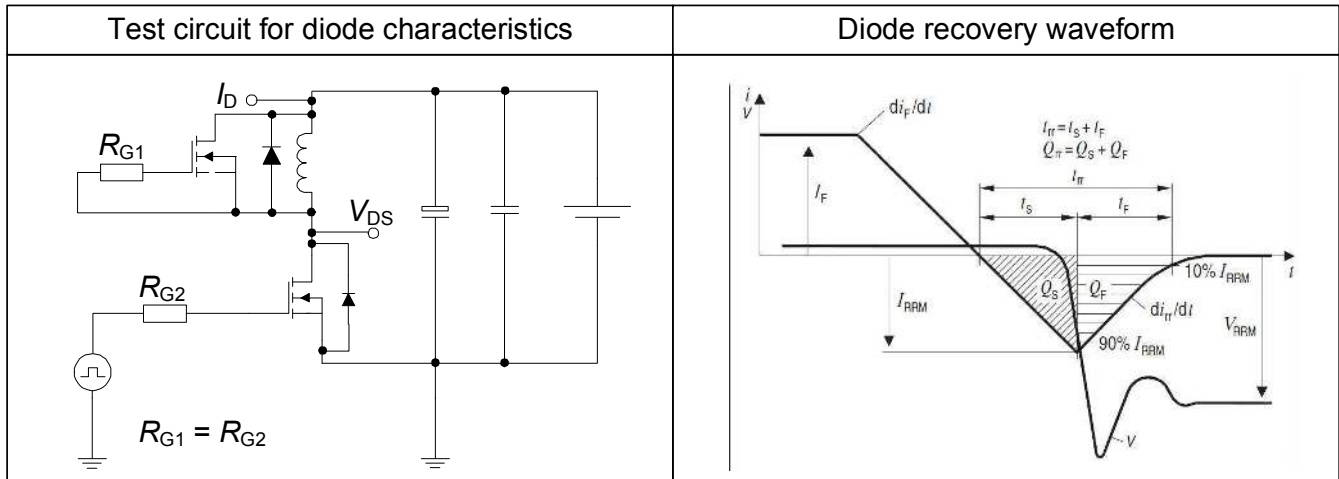
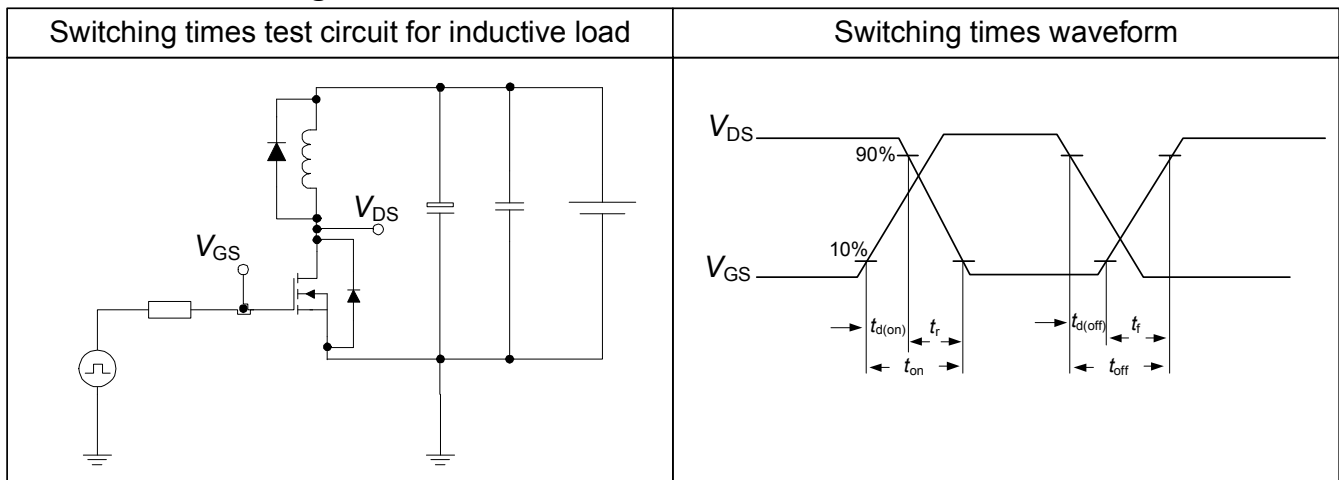
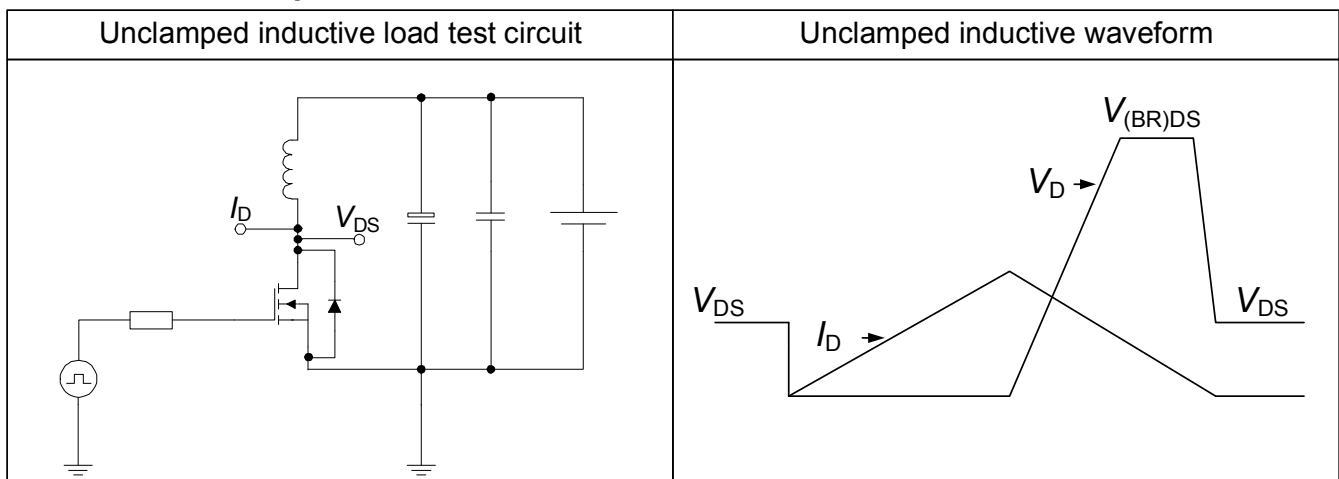

Table 15



6 Test Circuits

Table 16 Diode characteristics

Table 17 Switching times

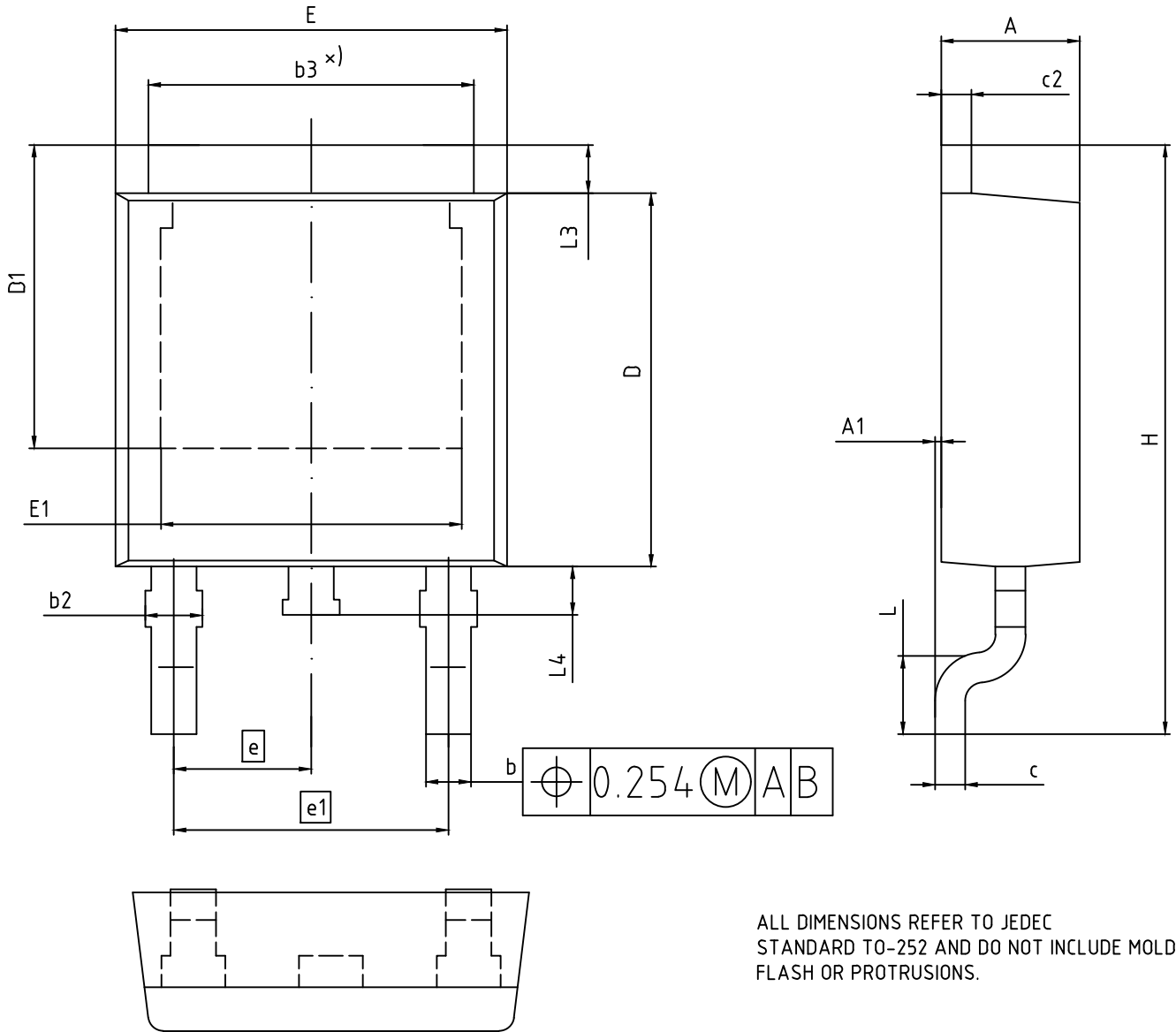
Table 18 Unclamped inductive

7 Package Outlines



ALL DIMENSIONS REFER TO JEDEC STANDARD TO-252 AND DO NOT INCLUDE MOLD FLASH OR PROTRUSIONS.

DIMENSION	MILLIMETERS	
	MIN.	MAX.
A	2.16	2.41
A1	0.00	0.15
b	0.64	0.89
b2	0.65	1.15
b3	4.95	5.50
c	0.46	0.61
c2	0.40	0.98
D	5.97	6.22
D1	5.02	5.84
E	6.35	6.73
E1	4.32	5.50
e	2.29	
e1	4.57	
N	3	
H	9.40	10.48
L	1.18	1.78
L3	0.89	1.27
L4	0.51	1.02

DOCUMENT NO. Z8B00003328
REVISION 07
SCALE: 10:1 0 1 2mm
EUROPEAN PROJECTION
ISSUE DATE 01.04.2020

Figure 1 Outline PG-TO 252, dimensions in mm/inches

8 Appendix A

Table 19 Related Links

- **IFX Design Tools:**
<http://www.infineon.com/cms/en/product/promopages/designtools/index.html>
- **IFX CoolMOS Webpage:**
<http://www.infineon.com/cms/en/product/channel.html?channel=ff80808112ab681d0112ab6a628704d8>

Revision History

IPD65R1K4CFD

Revision: 2020-05-26, Rev. 2.2

Previous Revision

Revision	Date	Subjects (major changes since last revision)
2.0	2012-07-17	Release of final version
2.2	2020-05-26	Update package outline

Trademarks

All referenced product or service names and trademarks are the property of their respective owners.

We Listen to Your Comments

Any information within this document that you feel is wrong, unclear or missing at all? Your feedback will help us to continuously improve the quality of this document. Please send your proposal (including a reference to this document) to:

erratum@infineon.com

Published by

Infineon Technologies AG

81726 München, Germany

© 2020 Infineon Technologies AG

All Rights Reserved.

Legal Disclaimer

The information given in this document shall in no event be regarded as a guarantee of conditions or characteristics ("Beschaffheitsgarantie").

With respect to any examples, hints or any typical values stated herein and/or any information regarding the application of the product, Infineon Technologies hereby disclaims any and all warranties and liabilities of any kind, including without limitation warranties of non-infringement of intellectual property rights of any third party.

In addition, any information given in this document is subject to customer's compliance with its obligations stated in this document and any applicable legal requirements, norms and standards concerning customer's products and any use of the product of Infineon Technologies in customer's applications.

The data contained in this document is exclusively intended for technically trained staff. It is the responsibility of customer's technical departments to evaluate the suitability of the product for the intended application and the completeness of the product information given in this document with respect to such application.

Information

For further information on technology, delivery terms and conditions and prices please contact your nearest Infineon Technologies Office (www.infineon.com).

Warnings

Due to technical requirements, components may contain dangerous substances. For information on the types in question, please contact the nearest Infineon Technologies Office.

The Infineon Technologies component described in this Data Sheet may be used in life-support devices or systems and/or automotive, aviation and aerospace applications or systems only with the express written approval of Infineon Technologies, if a failure of such components can reasonably be expected to cause the failure of that life-support, automotive, aviation and aerospace device or system or to affect the safety or effectiveness of that device or system. Life support devices or systems are intended to be implanted in the human body or to support and/or maintain and sustain and/or protect human life. If they fail, it is reasonable to assume that the health of the user or other persons may be endangered.