



Electromagnetic buzzers

With oscillator circuit

Pin terminal

SDC series

Pin terminal type

SDC1610

SDC1614

Caution

**The products in this catalog are not recommended
for new design**

Electromagnetic buzzers

With oscillator circuit

Pin terminal

Overview of the SDC series

PRODUCT LINEUP

Type	Part No.	Outside dimensions		Terminal pitch (mm)	Characteristics		Rated voltage Eo-p (V)
		Outside diameter (mm)	Height (mm)		Sound pressure dB(A)/10cm	Frequency (Hz)	
SDC1610	SDC1610M5-01	ø16	10	5	85	2400±20%	5
	SDC1610MT-01	ø16	10	5	85	2400±20%	12
SDC1614	SDC1614L5-01	ø16	14	5	85	1900±20%	5
	SDC1614LT-01	ø16	14	5	85	1900±20%	12

○ RoHS Directive Compliant Product: See the following for more details. <https://product.tdk.com/info/en/environment/rohs/index.html>

⚠ Please be sure to request delivery specifications that provide further details on the features and specifications of the products for proper and safe use. Please note that the contents may change without any prior notice due to reasons such as upgrading.

B U Z Z E R S



SDC1610M5-01 /ø16mm SDC1610MT-01 /ø16mm

FEATURES

- With a built-in oscillator, these electromagnetic buzzers require nothing more than connection to a DC power supply in order to produce acoustic output.
- Circuitry utilizes chip-type components for significantly reduced size and high reliability.

APPLICATION

Personal computers, office equipment, home appliances.

SHAPE & DIMENSIONS

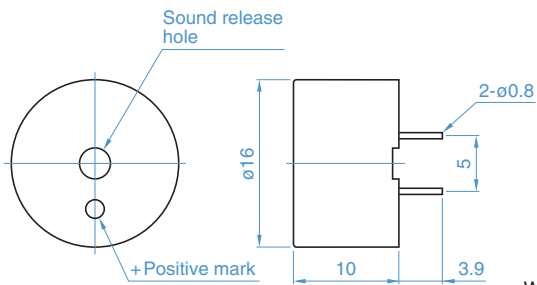

Weight: 5g
Dimensions in mm

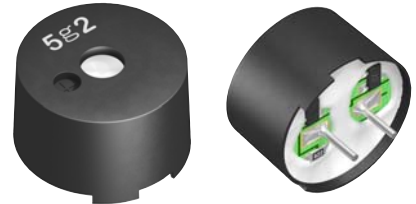

SPECIFICATIONS

Part No.	SDC1610M5-01	SDC1610MT-01
Rated voltage Edc(V)	5	12
Operating voltage Edc (V)	4 to 8	8 to 16
Frequency(Hz)*	2400±20%	2400±20%
Sound pressure(dB(A)/10cm)min.*	85	85
Average current(mA)max.*	30	25
Terminal construction	Pin terminal	Pin terminal
Operating temperature range	-10 to +70°C	
Storage temperature range	-20 to +80°C	

* Drive conditions: rated voltage

INPUT VOLTAGE VS. SOUND PRESSURE CHARACTERISTICS

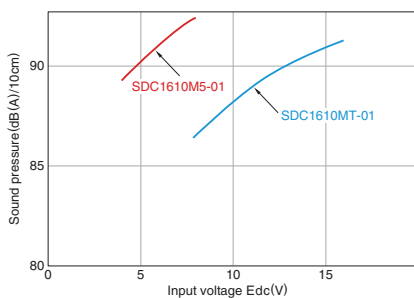

INPUT VOLTAGE VS. FREQUENCY CHARACTERISTICS

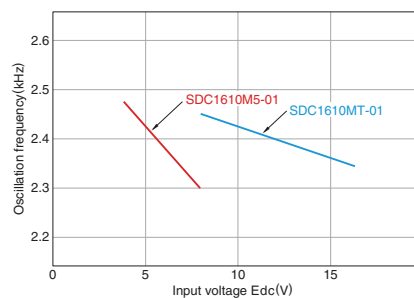

INPUT VOLTAGE VS. CURRENT CHARACTERISTICS

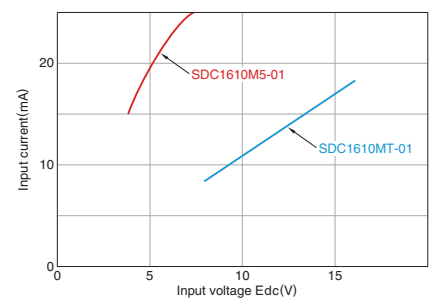

BUZZERS



SDC1614L5-01 /ø16mm SDC1614LT-01 /ø16mm

FEATURES

- With a built-in oscillator, these electromagnetic buzzers require nothing more than connection to a DC power supply in order to produce acoustic output.
- Oscillation frequency is a relatively low 1900Hz, producing a soft, pleasant sound.
- Circuitry utilizes chip-type components for significantly reduced size and high reliability.

APPLICATION

Personal computers, office automation equipment, other office equipment (electronic typewriters, ECRs, etc.), medical equipment, household appliances (microwave ovens, electronic jars, etc.)

SHAPE & DIMENSIONS

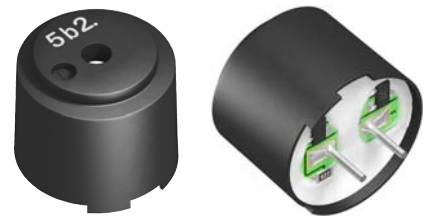
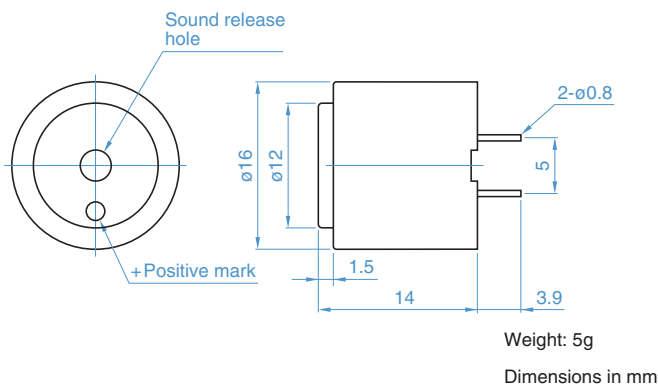

SPECIFICATIONS

Part No.	SDC1614L5-01	SDC1614LT-01
Rated voltage Edc(V)	5	12
Operating voltage Edc (V)	4 to 8	8 to 16
Frequency(Hz)*	1900±20%	1900±20%
Sound pressure(dB(A)/10cm)min.*	85	85
Average current(mA)max.*	30	25
Terminal construction	Pin terminal	Pin terminal
Operating temperature range	-10 to +70°C	
Storage temperature range	-20 to +80°C	

* Drive conditions: rated voltage

INPUT VOLTAGE VS. SOUND PRESSURE CHARACTERISTICS

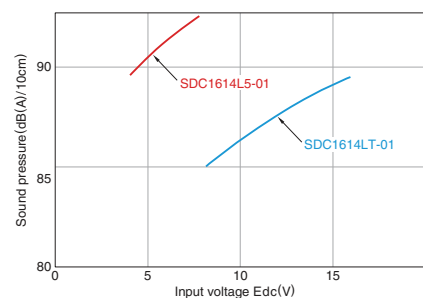

INPUT VOLTAGE VS. FREQUENCY CHARACTERISTICS

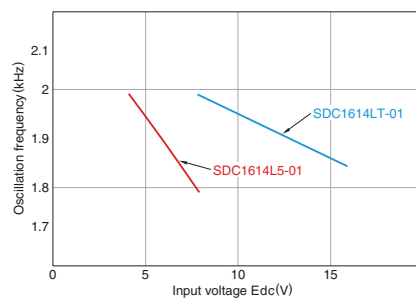

INPUT VOLTAGE VS. CURRENT CHARACTERISTICS

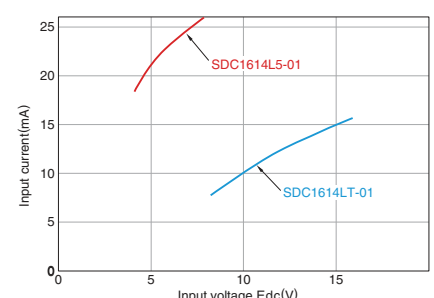

⚠ Please be sure to request delivery specifications that provide further details on the features and specifications of the products for proper and safe use. Please note that the contents may change without any prior notice due to reasons such as upgrading.

REMINDERS FOR USING THESE PRODUCTS

Before using these products, be sure to request the delivery specifications.

SAFETY REMINDERS

Please pay sufficient attention to the warnings for safe designing when using this products.

⚠ REMINDERS

Please be sure to read the specifications of TDK electromagnetic buzzer(hereinafter referred to as “the buzzer”) before use.

- Please pay sufficient attentions to the warnings for safe designing when using the buzzer.
Incorrect usage may cause smoke or fire.
- Do not make sound on the buzzer when it is close to ears.
Listening to the buzzer when it is close to ears, or continuant listening to it for an extended period, may result in hearing disorders.
Thoroughly warn consumers not to turn on the sound when the buzzer is close to ears.
- Do not exceed the rated operation voltage range when using the buzzer.
If it is exceeded beyond the rated operation voltage, a built-in coil may generate heat, resulting in deterioration of the coil, which may cause a drop in sound pressure or a change in the terminal resistance value.
If a rare short circuit occurs due to heat generated in the built-in coil, a large electrical current flows to the equipment used, possibly causing it to emit smoke or fire.
- The buzzer is a magnetic type sounder.
Do not use it for any other purpose than a sound generation.
- Do not use the buzzer in other than atmospheric air.
- Do not use the buzzer in the following environments (excluding cases in which countermeasures are taken).
 - Corrosive gases (Cl₂, NH₃, SO_x, NO_x, etc.)
 - Places to be exposed to dust.
 - Places where rain, fog, salt water, and the like will get on the buzzer.
- After installing the buzzer when designing an apparatus, confirm that there are no abnormalities by performing a reliability evaluation test.
- Do not exceed the rated operating temperature range when using the buzzer.
- Do not use for an extended period at relative humidity in excess of 90% (maximum wet-bulb temperature of 38 °C).
- When using the buzzer for a safety device or warning device, take all surest measures such as providing a safety circuit or the joint use of another sounder with equivalent characteristics in order to prevent accidents.
- The buzzer may be influenced by electromagnetic waves, voltage changes, and ripple voltage.
Check the buzzer in the mounted condition, and take measures such as safety circuits, shielding, etc.
- If the buzzer is molded or secured by adhesives, thermal expansion stresses from the mold or adhesive agent may cause deterioration in a soldered terminal part.
Before molding or securing an adhesive, consider the type, amount, hardening conditions, adhesive properties, etc., of the sealing material, and confirm the reliability.
- Do not apply vibrations or shocks (such as dropping) larger than the specified.
- Do not bend the terminal pin when soldering to install on a circuit board.
- Do not apply larger than the specified force to the terminal pin.
- Do not apply force to the terminal pin at high temperatures (when soldering).
- When soldering a terminal pin, perform the soldering in clean conditions without contamination or rust in order to avoid poor connections.
- When performing dip soldering directly for installing on a printed circuit board, be careful so that smoke from the flux, or other foreign materials, will not get into the sound emission hole.
- Do not clean(excluding products that can be cleaned).
- With regards to devices in which the consumers can touch the buzzer, thoroughly warn consumers not to put foreign materials (such as needles, hairpins, garbage, etc.) into the sound emission hole.
- As the buzzer uses a coil, it has an inductive load.
Protect the drive circuit by putting the diodes in parallel into the buzzer.

B U Z Z E R S



- Do not reconfigure the buzzer.
- Sound pressure changes depending on the shape of the part to be installed in a device, or the installation location. Check the buzzer in the mounted condition.
- The buzzer has polarities.
When installing, be careful not to make a mistake with the polarities. Incorrect polarities will cause the following irregularities.
 - Without circuit type: differences in sound pressure will be created.
 - With circuit type: no sound will be generated.
- Frequencies other than the rated frequency will change the characteristics (sound pressure), and may cause wide unevenness.
- As the buzzer uses a magnet, it generates a surrounding magnetic field.
When designing a device, etc., confirm that there are no irregularities due to the magnetic field.
- Check the buzzer in the mounted condition, and take measures such as shielding, etc.
The characteristics of the buzzer may change because of the influence of an outside magnetic field.
- Because of deterioration or damage, maintain in rated storage temperature range, avoid environments where there are sudden temperature changes, direct sunlight, corrosive gases and dust, and store wrapped in order to avoid applying stresses.
- High safety and reliability is needed, and or, there is fear that failure, wrong movement, failure of product damages and worldly goods etc related to life and health of people, or do not use for equipment (as nuclear power equipment-automobile-aircraft-medical device) with fear that significant influence is had socially.
- The products listed on this catalog are intended for use in general electronic equipment (AV equipment, telecommunications equipment, home appliances, amusement equipment, computer equipment, personal equipment, office equipment, measurement equipment, industrial robots) under a normal operation and use condition.
The products are not designed or warranted to meet the requirements of the applications listed below, whose performance and/or quality require a more stringent level of safety or reliability, or whose failure, malfunction or trouble could cause serious damage to society, person or property.
If you intend to use the products in the applications listed below or if you have special requirements exceeding the range or conditions set forth in the each catalog, please contact us.

- (1) Aerospace/aviation equipment
- (2) Transportation equipment (cars, electric trains, ships, etc.)
- (3) Medical equipment
- (4) Power-generation control equipment
- (5) Atomic energy-related equipment
- (6) Seabed equipment
- (7) Transportation control equipment

- (8) Public information-processing equipment
- (9) Military equipment
- (10) Electric heating apparatus, burning equipment
- (11) Disaster prevention/crime prevention equipment
- (12) Safety equipment
- (13) Other applications that are not considered general-purpose applications