

0.472 [12.00] MAX
CABLE DIAMETER

GROUNDING
SCREW
(PHILLIPS)



HOUSING
SCREW
(PHILLIPS)



MOUNTING
SCREW
(PHILLIPS)



CABLE
SLOT
COVER

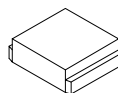

CABLE DIAMETER

0.472 [12.00] MAX

MATERIAL:

BACKSHELL: ZINC ALLOY
 COVER: ZINC ALLOY
 MOUNTING SCREWS: STEEL, NICKEL PLATED
 HOUSING SCREWS: STEEL, ZINC PLATED
 GROUNDING SCREW: STEEL, ZINC PLATED
 CABLE SLOT COVER: ZINC ALLOY
 OPERATING TEMP: -55°C TO +90°C

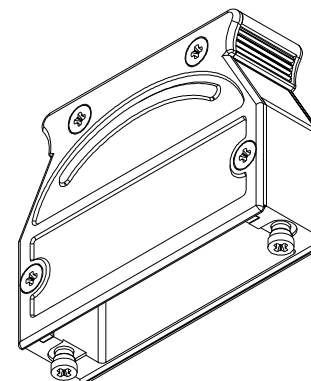

BACKSHELL KIT INCLUDES:

- (1) BACKSHELL
- (1) BACKSHELL COVER
- (2) MOUNTING SCREWS (#4-40)
- (4) HOUSING SCREWS (M2.5x0.45)
- (1) GROUNDING SCREW (M2.5x0.45)
- (2) CABLE SLOT COVER

**SEE PAGE 2 FOR CABLE CLAMPS

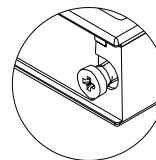

Mounting screw(s) shown to the left will not mate with any NorComp current hardware options. Please refer to NorComp 975M Series product page for slide lock hardware options (purchased separately).

UNITS = inch [mm]

DO NOT SCALE FROM DRAWING

RoHS COMPLIANT



THESE DRAWINGS AND SPECIFICATIONS ARE THE PROPERTY OF NorComp AND SHALL NOT BE REPRODUCED, COPIED OR USED AS THE BASIS FOR THE MANUFACTURE OR SALE OF APPARATUS WITHOUT WRITTEN PERMISSION.

DRAWN:
M. SIGMON

DATE:
01/14/2014

NorComp

SCALE:
NTS

SHEET 1 OF 2

REV 3

DWG NO.

975M025-030R121

CABLE CLAMPS ORDERED SEPARATELY

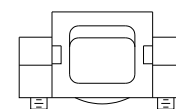
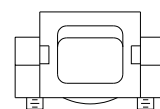
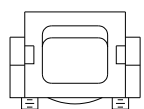
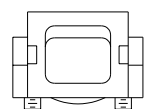
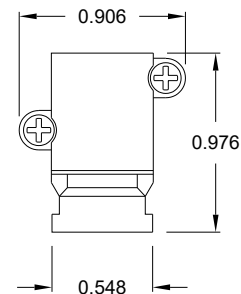
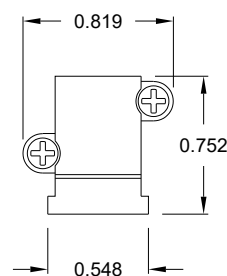
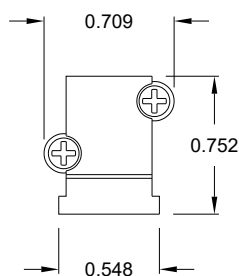
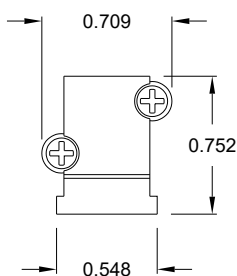
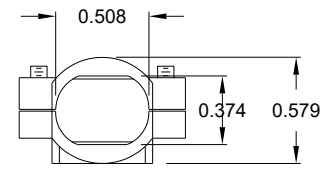
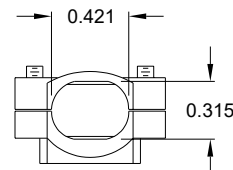
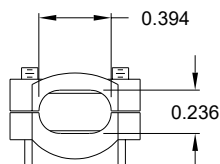
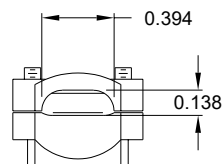

P/N 955-09-SR-4-7
CABLE RANGE = 0.157 - 0.276

P/N 955-15-SR-7-10
CABLE RANGE = 0.276 - 0.394

P/N 955-25-SR-9-12
CABLE RANGE = 0.354 - 0.472

P/N 955-37-SR-11-14
CABLE RANGE = 0.433 - 0.551

RoHS COMPLIANT

UNITS = inch

DO NOT SCALE FROM DRAWING



THESE DRAWINGS AND SPECIFICATIONS ARE THE PROPERTY OF NorComp AND SHALL NOT BE REPRODUCED, COPIED OR USED AS THE BASIS FOR THE MANUFACTURE OR SALE OF APPARATUS WITHOUT WRITTEN PERMISSION.

DRAWN:
M. SIGMON

DATE:
01/14/2014

NorComp

SCALE:
NTS

SHEET 2 OF 2

REV 3

DWG NO.

975M025-030R121