

FEATURES

- Dual differential transmitters (Tx)
- Dual differential receivers (Rx)
- Observation receiver (ORx) with 2 inputs
- Sniffer receiver (SnRx) with 3 inputs
- Tunable range: 300 MHz to 6000 MHz
- Tx synthesis bandwidth (BW) to 250 MHz
- Rx BW: 8 MHz to 100 MHz
- Supports frequency division duplex (FDD) and time division duplex (TDD) operation
- Fully integrated independent fractional-N radio frequency (RF) synthesizers for Tx, Rx, ORx, and clock generation
- JESD204B digital interface

APPLICATIONS

- 3G/4G micro and macro base stations (BTS)
- 3G/4G multicarrier picocells
- FDD and TDD active antenna systems
- Microwave, nonline of sight (NLOS) backhaul systems

GENERAL DESCRIPTION

The AD9371 is a highly integrated, wideband RF transceiver offering dual channel transmitters and receivers, integrated synthesizers, and digital signal processing functions. The IC delivers a versatile combination of high performance and low power consumption required by 3G/4G micro and macro BTS equipment in both FDD and TDD applications. The AD9371 operates from 300 MHz to 6000 MHz, covering most of the licensed and unlicensed cellular bands. The IC supports receiver bandwidths up to 100 MHz. It also supports observation receiver and transmit synthesis bandwidths up to 250 MHz to accommodate digital correction algorithms.

The transceiver consists of wideband direct conversion signal paths with state-of-the-art noise figure and linearity. Each complete receiver and transmitter subsystem includes dc offset correction, quadrature error correction (QEC), and programmable digital filters, eliminating the need for these functions in the digital baseband. Several auxiliary functions such as an auxiliary analog-to-digital converter (ADC), auxiliary digital-to-analog converters (DACs), and general-purpose input/outputs (GPIOs) are integrated to provide additional monitoring and control capability.

An observation receiver channel with two inputs is included to monitor each transmitter output and implement interference mitigation and calibration applications. This channel also connects to three sniffer receiver inputs that can monitor radio activity in different bands.

FUNCTIONAL BLOCK DIAGRAM

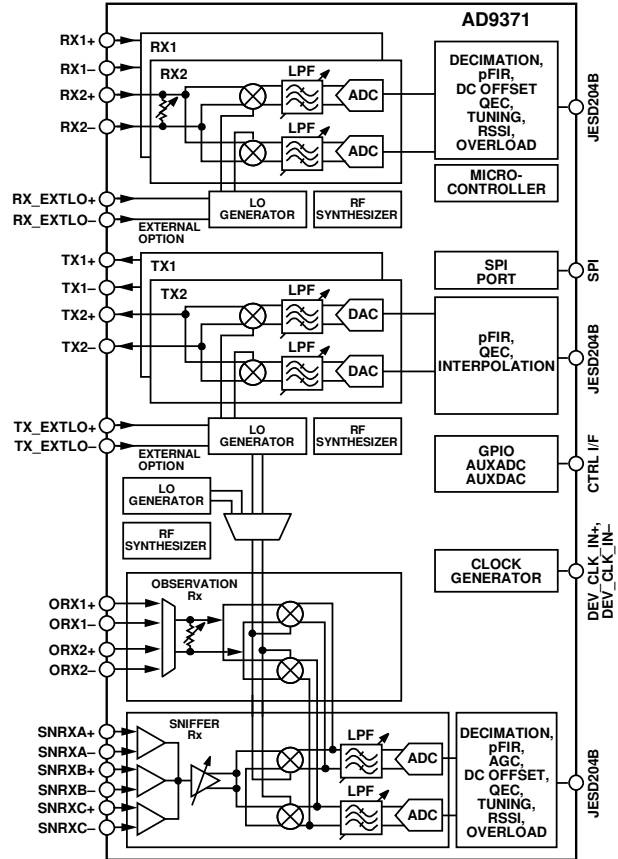

NOTES
1. FOR JESD204B PINS, SEE FIGURE 4.

Figure 1.

The high speed JESD204B interface supports lane rates up to 6144 Mbps. Four lanes are dedicated to the transmitters and four lanes are dedicated to the receiver and observation receiver channels.

The fully integrated phase-locked loops (PLLs) provide high performance, low power fractional-N frequency synthesis for the transmitter, the receiver, the observation receiver, and the clock sections. Careful design and layout techniques provide the isolation demanded in high performance base station applications. All voltage controlled oscillator (VCO) and loop filter components are integrated to minimize the external component count.

A 1.3 V supply is required to power the core of the AD9371, and a standard 4-wire serial port controls it. Other voltage supplies provide proper digital interface levels and optimize transmitter and auxiliary converter performance. The AD9371 is packaged in a 12 mm × 12 mm, 196-ball chip scale ball grid array (CSP_BGA).

Rev. B

Document Feedback

Information furnished by Analog Devices is believed to be accurate and reliable. However, no responsibility is assumed by Analog Devices for its use, nor for any infringements of patents or other rights of third parties that may result from its use. Specifications subject to change without notice. No license is granted by implication or otherwise under any patent or patent rights of Analog Devices. Trademarks and registered trademarks are the property of their respective owners.

TABLE OF CONTENTS

Features	1	5.5 GHz Band.....	46
Applications.....	1	Theory of Operation	54
General Description	1	Transmitter (Tx).....	54
Functional Block Diagram	1	Receiver (Rx).....	54
Revision History	2	Observation Receiver (ORx).....	54
Specifications.....	3	Sniffer Receiver (SnRx)	54
Current and Power Consumption Specifications.....	9	Clock Input.....	54
Timing Specifications	10	Synthesizers.....	55
Absolute Maximum Ratings.....	12	Serial Peripheral Interface (SPI) Interface	55
Reflow Profile.....	12	GPIO_x AND GPIO_3P3_x Pins	55
Thermal Resistance	12	Auxiliary Converters.....	55
ESD Caution.....	12	JESD204B Data Interface	55
Pin Configuration and Function Descriptions.....	13	Power Supply Sequence	56
Typical Performance Characteristics	16	JTAG Boundary Scan.....	56
700 MHz Band	16	Outline Dimensions	57
2.6 GHz Band	26	Ordering Guide	57
3.5 GHz Band.....	36		

REVISION HISTORY

3/2017—Rev. A to Rev. B

Change to Table 1.....	6
Deleted Figure 230 through Figure 239; Renumbered Sequentially	55
Changes to Sniffer Receiver (SnRx) Section	55

11/2016—Rev. 0 to Rev. A

Changes to Table 1.....	6
Changes to Table 2.....	9
Changes to L3, L4 Description Column, Table 6; M3, M4 Description Column, Table 6; and M13, M14 Description Column, Table 6.....	16
Changes to Figure 46 Caption.....	23
Changes to Figure 48 Caption.....	24
Changes to Figure 56 Caption and Figure 57 Caption	25
Changes to Figure 82 Caption.....	30

Changes to Figure 105 Caption	33
Changes to Figure 107 Caption	34
Changes to Figure 115 Caption and Figure 116 Caption	35
Changes to Figure 141 Caption	40
Changes to Figure 164 Caption	43
Changes to Figure 166 Caption	44
Changes to Figure 174 Caption and Figure 175	45
Changes to Figure 194 and Figure 199 Caption	49
Changes to Figure 222 Caption	53
Changes to Figure 224 Caption	54
Added Figure 230 to Figure 235; Renumbered Sequentially....	55
Added Figure 236 to Figure 239	56
Added External LO Inputs Section	58

7/2016—Revision 0: Initial Version

SPECIFICATIONS

Electrical characteristics at ambient temperature range, VDDA_SER = 1.3 V, VDDA_DES = 1.3 V, JESD_VTT_DES = 1.3 V, VDDA_1P3¹ = 1.3 V, VDIG = 1.3 V, VDDA_1P8 = 1.8 V, VDD_IF = 2.5 V, and VDDA_3P3 = 3.3 V; all RF specifications based on measurements that include printed circuit board (PCB) and matching circuit losses, unless otherwise noted.

Table 1.

Parameter	Symbol	Min	Typ	Max	Unit	Test Conditions/Comments
TRANSMITTERS (Tx)						
Center Frequency		300		6000	MHz	
Tx Large Signal Bandwidth (BW)				100	MHz	
Tx Synthesis BW ²				250	MHz	Wider bandwidth for use in digital processing algorithms
BW Flatness			±0.5		dB	250 MHz BW, compensated by programmable finite infinite response (FIR) filter
			±0.15		dB	Any 20 MHz BW span, compensated by programmable FIR filter
Deviation from Linear Phase			10		Degrees	250 MHz BW
Power Control Range		0		42	dB	Increased calibration time, reduced QEC ³ , LOL ⁴ performance beyond 20 dB
Power Control Resolution			0.05		dB	
ACLR ⁵ (Four Universal Mobile Telecommunications System (UMTS) Carriers)						-11.2 dBFS rms, 0 dB RF attenuation
700 MHz Local Oscillator (LO)			-64		dB	
2600 MHz LO			-64		dB	
3500 MHz LO			-63		dB	
5500 MHz LO			-61		dB	
In-Band Noise			-155		dBFS ⁶ /Hz	
Tx to Tx Isolation						
700 MHz LO			70		dB	
2600 MHz LO			65		dB	
3500 MHz LO			65		dB	
5500 MHz LO			65		dB	
Image Rejection						Up to 20 dB RF attenuation, within large signal BW, QEC ³ active
700 MHz LO			65		dB	
2600 MHz LO			65		dB	
3500 MHz LO			65		dB	
5500 MHz LO			50		dB	
Maximum Output Power						0 dBFS, 1 MHz signal input, 50 Ω load, 0 dB RF attenuation
700 MHz LO			7		dBm	
2600 MHz LO			7		dBm	
3500 MHz LO			6		dBm	
5500 MHz LO			4		dBm	
Output Third-Order Intercept Point	OIP3					-5 dBFS rms, 0 dB RF attenuation
700 MHz LO			27		dBm	
2600 MHz LO			27		dBm	
3500 MHz LO			25		dBm	
5500 MHz LO			25		dBm	

Parameter	Symbol	Min	Typ	Max	Unit	Test Conditions/Comments
Carrier Leakage						After calibration, LOL correction active, CW ⁷ input signal, 3 dB RF and 3 dB digital attenuation, 40 kHz measurement BW
700 MHz LO			-81		dBFS ⁶	
2600 MHz LO			-81		dBFS ⁶	
3500 MHz LO			-81		dBFS ⁶	
5500 MHz LO			-75		dBFS ⁶	
Error Vector Magnitude (3GPP Test Signals)	EVM					Long-term evolution (LTE) 20 MHz downlink, 5 dB RF attenuation
700 MHz LO			-45		dB	
2600 MHz LO			-39		dB	
3500 MHz LO			-38.5		dB	
5500 MHz LO			-37.5		dB	
Output Impedance			50		Ω	Differential
RECEIVERS (Rx)						
Center Frequency		300		6000	MHz	
Gain Range		0		30	dB	
Analog Gain Step			0.5		dB	
BW Ripple			±0.5		dB	100 MHz BW, compensated by programmable FIR filter
			±0.2		dB	Any 20 MHz span, compensated by programmable FIR filter
Rx Bandwidth		8		100	MHz	Analog low-pass filter (LPF) BW is 20 MHz minimum, programmable FIR BW configurable over the entire range
Rx Alias Band Rejection		75			dB	Due to digital filters
Maximum Recommended Input Power ⁸			-14		dBm	Input is a CW ⁷ signal at a 0 dB attenuation setting; this level increases decibel for decibel with attenuation
Noise Figure	NF					Maximum Rx gain, at Rx port, matching losses de-embedded
700 MHz LO			12		dB	
2600 MHz LO			13.5		dB	
3500 MHz LO			14		dB	
5500 MHz LO			18		dB	
Input Third-Order Intercept Point	IIP3					Maximum Rx gain, third-order intermodulation (IM3) 1 MHz offset from LO
700 MHz LO			22		dBm	
2600 MHz LO			22		dBm	
3500 MHz LO			20		dBm	
5500 MHz LO			20		dBm	
Input Second-Order Intercept Point	IIP2					Maximum Rx gain, second-order intermodulation (IM2) 1 MHz offset from LO
700 MHz LO			65		dBm	
2600 MHz LO			65		dBm	
3500 MHz LO			65		dBm	
5500 MHz LO			57		dBm	

Parameter	Symbol	Min	Typ	Max	Unit	Test Conditions/Comments
Image Rejection						QEC ³ active, within Rx BW
700 MHz LO			75		dB	
2600 MHz LO			75		dB	
3500 MHz LO			75		dB	
5500 MHz LO			75		dB	
Input Impedance			200		Ω	Differential
Tx1 to Rx1 Signal Isolation and Tx2 to Rx2 Signal Isolation						
700 MHz LO			68		dB	
2600 MHz LO			68		dB	
3500 MHz LO			62		dB	
5500 MHz LO			60		dB	
Tx1 to Rx2 Signal Isolation and Tx2 to Rx1 Signal Isolation						
700 MHz LO			70		dB	
2600 MHz LO			70		dB	
3500 MHz LO			62		dB	
5500 MHz LO			60		dB	
Rx1 to Rx2 Signal Isolation						
700 MHz LO			60		dB	
2600 MHz LO			60		dB	
3500 MHz LO			60		dB	
5500 MHz LO			60		dB	
Rx Band Spurs Referenced to RF Input at Maximum Gain			-95		dBm	No more than one spur at this level per 10 MHz of Rx BW; excludes harmonics of the reference clock
Rx LO Leakage at Rx Input at Maximum Gain						Leakage decreases decibel for decibel with attenuation for first 12 dB
700 MHz LO			-65		dBm	
2600 MHz LO			-65		dBm	
3500 MHz LO			-62		dBm	
5500 MHz LO			-62		dBm	
OBSERVATION RECEIVER (ORx)						
Center Frequency		300		6000	MHz	
Gain Range		0		18	dB	
Analog Gain Step			1		dB	
BW Ripple			±0.5		dB	250 MHz RF BW, compensated by programmable FIR filter
Deviation from Linear Phase			10		Degrees	250 MHz RF BW
ORx Bandwidth				250	MHz	
ORx Alias Band Rejection		60			dB	Due to digital filters
Maximum Recommended Input Power ⁸			-13		dBm	Input is a CW ⁷ signal at 0 dB attenuation setting; this level increases decibel for decibel with attenuation
Signal-to-Noise Ratio ⁹	SNR					Maximum gain at ORx port
700 MHz LO			60		dB	
2600 MHz LO			60		dB	
3500 MHz LO			60		dB	
5500 MHz LO			59		dB	200 MHz BW, 245.76 MSPS

Parameter	Symbol	Min	Typ	Max	Unit	Test Conditions/Comments
Input Third-Order Intercept Point	IIP3					Maximum ORx gain, IM3 1 MHz offset from LO
700 MHz LO			22		dBm	
2600 MHz LO			22		dBm	
3500 MHz LO			18		dBm	
5500 MHz LO			18		dBm	
Input Second-Order Intercept Point	IIP2					Maximum ORx gain, IM2 1 MHz offset from LO
700 MHz LO			65		dBm	
2600 MHz LO			65		dBm	
3500 MHz LO			65		dBm	
5500 MHz LO			60		dBm	
Image Rejection						After online tone calibration
700 MHz LO			65		dB	
2600 MHz LO			65		dB	
3500 MHz LO			65		dB	
5500 MHz LO			65		dB	
Input Impedance			200		Ω	Differential
Tx1 to ORx1 Signal and Tx2 to ORx2 Signal Isolation						
700 MHz LO			70		dB	
2600 MHz LO			70		dB	
3500 MHz LO			70		dB	
5500 MHz LO			70		dB	
Tx1 to ORx2 Signal and Tx2 to ORx1 Signal Isolation						
700 MHz LO			70		dB	
2600 MHz LO			70		dB	
3500 MHz LO			70		dB	
5500 MHz LO			70		dB	
SNIFFER RECEIVER (SnRx)						
Center Frequency		300		4000	MHz	
Gain Range		0		52	dB	
Analog Gain Step			1		dB	
BW Ripple			± 0.5		dB	20 MHz RF BW, compensated by programmable FIR filter
Rx Bandwidth				20	MHz	
Rx Alias Band Rejection		60			dB	Due to digital filters
Maximum Recommended Input Power ³			-26		dBm	Input is a CW ⁷ signal at 0 dB attenuation setting
Noise Figure	NF					Maximum gain at SnRx port, matching losses de-embedded, gain control limited to the first 20 steps
700 MHz LO			5		dB	
2600 MHz LO			5		dB	
3500 MHz LO			7		dB	
Input Third-Order Intercept Point	IIP3					Maximum gain, IM3 1 MHz offset from LO, gain control limited to the first 20 steps
700 MHz LO			1		dBm	
2600 MHz LO			1		dBm	
3500 MHz LO			1		dBm	

Parameter	Symbol	Min	Typ	Max	Unit	Test Conditions/Comments
Input Second-Order Intercept Point	IIP2					Maximum gain, IM2 1 MHz offset from LO, gain control limited to the first 20 steps
700 MHz LO			45		dBm	
2600 MHz LO			45		dBm	
3500 MHz LO			45		dBm	
Image Rejection						After online tone calibration
700 MHz LO			75		dB	
2600 MHz LO			75		dB	
3500 MHz LO			75		dB	
Input Impedance			400		Ω	Differential
Tx1 to SnRx Signal and Tx2 to SnRx Signal Isolation						Applies to each SnRx input
700 MHz LO			60		dB	
2600 MHz LO			60		dB	
3500 MHz LO			60		dB	
LO SYNTHESIZER						
LO Frequency Step			2.3		Hz	1.5 GHz to 3 GHz, 76.8 MHz phase frequency detector (PFD) frequency
LO Spectral Purity			-80		dBc	Excludes integer boundary spurs 1 kHz to 100 MHz
Spot Phase Noise						
700 MHz LO						
10 kHz			-104		dBc	
100 kHz			-107		dBc	
1 MHz			-133		dBc	
2600 MHz LO						
10 kHz			-93		dBc	
100 kHz			-97		dBc	
1 MHz			-123		dBc	
3500 MHz LO						
10 kHz			-91		dBc	
100 kHz			-97		dBc	
1 MHz			-123		dBc	
5500 MHz LO						
10 kHz			-98		dBc	
100 kHz			-100		dBc	
1 MHz			-110		dBc	
Integrated Phase Noise						Integrated from 1 kHz to 100 MHz
700 MHz LO			0.20		$^{\circ}$ rms	
2600 MHz LO			0.49		$^{\circ}$ rms	
3500 MHz LO			0.55		$^{\circ}$ rms	
5500 MHz LO			0.75		$^{\circ}$ rms	
EXTERNAL LO INPUT						
Input Frequency	f_{EXTLO}	600		8000	MHz	Input frequency must be 2x the desired LO frequency
Input Signal Power		0	3	6	dBm	50 Ω matching at the source

Parameter	Symbol	Min	Typ	Max	Unit	Test Conditions/Comments
REFERENCE CLOCK (DEV_CLK_IN SIGNAL) Frequency Range Signal Level		10 0.3		320 2.0	MHz V p-p	AC-coupled, common-mode voltage (V_{CM}) = 618 mV; for best spurious performance, use a <1 V p-p input clock
AUXILIARY CONVERTERS ADC ADC Resolution Input Voltage Minimum Maximum DAC DAC Resolution Output Voltage Minimum Maximum Drive Capability			12 0.25 3.05 10 0.5 3.0 10		Bits V V Bits V V mA	Includes four offset levels Reference voltage (V_{REF}) = 1 V $V_{REF} = 2.5$ V
DIGITAL SPECIFICATIONS (CMOS), GPIO_x, RX1_ENABLE, RX2_ENABLE, TX1_ENABLE, TX2 ENABLE, SYNCINBx+, SYNCOUtb0+, GP_INTERRUPT, SDIO, SDO, SCLK, CSB, RESET Logic Inputs Input Voltage High Level Low Level Input Current High Level Low Level Logic Outputs Output Voltage High Level Low Level Drive Capability		$V_{DD_IF} \times 0.8$ 0 -10 -10 $V_{DD_IF} \times 0.8$		V_{DD_IF} $V_{DD_IF} \times 0.2$ +10 +10 $V_{DD_IF} \times 0.2$	V V μ A μ A V V mA	
DIGITAL SPECIFICATIONS (LVDS), SYSREF_INx, SYNCOUtb0 \pm , SYNCINBx PAIRS Logic Inputs Input Voltage Range Input Differential Voltage Threshold Receiver Differential Input Impedance		825 -100	100	1675 +100	mV mV Ω	Each differential input in the pair Internal termination enabled

Parameter	Symbol	Min	Typ	Max	Unit	Test Conditions/Comments
Logic Outputs						
Output Voltage						
High				1375	mV	
Low		1025			mV	
Differential			225		mV	
Offset			1200		mV	
DIGITAL SPECIFICATIONS (CMOS), GPIO_3P3_x SIGNALS						
Logic Inputs						
Input Voltage						
High Level		VDDA_3P3 × 0.8		VDDA_3P3	V	
Low Level		0		VDDA_3P3 × 0.2	V	
Input Current						
High Level		-10		+10	μA	
Low Level		-10		+10	μA	
Logic Outputs						
Output Voltage						
High Level		VDDA_3P3 × 0.8			V	
Low Level				VDDA_3P3 × 0.2	V	
Drive Capability			4		mA	

¹ VDDA_1P3 refers to all analog 1.3 V supplies including the following: VDDA_BB, VDDA_CLKSYNTH, VDDA_TXLO, VDDA_RXRF, VDDA_RXSYNTH, VDDA_RXVCO, VDDA_RXTX, VDDA_TXSYNTH, VDDA_TXVCO, VDDA_CALPLL, VDDA_SNRXSYNTH, VDDA_SNRXVCO, VDDA_CLK, and VDDA_RXLO.

² Synthesis bandwidth (BW) is the extended bandwidth used by digital correction algorithms to measure conditions and generate compensation.

³ Quadrature error correction (QEC) is the system for minimizing quadrature images of a desired signal.

⁴ Local oscillator leakage (LOL) is a measure of the amount of the LO signal that is passed from a mixer with the desired signal.

⁵ Adjacent channel level reduction (ACLR) is a measure of the amount of power from the desired signal leaking into an adjacent channel.

⁶ dBFS represents the ratio of the actual output signal to the maximum possible output level for a continuous wave output signal at the given RF attenuation setting.

⁷ Continuous wave (CW) is a single frequency signal.

⁸ Note that the input signal power limit does not correspond to 0 dBFS at the digital output because of the nature of the continuous time Σ - Δ ADCs. Unlike the hard clipping characteristic of pipeline ADCs, these converters exhibit a soft overload behavior when the input approaches the maximum level.

⁹ Signal-to-noise ratio is limited by the baseband quantization noise.

CURRENT AND POWER CONSUMPTION SPECIFICATIONS

Table 2.

Parameter	Min	Typ	Max	Unit	Test Conditions / Comments
SUPPLY CHARACTERISTICS					
VDDA_1P3 Analog Supplies ¹	1.267	1.3	1.33	V	CMOS and LVDS supply, 1.8 V to 2.5 V nominal range
VDIG Supply	1.267	1.3	1.33	V	
VDDA_1P8 Supply	1.71	1.8	1.89	V	
VDD_IF Supply	1.71	1.8	2.625	V	
VDDA_3P3 Supply	3.135	3.3	3.465	V	
VDDA_SER, VDDA_DES, JESD_VTT_DES Supplies	1.14	1.3	1.365	V	
POSITIVE SUPPLY CURRENT (Rx MODE)					Two Rx channels enabled, Tx upconverter disabled, 100 MHz Rx BW, 122.88 MSPS data rate
VDDA_1P3 Analog Supplies ¹		1055		mA	Rx QEC ² enabled, QEC ² engine active
VDIG Supply		625		mA	
VDD_IF Supply (CMOS and LVDS)		8		mA	No auxiliary DACs or auxiliary ADCs enabled; if enabled, the auxiliary ADC adds 2.7 mA, and each auxiliary ADC adds 1.5 mA
VDDA_3P3 Supply		1		mA	
VDDA_SER, VDDA_DES, JESD_VTT_DES Supplies		375		mA	
Total Power Dissipation		2.70		W	

Parameter	Min	Typ	Max	Unit	Test Conditions / Comments
POSITIVE SUPPLY CURRENT (Tx MODE)					Two Tx channels enabled, Rx downconverter disabled, 200 MHz Tx BW, 245.76 MSPS data rate (ORx disabled)
VDDA_1P3 Analog Supplies ¹		1000		mA	
VDIG Supply		410		mA	Tx QEC ² active
VDDA_1P8 Supply		405		mA	Full-scale CW ³
		80		mA	Tx RF attenuation = 0 dB,
VDD_IF Supply		8		mA	Tx RF attenuation = 15 dB
VDDA_3P3 Supply		1		mA	No auxiliary DACs or auxiliary ADCs enabled; if enabled, the auxiliary ADC adds 2.7 mA, and each auxiliary ADC adds 1.5 mA
VDDA_SER, VDDA_DES, JESD_VTT_DES Supplies		375		mA	
Total Power Dissipation					Typical supply voltages, Tx QEC ² active
		3.70		W	Tx RF attenuation = 0 dB
		3.11		W	Tx RF attenuation = 15 dB
POSITIVE SUPPLY CURRENT (FDD MODE), 2× Rx, 2× Tx, ORx ACTIVE					100 MHz Rx BW, 122.88 MSPS data rate; 200 MHz Tx BW, 245.76 MSPS data rate; 200 MHz ORx BW, 245.76 MSPS data rate
VDDA_1P3 Analog Supplies ¹		1700		mA	
VDIG Supply		1080		mA	Tx QEC ² active
VDDA_1P8 Supply		405		mA	Full-scale CW ³
		80		mA	Tx RF attenuation = 0 dB
VDD_IF Supply		8		mA	Tx RF attenuation = 15 dB
VDDA_3P3 Supply		2		mA	No auxiliary DACs or auxiliary ADCs enabled; if enabled, the auxiliary ADC adds 2.7 mA, and each auxiliary ADC adds 1.5 mA
VDDA_SER, VDDA_DES, JESD_VTT_DES Supplies		375		mA	
Total Power Dissipation					Typical supply voltages, Tx QEC ² active
		4.86		W	Tx RF attenuation = 0 dB
		4.27		W	Tx RF attenuation = 15 dB
MAXIMUM OPERATING JUNCTION TEMPERATURE			110	°C	Device designed for 10-year lifetime when operating at maximum junction temperature

¹ VDDA_1P3 refers to all analog 1.3 V supplies including the following: VDDA_BB, VDDA_CLKSYNTH, VDDA_TXLO, VDDA_RXRF, VDDA_RXSYNTH, VDDA_RXVCO, VDDA_RXTX, VDDA_TXSYNTH, VDDA_TXVCO, VDDA_CALPLL, VDDA_SNRXSYNTH, VDDA_SNRXVCO, VDDA_CLK, and VDDA_RXLO.

² QEC is the system for minimizing quadrature images of a desired signal.

³ Continuous wave (CW) is a single frequency signal.

TIMING SPECIFICATIONS

Table 3.

Parameter	Symbol	Min	Typ	Max	Unit	Test Conditions/Comments
SERIAL PERIPHERAL INTERFACE (SPI) TIMING						
SCLK Period	t _{CP}	20			ns	
SCLK Pulse Width	t _{MP}	10			ns	
CSB Setup to First SCLK Rising Edge	t _{SC}	3			ns	
Last SCLK Falling Edge to CSB Hold	t _{HC}	0			ns	
SDIO Data Input Setup to SCLK	t _S	2			ns	
SDIO Data Input Hold to SCLK	t _H	0			ns	
SCLK Falling Edge to Output Data Delay (3- or 4-Wire Mode)	t _{CO}	3		8	ns	
Bus Turnaround Time After Baseband Processor (BBP) Drives Last Address Bit	t _{HZM}	t _H		t _{CO}	ns	
Bus Turnaround Time After AD9371 Drives Last Address Bit	t _{HZS}	0		t _{CO}	ns	
DIGITAL TIMING						
TXx_ENABLE Pulse Width		10			µs	
RXx_ENABLE Pulse Width		10			µs	

JESD204B DATA OUTPUT TIMING		UI	162.76	1627.6	ps	
Unit Interval	UI	162.76	1627.6	ps		
Data Rate per Channel (Nonreturn to Zero (NRZ))		614.4	6144	Mbps		
Rise Time	t_R	24	35	ps		20% to 80% in 100 Ω load
Fall Time	t_F	24	35	ps		20% to 80% in 100 Ω load
Output Common-Mode Voltage	V_{CM}	0	1.8	V		AC-coupled
Termination Voltage (V_{TT}) = 1.2 V		735	1135	mV		DC-coupled
Differential Output Voltage	V_{DIFF}	360	466	770	mV	
Short-Circuit Current	I_{DSHORT}	-100	+100	mA		
Differential Termination Impedance	Z_{RDIFF}	80	100	120	Ω	
Total Jitter			17	48.8	ps	Bit error rate (BER) = 10^{-15}
Uncorrelated Bounded High Probability Jitter	UBHPJ		1.2	24.4	ps	
Duty-Cycle Distortion	DCD		3	8.1	ps	
SYSREF_IN Signal Setup Time to DEV_CLK_IN Signal	t_S	2.5			ns	See Figure 2 and Figure 3
SYSREF_IN Signal Hold Time to DEV_CLK_IN Signal	t_H	-1.5			ns	See Figure 2 and Figure 3
JESD204B DATA INPUT TIMING		UI	162.76	1627.6	ps	
Unit Interval	UI	162.76	1627.6	ps		
Data Rate per Channel (NRZ)		614.4	6144	Mbps		
Input Common-Mode Voltage	V_{CM}	0.05	1.85	V		AC-coupled
V_{TT} = 1.2 V		720	1200	mV		DC-coupled
Differential Input Voltage	V_{DIFF}	125	750	mV		
V_{TT} Source Impedance	Z_{TT}		1.2	30	Ω	
Differential Termination Impedance	Z_{RDIFF}	80	106	120	Ω	
V_{TT}						
AC-Coupled			1.27	1.33	V	
DC-Coupled			1.14	1.26	V	

Timing Diagrams

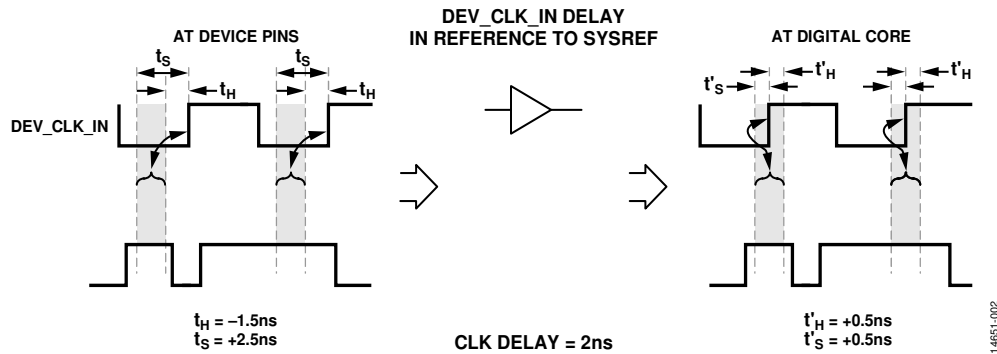

Figure 2. SYSREF_IN Signal Setup and Hold Timing

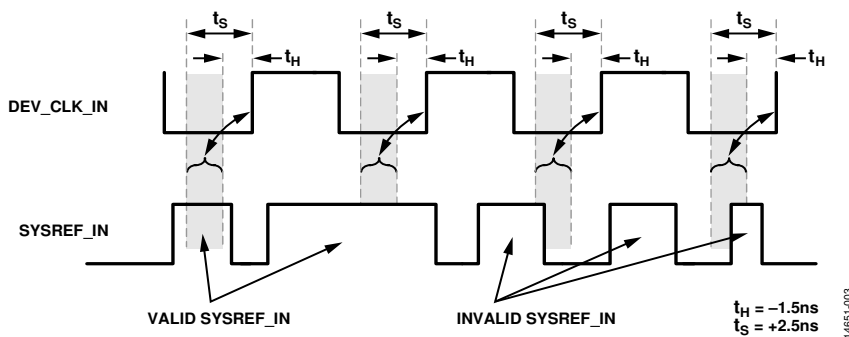

Figure 3. SYSREF_IN Signal Setup and Hold Timing Examples Relative to DEV_CLK_IN Signal

ABSOLUTE MAXIMUM RATINGS

Table 4.

Parameter	Rating
VDDA_1P3 ¹ to VSSA	−0.3 V to +1.4 V
VDDA_SER, VDDA_DES, and JESD_VTT_DES to VSSA	−0.3 V to +1.4 V
VDIG to VSSD	−0.3 V to +1.4 V
VDDA_1P8 to VSSA	−0.3 V to +2.0 V
VDD_IF to VSSA	−0.3 V to +3.0 V
VDDA_3P3 to VSSA	−0.3 V to +3.9 V
Logic Inputs and Outputs to VSSD	−0.3 V to VDD_IF + 0.3 V
JESD204B Logic Outputs to VSSA	−0.3 V to VDDA_SER
JESD204B Logic Inputs to VSSA	−0.3 V to VDDA_DES
Input Current to Any Pin Except Supplies	±10 mA
Maximum Input Power into RF Ports (Excluding Sniffer Receiver Inputs)	23 dBm (peak)
Maximum Input Power into SNRXA±, SNRXB±, and SNRXC±	2 dBm (peak)
Maximum Junction Temperature (T _{J,MAX})	110°C
Operating Temperature Range	−40°C to +85°C
Storage Temperature Range	−65°C to +150°C

¹ VDDA_1P3 refers to all analog 1.3 V supplies: VDDA_BB, VDDA_CLKSYNTH, VDDA_TXLO, VDDA_RXSYNTH, VDDA_RXVCO, VDDA_RXTX, VDDA_RXRF, VDDA_TXSYNTH, VDDA_TXVCO, VDDA_CALPLL, VDDA_SNRXSYNTH, VDDA_SNRXVCO, VDDA_CLK, and VDDA_RXLO.

Stresses at or above those listed under Absolute Maximum Ratings may cause permanent damage to the product. This is a stress rating only; functional operation of the product at these or any other conditions above those indicated in the operational section of this specification is not implied. Operation beyond the maximum operating conditions for extended periods may affect product reliability.

REFLOW PROFILE

The AD9371 reflow profile is in accordance with the JEDEC JESD20 criteria for Pb-free devices. The maximum reflow temperature is 260°C.

THERMAL RESISTANCE

Thermal performance is directly linked to PCB design and operating environment. Careful attention to PCB thermal design is required.

Table 5. Thermal Resistance

Package	Airflow Velocity ¹ (m/sec)	$\theta_{JA}^{2,3}$ (°C/W)	$\theta_{JC}^{2,4}$ (°C/W)
BC-196-12 JEDEC ⁵	0.0	20.5	0.05
	1.0	18.5	N/A ⁶
	2.5	17.2	N/A ⁶
10-Layer PCB	0.0	14.1	0.05
	1.0	12.4	N/A ⁶
	2.5	11.6	N/A ⁶

¹ Power dissipation is 3.0 W for all test cases.

² Per JEDEC JESD51-7 for JEDEC JESD51-5 2S2P test board.

³ Per JEDEC JESD51-2 (still air) or JEDEC JESD51-6 (moving air).

⁴ Per MIL-STD 883, Method 1012.1.

⁵ JEDEC entries refer to the JEDEC JESD51-9 (high K thermal test board).

⁶ N/A means not applicable.

ESD CAUTION



ESD (electrostatic discharge) sensitive device.

Charged devices and circuit boards can discharge without detection. Although this product features patented or proprietary protection circuitry, damage may occur on devices subjected to high energy ESD. Therefore, proper ESD precautions should be taken to avoid performance degradation or loss of functionality.

PIN CONFIGURATION AND FUNCTION DESCRIPTIONS

AD9371
TOP VIEW
(Not to Scale)

	1	2	3	4	5	6	7	8	9	10	11	12	13	14
A	VSSA	ORX2+	ORX2-	VSSA	RX2+	RX2-	VSSA	VSSA	RX1+	RX1-	VSSA	ORX1+	ORX1-	VSSA
B	VDDA_RXRF	VSSA	VSSA	VSSA	VSSA	VSSA	RX_EXTLO-	RX_EXTLO+	VSSA	VSSA	VSSA	VSSA	VSSA	VDDA_3P3
C	GPIO_3P3_0	GPIO_3P3_1	VSNRX VCO_LDO	VDDA SNRXVCO	VSSA	VDDA_RXLO	VDDA_RXVCO	VRX VCO_LDO	VSSA	VSSA	AUXADC_1	AUXADC_2	GPIO_3P3_9	RBIAS
D	GPIO_3P3_3	SNRXC-	SNRXB-	SNRXA-	GPIO_3P3_5	VSSA	VSSA	VSSA	VSSA	VDDA_1P8	AUXADC_3	GPIO_3P3_7	GPIO_3P3_8	GPIO_3P3_10
E	GPIO_3P3_4	SNRXC+	SNRXB+	SNRXA+	VDDA_BB	VSSA	DEV_CLK_IN+	DEV_CLK_IN-	VSSA	VSSA	TX_EXTLO-	TX_EXTLO+	AUXADC_0	GPIO_3P3_6
F	GPIO_3P3_2	VDDA_RXTX	VSSA	VSSA	VSSA	VSSA	VSSA	VSSA	VSSA	VSSA	VDDA_TXVCO	VDDA_TXLO	VTX VCO_LDO	GPIO_3P3_11
G	VSSA	VSSA	VSSA	VDDA_CALPLL	VSSA	VDDA_CLKSYNTH	VDDA_SNRXSYNTH	VDDA_TXSYNTH	VDDA_RXSYNTH	VSSA	VSSA	VSSA	VSSA	VSSA
H	TX2-	VSSA	VSSA	VSSA	VSSA	VSSA	VSSA	VSSA	VSSA	VSSA	GPIO_12	GPIO_11	VSSA	TX1+
J	TX2+	VSSA	GPIO_18	RESET	GP INTERRUPT	TEST	GPIO_2	GPIO_1	SDIO	SDO	GPIO_13	GPIO_10	VSSA	TX1-
K	VSSA	VSSA	SYSREF_IN+	SYSREF_IN-	GPIO_5	GPIO_4	GPIO_3	GPIO_0	SCLK	CSB	GPIO_14	GPIO_9	VSSA	VSSA
L	VSSA	VSSA	SYNCINB1-	SYNCINB1+	GPIO_6	GPIO_7	VSSD	VDIG	VDIG	VSSD	GPIO_15	GPIO_8	VSSA	VSSA
M	VCLK VCO_LDO	VSSA	SYNCINB0-	SYNCINB0+	RX1 ENABLE	TX1 ENABLE	RX2 ENABLE	TX2 ENABLE	VSSA	GPIO_17	GPIO_16	VDD_IF	SYNCOUTB0+	SYNCOUTB0-
N	VDDA_CLK	VSSA	SERDOUT3-	SERDOUT3+	SERDOUT2-	SERDOUT2+	VSSA	VDDA_SER	VDDA_DES	SERDIN2-	SERDIN2+	SERDIN3-	SERDIN3+	VSSA
P	VSSA	VSSA	VSSA	SERDOUT1-	SERDOUT1+	SERDOUT0-	SERDOUT0+	VDDA_SER	JESD_VTT_DES	VSSA	SERDIN0-	SERDIN0+	SERDIN1-	SERDIN1+

ANALOG INPUT/OUTPUT
 DIGITAL INPUT/OUTPUT
 DC POWER
 GROUND

Figure 4. Pin Configuration

Table 6. Pin Function Descriptions

Pin No.	Type ¹	Mnemonic	Description
A1, A4, A7, A8, A11, A14, B2 to B6, B9 to B13, C5, C9, C10, D6 to D9, E6, E9, E10, F3 to F10, G1 to G3, G5, G10 to G14, H2 to H10, H13, J2, J13, K1, K2, K13, K14, L1, L2, L13, L14, M2, M9, N2, N7, N14, P1, P2, P3, P10	I	VSSA	Analog ground.
A2, A3	I	ORX2+, ORX2-	Differential Input for Observation Receiver 2. Do not connect if these pins are unused.
A5, A6	I	RX2+, RX2-	Differential Input for Receiver 2. Do not connect if these pins are unused.
A9, A10	I	RX1+, RX1-	Differential Input for Receiver 1. Do not connect if these pins are unused.

Pin No.	Type ¹	Mnemonic	Description
A12, A13	I	ORX1+, ORX1-	Differential Input for Observation Receiver 1. Do not connect if these pins are unused.
B1	I	VDDA_RXRF	1.3 V Supply Input.
B7, B8	I/O	RX_EXTLO-, RX_EXTLO+	Differential Rx External LO Input/Output. If used for external LO, the input frequency must be 2× the desired carrier frequency. Do not connect if these pins are unused.
B14	I	VDDA_3P3	Supply Voltage for GPIO_3P3_x.
C1, C2, C13, D1, D5, D12 to D14, E1, E14, F1, F14	I/O	GPIO_3P3_0 to GPIO_3P3_11	General-Purpose Inputs and Outputs Referenced to 3.3 V Supply. See Figure 4 to match the ball location to the GPIO_3P3_x signal name. Some GPIO_3P3_x pins can also function as auxiliary DAC outputs.
C3	O	VSNRX_VCO_LDO	Sniffer VCO LDO 1.1 V Output. Bypass this pin with a 1 μF capacitor.
C4	I	VDDA_SNRXVCO	1.3 V Supply Input for Sniffer VCO Low Dropout (LDO) Regulator.
C6	I	VDDA_RXLO	1.3 V Supply for the Rx Synthesizer LO Generator. This pin is sensitive to aggressors.
C7	I	VDDA_RXVCO	1.3 V Supply Input for Receiver VCO LDO Regulator.
C8	O	VRX_VCO_LDO	Receiver VCO LDO 1.1 V Output. Bypass this pin with a 1 μF capacitor.
C11	I	AUXADC_1	Auxiliary ADC 1 Input Pin.
C12	I	AUXADC_2	Auxiliary ADC 2 Input Pin.
C14	N/A	RBIAS	Bias Resistor Connection. This pin generates an internal current based on an external 1% resistor. Connect a 14.3 kΩ resistor between this pin and ground (VSSA).
D2, E2	I	SNRXC-, SNRXC+	Differential Input for Sniffer Receiver Input C. If these pins are unused, connect to VSSA with a short or with a 1 kΩ resistor.
D3, E3	I	SNRXB-, SNRXB+	Differential Input for Sniffer Receiver Input B. If these pins are unused, connect to VSSA with a short or with a 1 kΩ resistor.
D4, E4	I	SNRXA-, SNRXA+	Differential Input for Sniffer Receiver Input A. If these pins are unused, connect to VSSA with a short or with a 1 kΩ resistor.
D10	I	VDDA_1P8	1.8 V Tx Supply.
D11	I	AUXADC_3	Auxiliary ADC 3 Input Pin.
E5	I	VDDA_BB	1.3 V Supply Input for ADCs, DACs, and Auxiliary ADCs.
E7, E8	I	DEV_CLK_IN+, DEV_CLK_IN-	Device Clock Differential Input.
E11, E12	I/O	TX_EXTLO-, TX_EXTLO+	Differential Tx External LO Input/Output. If these pins are used for the external LO, the input frequency must be 2× the desired carrier frequency. Do not connect if these pins are unused.
E13	I	AUXADC_0	Auxiliary ADC 0 Input Pin.
F2	I	VDDA_RXTX	1.3 V Supply Input for Tx/Rx Baseband Circuits, Transimpedance Amplifier (TIA), Tx Transconductance (G _m), Baseband Filters, and Auxiliary DACs.
F11	I	VDDA_TXVCO	1.3 V Supply Input for Transmitter VCO LDO Regulator.
F12	I	VDDA_TXLO	1.3 V Supply for the Tx Synthesizer LO Generator. This pin is sensitive to aggressors.
F13	O	VTX_VCO_LDO	Transmitter VCO LDO 1.1 V Output. Bypass this pin with a 1 μF capacitor.
G4	I	VDDA_CALPLL	1.3 V Supply Input for Calibration PLL Circuits. Use a separate trace on the PCB back to a common supply point.
G6	I	VDDA_CLKSYNTH	1.3 V Clock Synthesizer Supply Input. This pin is sensitive to aggressors.
G7	I	VDDA_SNRXSYNTH	1.3 V Sniffer Rx Synthesizer Supply Input. This pin is sensitive to aggressors.
G8	I	VDDA_TXSYNTH	1.3 V Tx Synthesizer Supply Input. This pin is sensitive to aggressors.
G9	I	VDDA_RXSYNTH	1.3 V Rx Synthesizer Supply Input. This pin is sensitive to aggressors.

Pin No.	Type ¹	Mnemonic	Description
H1, J1	O	TX2-, TX2+	Differential Output for Transmitter 2.
H11, H12, J3, J7, J8, J11, J12, K5 to K8, K11, K12, L5, L6, L11, L12, M10, M11	I/O	GPIO_0 to GPIO_18	General-Purpose Inputs and Outputs Referenced to VDD_IF. See Figure 4 to match the ball location to the GPIO_x signal name.
H14, J14	O	TX1+, TX1-	Differential Output for Transmitter 1.
J4	I	RESET	Active Low Chip Reset.
J5	O	GP_INTERRUPT	General-Purpose Interrupt Signal.
J6	I	TEST	Test Pin Used for JTAG Boundary Scan. Ground this pin if unused.
J9	I/O	SDIO	Serial Data Input in 4-Wire Mode or Input/Output in 3-Wire Mode.
J10	O	SDO	Serial Data Output.
K3, K4	I	SYSREF_IN+, SYSREF_IN-	LVDS SYSREF Clock Inputs for the JESD204B Interface.
K9	I	SCLK	Serial Data Bus Clock.
K10	I	CSB	Serial Data Bus Chip Select. Active low.
L3, L4	I	SYNCINB1-, SYNCINB1+	LVDS Sync Signal Associated with ORx/Sniffer Channel Data on the JESD204B Interface. Alternatively, these pins can be set to a CMOS input using SYNCINB1+ as the input and connecting SYNCINB1- with a 1 kΩ resistor to GND.
L7, L10	I	VSSD	Digital Ground.
L8, L9	I	VDIG	1.3 V Digital Core Supply. Use a separate trace on the PCB back to a common supply point.
M1	O	VCLK_VCO_LDO	Clock VCO LDO 1.1 V Output. Bypass this pin with a 1 μF capacitor.
M3, M4	I	SYNCINB0-, SYNCINB0+	LVDS Sync Signal Associated with Rx Channel Data on the JESD204B Interface. Alternatively, these pins can be set to a CMOS input using SYNCINB0+ as the input and connecting SYNCINB0- with a 1 kΩ resistor to GND.
M5	I	RX1_ENABLE	Enables Rx Channel 1 Signal Path.
M6	I	TX1_ENABLE	Enables Tx Channel 1 Signal Path.
M7	I	RX2_ENABLE	Enables Rx Channel 2 Signal Path.
M8	I	TX2_ENABLE	Enables Tx Channel 2 Signal Path.
M12	I	VDD_IF	CMOS/LVDS Interface Supply.
M13, M14	O	SYNCOUTB0+, SYNCOUTB0-	LVDS Sync Signal Associated with Transmitter Channel Data on the JESD Interface. Alternatively, these pins can be set to a CMOS output using SYNCOUTB0+ as the output while leaving SYNCOUTB0- floating.
N1	I	VDDA_CLK	1.3 V Clock Supply Input.
N3, N4	O	SERDOUT3-, SERDOUT3+	RF Current Mode Logic (CML) Differential Output 3. This JESD204B lane can be used by the receiver data or by the sniffer/observation receiver data.
N5, N6	O	SERDOUT2-, SERDOUT2+	RF CML Differential Output 2. This JESD204B lane can be used by the receiver data or by the sniffer/observation receiver data.
N8, P8	I	VDDA_SER	JESD204B 1.3 V Serializer Supply Input.
N9	I	VDDA_DES	JESD204B 1.3 V Deserializer Supply Input.
N10, N11	I	SERDIN2-, SERDIN2+	RF CML Differential Input 2.
N12, N13	I	SERDIN3-, SERDIN3+	RF CML Differential Input 3.
P4, P5	O	SERDOUT1-, SERDOUT1+	RF CML Differential Output 1. This JESD204B lane can be used by receiver data or by sniffer/observation receiver data.
P6, P7	O	SERDOUT0-, SERDOUT0+	RF CML Differential Output 0. This JESD204B lane can be used by receiver data or by sniffer/observation receiver data.
P9	I	JESD_VTT_DES	JESD204B Deserializer Termination Supply Input.
P11, P12	I	SERDIN0-, SERDIN0+	RF CML Differential Input 0.
P13, P14	I	SERDIN1-, SERDIN1+	RF CML Differential Input 1.

¹ I is input, O is output, I/O is input/output, and N/A is not applicable.

TYPICAL PERFORMANCE CHARACTERISTICS

700 MHz BAND

Temperature settings refer to the die temperature. The die temperature is 40°C for single trace plots.

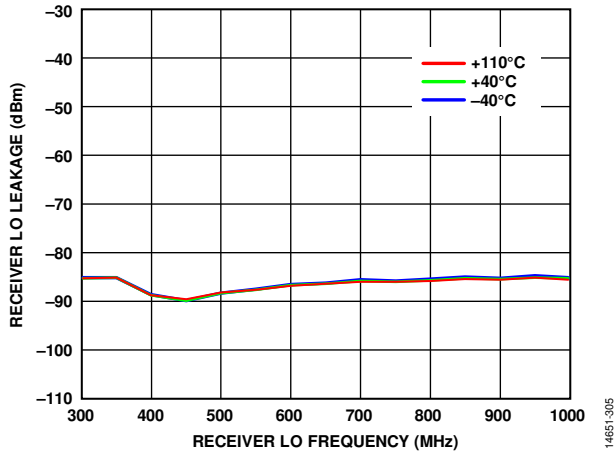

Figure 5. Receiver Local Oscillator (LO) Leakage vs. Receiver LO Frequency, 0 dB Receiver Attenuation, 20 MHz RF Bandwidth, 30.72 MSPS Sample Rate

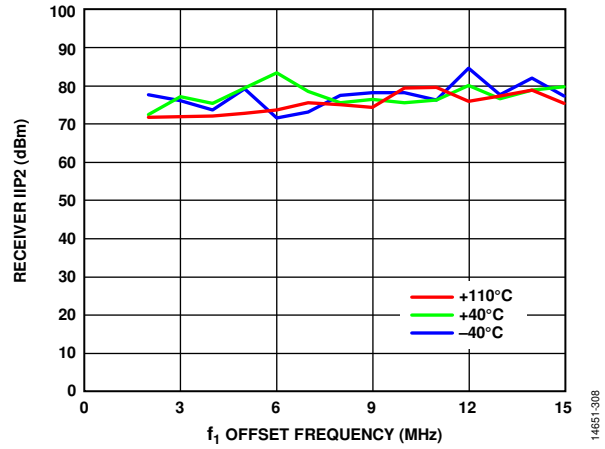

Figure 8. Receiver IIP2 vs. f_1 Offset Frequency, 900 MHz LO, 0 dB Attenuation, 20 MHz RF Bandwidth, $f_2 = f_1 + 1$ MHz, 30.72 MSPS Sample Rate

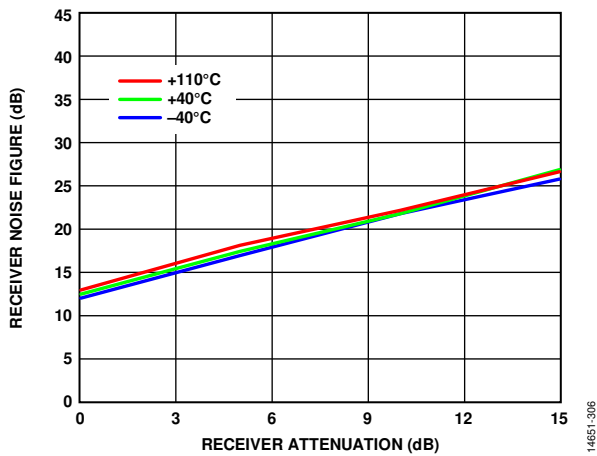

Figure 6. Receiver Noise Figure vs. Receiver Attenuation, 700 MHz LO, 20 MHz Bandwidth, 30.72 MSPS Sample Rate, 20 MHz Integration Bandwidth (Includes 1 dB Matching Circuit Loss)

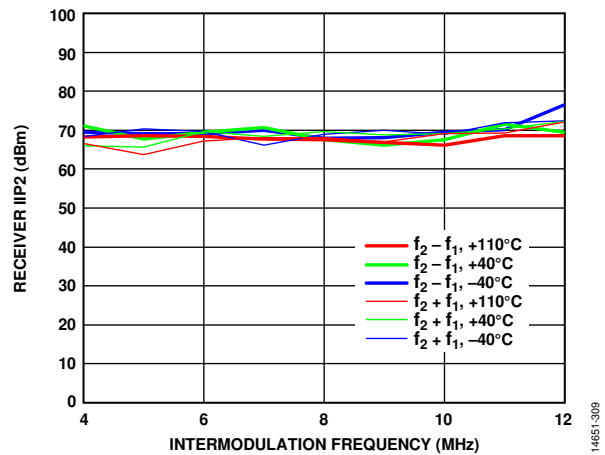

Figure 9. Receiver IIP2 vs. Intermodulation Frequency, 900 MHz LO, 0 dB Attenuation, 20 MHz RF Bandwidth, 30.72 MSPS Sample Rate

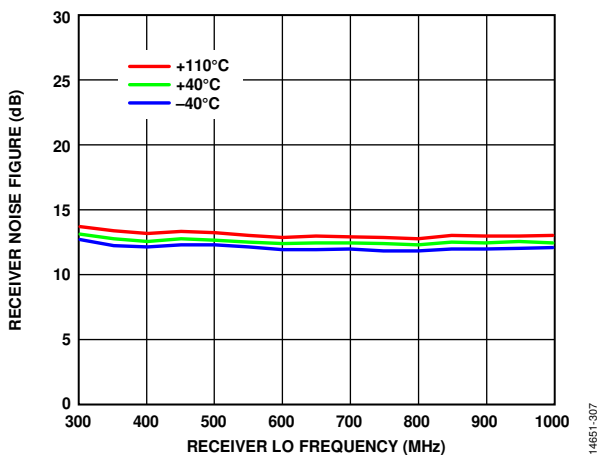

Figure 7. Receiver Noise Figure vs. Receiver LO Frequency, 0 dB Receiver Attenuation, 20 MHz RF Bandwidth, 30.72 MSPS Sample Rate, 20 MHz Integration Bandwidth (Includes 1 dB Matching Circuit Loss)

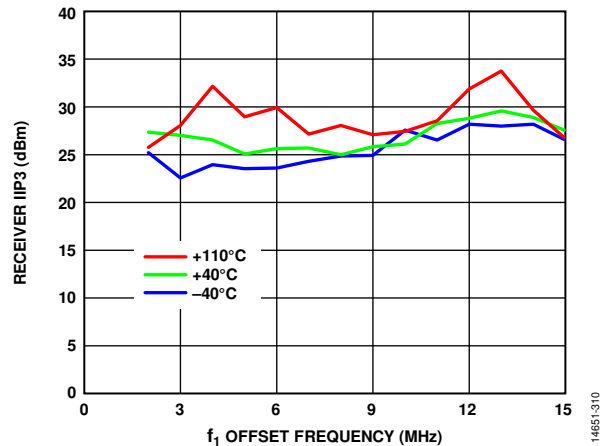

Figure 10. Receiver IIP3 vs. F_1 Offset Frequency, 900 MHz LO, 0 dB Attenuation, 20 MHz RF Bandwidth, $f_2 = 2f_1 + 1$ MHz, 30.72 MSPS Sample Rate

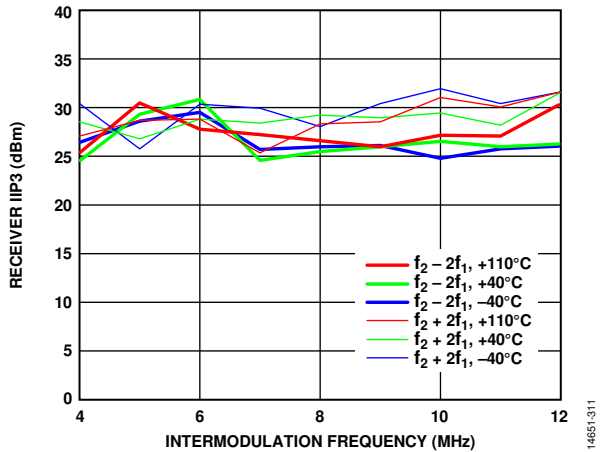

Figure 11. Receiver IIP3 vs. Intermodulation Frequency, 900 MHz LO, 0 dB Attenuation, 20 MHz RF Bandwidth, 30.72 MSPS Sample Rate

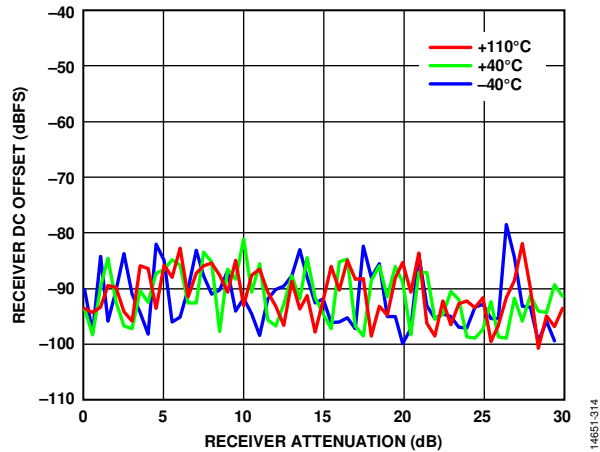

Figure 14. Receiver DC Offset vs. Receiver Attenuation, 800 MHz LO, 20 MHz RF Bandwidth, 30.72 MSPS Sample Rate

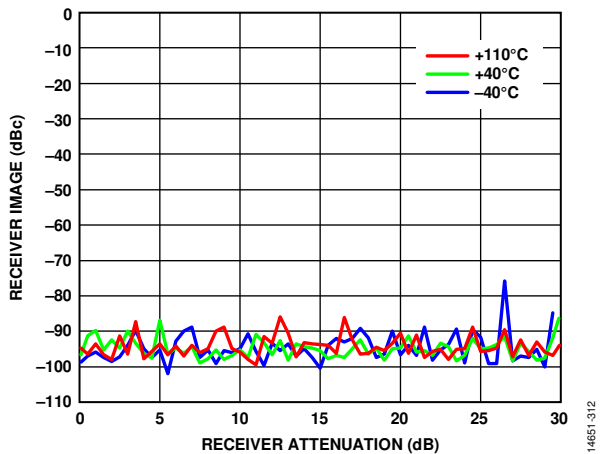

Figure 12. Receiver Image vs. Receiver Attenuation, 800 MHz LO, Continuous Wave (CW) Signal 3 MHz Offset, 20 MHz RF Bandwidth, Background Tracking Calibration (BTC) Active, 30.72 MSPS Sample Rate

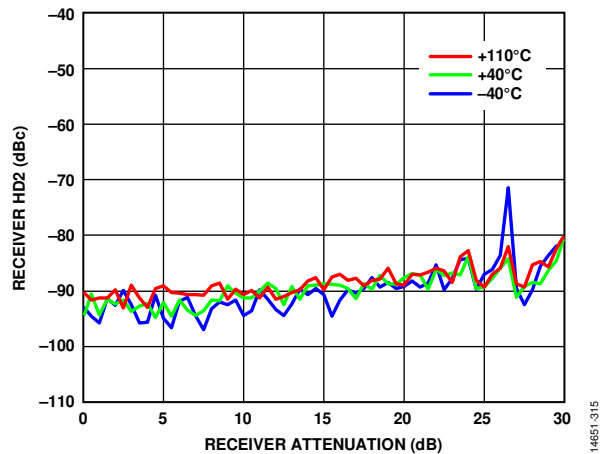

Figure 15. Receiver HD2 vs. Receiver Attenuation, 800 MHz LO, CW Signal 3 MHz Offset, -20 dBm at 0 dB Attenuation, Input Power Increasing Decibel with Attenuation, 20 MHz RF Bandwidth, 30.72 MSPS Sample Rate

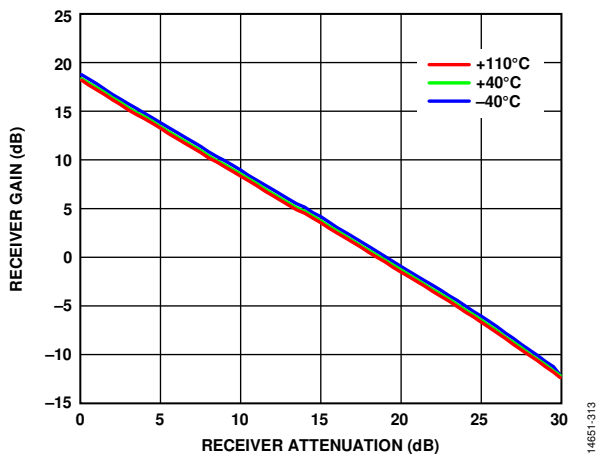

Figure 13. Receiver Gain vs. Receiver Attenuation, 800 MHz LO, CW Signal 3 MHz Offset, 20 MHz RF Bandwidth, 30.72 MSPS Sample Rate

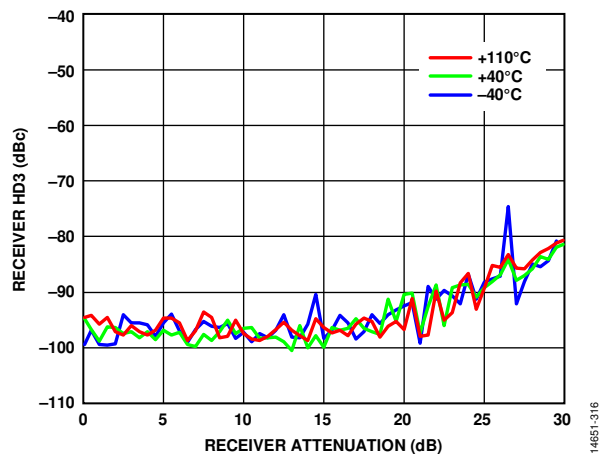

Figure 16. Receiver HD3 vs. Receiver Attenuation, 800 MHz LO, CW Signal 3 MHz Offset, -20 dBm at 0 dB Attenuation, Input Power Increasing Decibel with Attenuation, 20 MHz RF Bandwidth, 30.72 MSPS Sample Rate

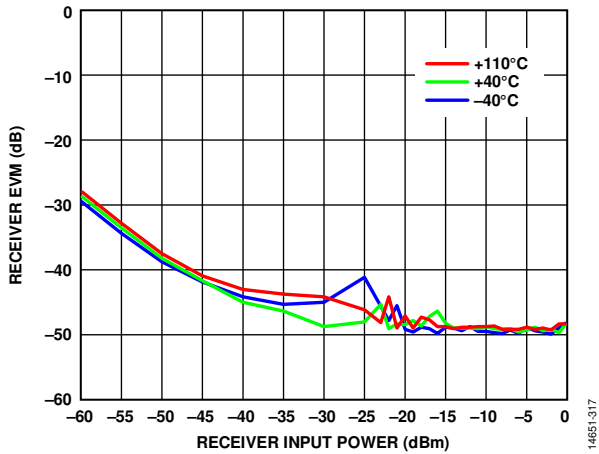

Figure 17. Receiver Error Vector Magnitude (EVM) vs. Receiver Input Power, 900 MHz LO, 20 MHz RF Bandwidth, LTE 20 MHz Uplink Centered at DC, BTC Active, 30.72 MSPS Sample Rate

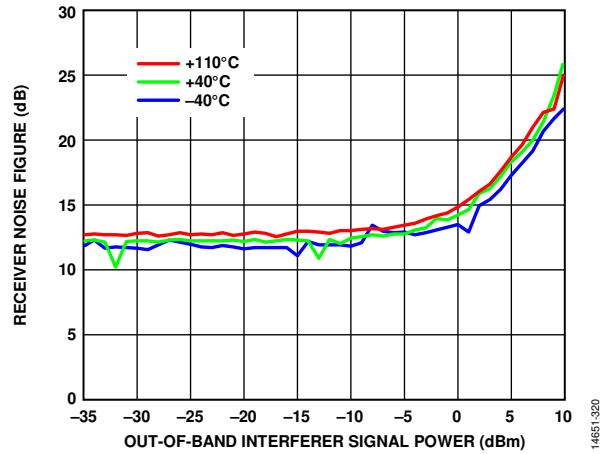

Figure 20. Receiver Noise Figure vs. Out-of-Band Interferer Signal Power, 703 MHz LO, 901 MHz CW Interferer, NF Integrated Over 7 MHz to 10 MHz, 20 MHz RF Bandwidth

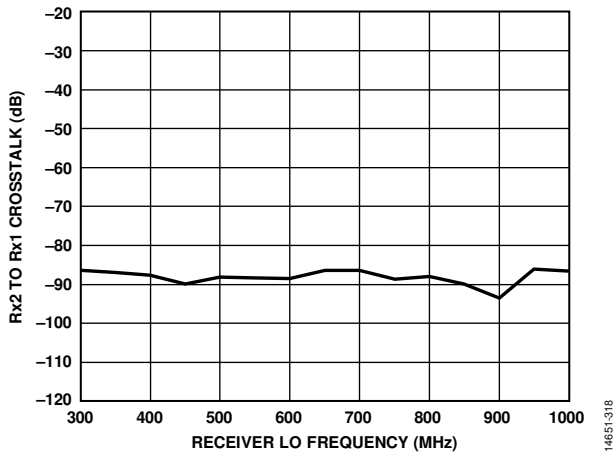

Figure 18. Rx2 to Rx1 Crosstalk vs. Receiver LO Frequency, 100 MHz RF Bandwidth, CW Tone 3 MHz Offset from LO

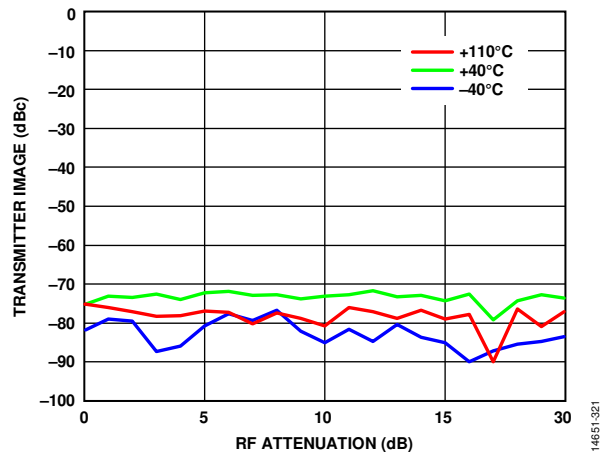

Figure 21. Transmitter Image vs. RF Attenuation, 20 MHz RF Bandwidth, 900 MHz LO, Transmitter Quadrature Error Correction (QEC) Tracking Run with Two 20 MHz LTE Downlink Carriers, Then Image Measured with CW 10 MHz Offset from LO, 3 dB Digital Backoff, 122.88 MSPS Sample Rate

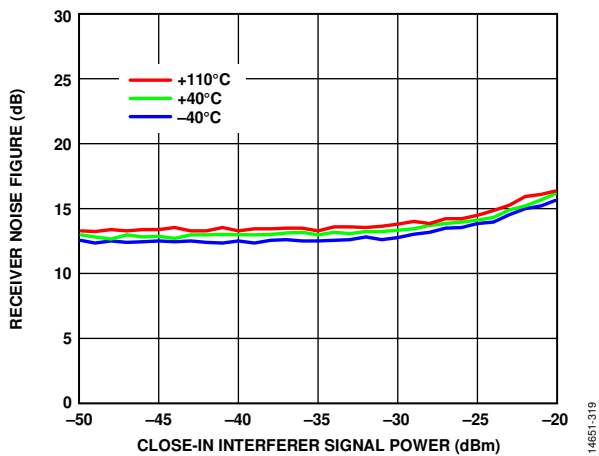

Figure 19. Receiver Noise Figure vs. Close-In Interferer Signal Power, 703 MHz LO, 709 MHz CW Interferer, NF Integrated over 7 MHz to 10 MHz, 20 MHz RF Bandwidth

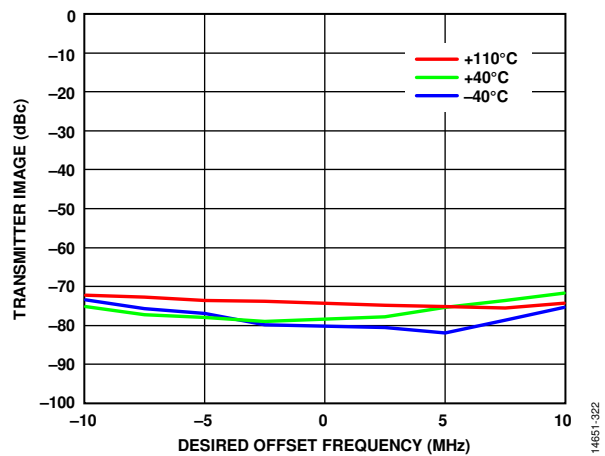

Figure 22. Transmitter Image vs. Desired Offset Frequency, 20 MHz RF Bandwidth, 900 MHz LO, 0 dB RF Attenuation, Transmitter QEC Tracking Run with Two 20 MHz LTE Downlink Carriers, Then Image Measured with CW Signal, 3 dB Digital Backoff, 122.88 MSPS Sample Rate

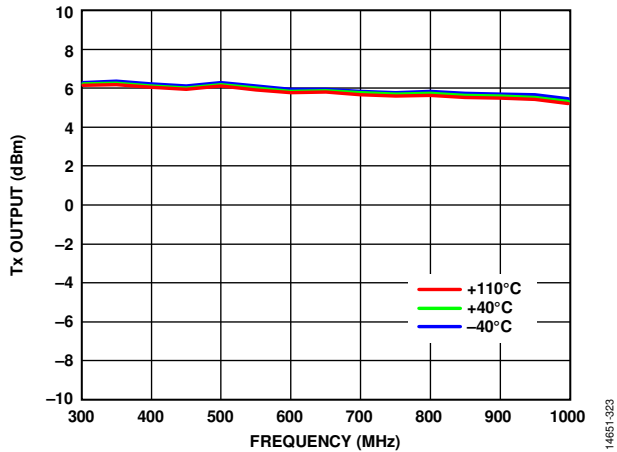

Figure 23. Tx Output Power, Transmitter QEC, and External LO Leakage Tracking Active, 10 MHz CW Offset Signal, 1 MHz Resolution Bandwidth, 122.88 MSPS Sample Rate

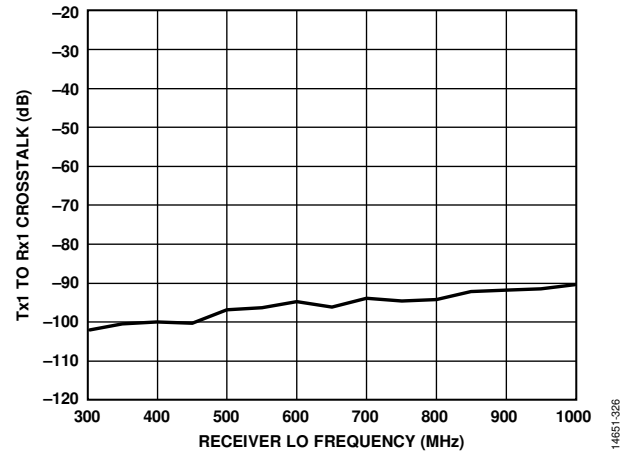

Figure 26. Tx1 to Rx1 Crosstalk vs. Receiver LO Frequency, 20 MHz Receiver RF Bandwidth, 20 MHz Transmitter RF Bandwidth, CW Signal 3 MHz Offset from LO

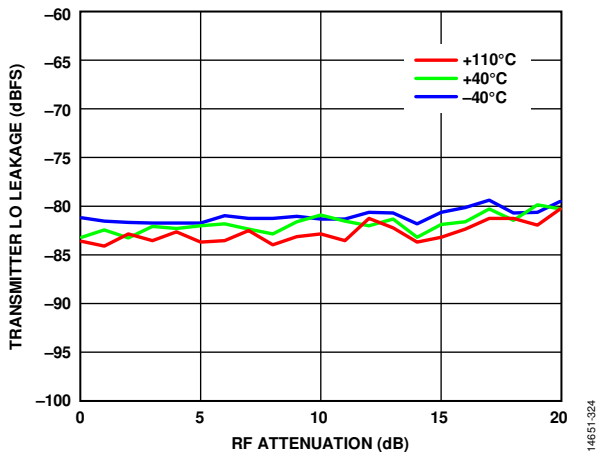

Figure 24. Transmitter LO Leakage vs. RF Attenuation, 900 MHz LO, Transmitter QEC and External LO Leakage Tracking Active, CW Signal 5 MHz Offset from LO, 6 dB Digital Backoff, 1 MHz Measurement Bandwidth (If Input Power to ORx Channel Is Not Held Constant, Performance Degrades As Shown in This Plot)

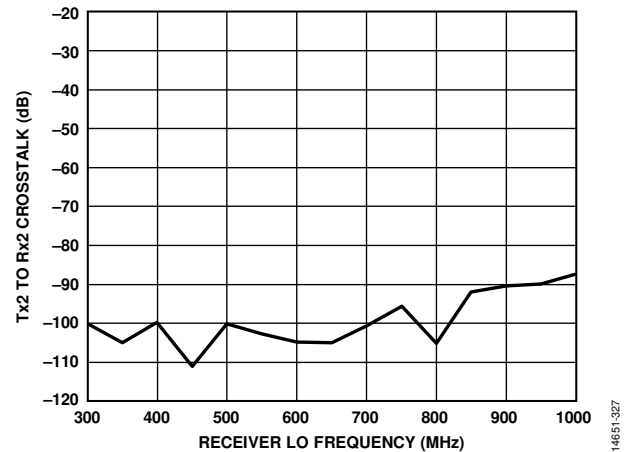

Figure 27. Tx2 to Rx2 Crosstalk vs. Receiver LO Frequency, 20 MHz Receiver RF Bandwidth, 20 MHz Transmitter RF Bandwidth, CW Signal 3 MHz Offset from LO

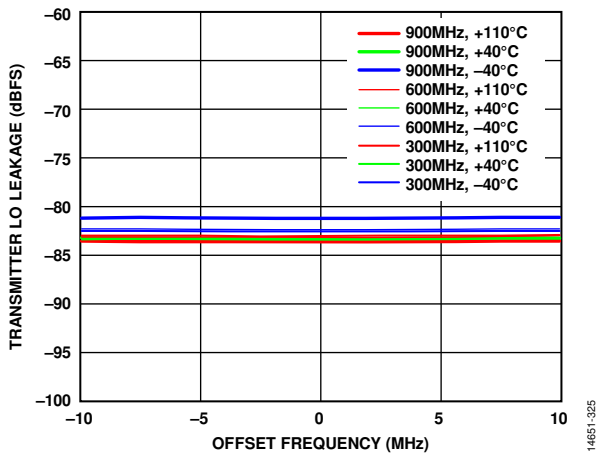

Figure 25. Transmitter LO Leakage vs. Offset Frequency, Transmitter QEC and External LO Leakage Tracking Active, 5 dB Digital Backoff, 1 MHz Measurement Bandwidth

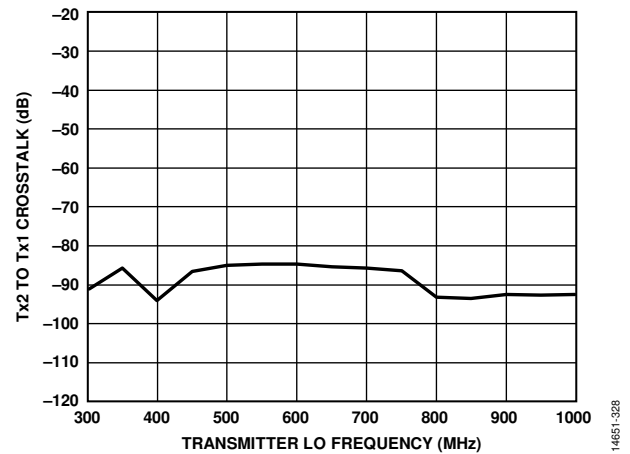

Figure 28. Tx2 to Tx1 Crosstalk vs. Transmitter LO Frequency, 20 MHz RF Bandwidth, CW Signal 3 MHz Offset from LO

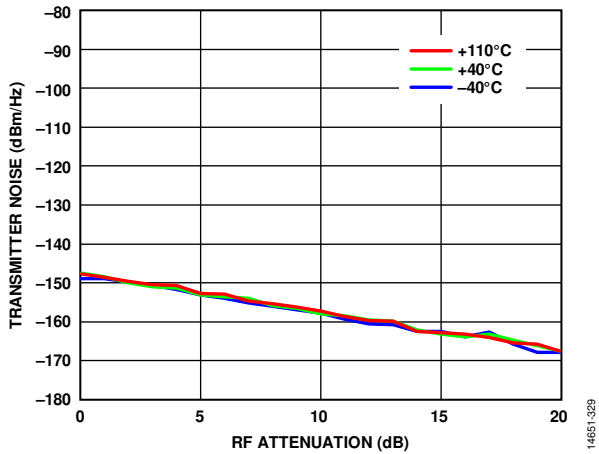

Figure 29. Transmitter Noise vs. RF Attenuation, 800 MHz LO, 20 MHz Offset Frequency

14651-329

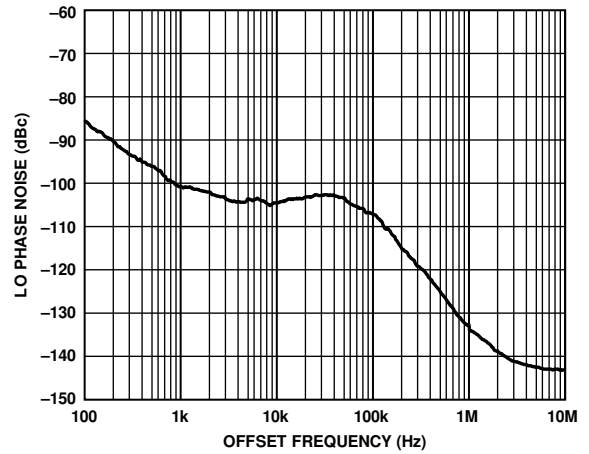

Figure 32. LO Phase Noise vs. Offset Frequency, 3 dB Digital Backoff, 710 MHz LO

14651-332

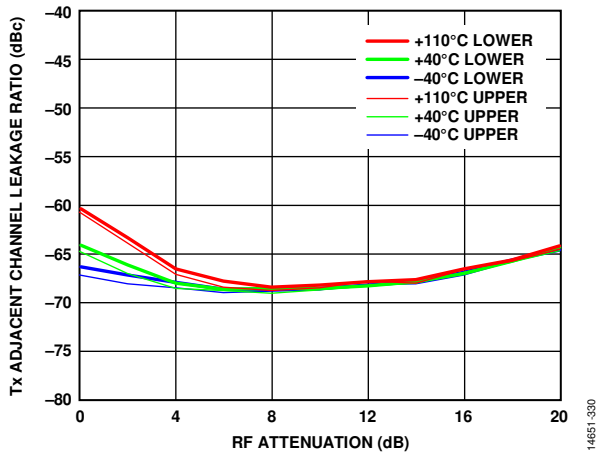

Figure 30. Tx Adjacent Channel Leakage Ratio vs. RF Attenuation, 900 MHz LO, 20 MHz RF Bandwidth, Four-Carrier W-CDMA Desired Signal, Transmitter QEC and LO Leakage Tracking Active

14651-330

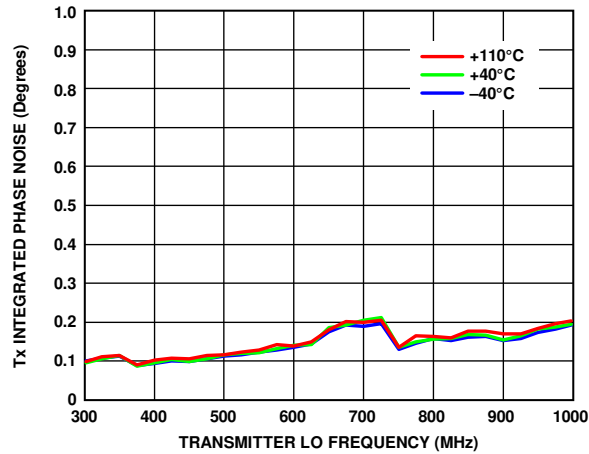

Figure 33. Tx Integrated Phase Noise vs. Transmitter LO Frequency, 20 MHz RF Bandwidth, CW 20 MHz Offset from LO, 3 dB Digital Backoff

14651-333

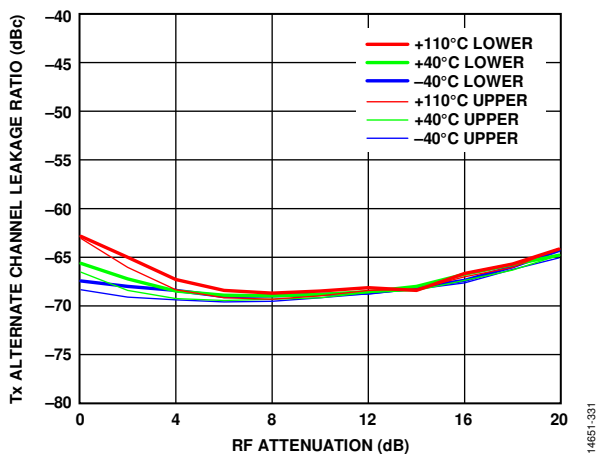

Figure 31. Tx Alternate Channel Leakage Ratio vs. RF Attenuation, 900 MHz LO, 20 MHz RF Bandwidth, Four-Carrier W-CDMA Desired Signal, 2 dB Digital Backoff, Transmitter QEC and LO Leakage Tracking Active

14651-331

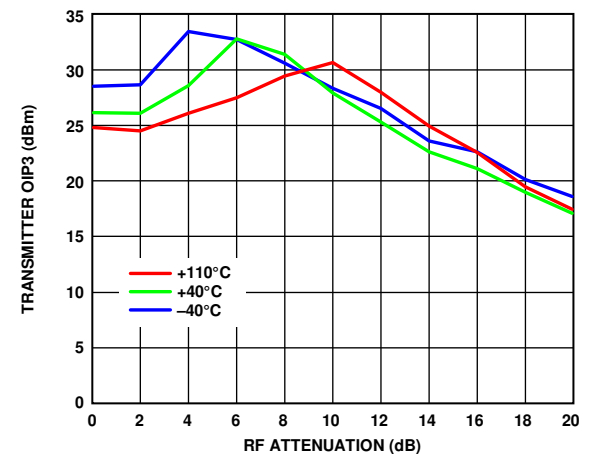

Figure 34. Transmitter OIP3 vs. RF Attenuation, 800 MHz LO, 20 MHz RF Bandwidth, $f_1 = 10$ MHz, $f_2 = 11$ MHz, 3 dB Digital Backoff, 122.88 MSPS Sample Rate

14651-334

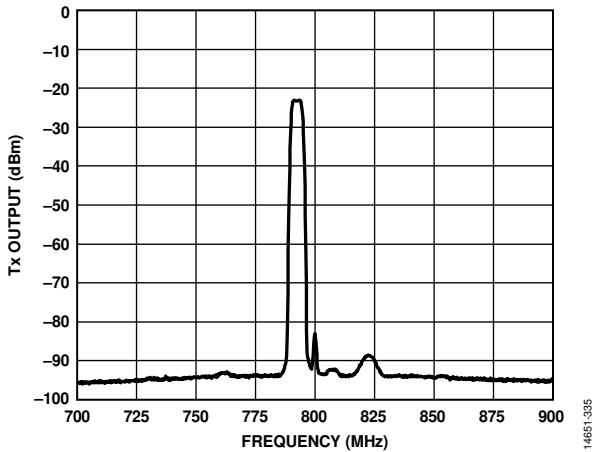

Figure 35. Tx Output Power Spectrum, 2 dB Digital and 3 dB RF Backoff, 20 MHz RF Bandwidth, Transmitter QEC, and Internal LO Leakage Active, LTE 10 MHz Signal, 800 MHz LO, 1 MHz Resolution Bandwidth, 122.88 MSPS Sample Rate, Test Equipment Noise Floor De-Embedded

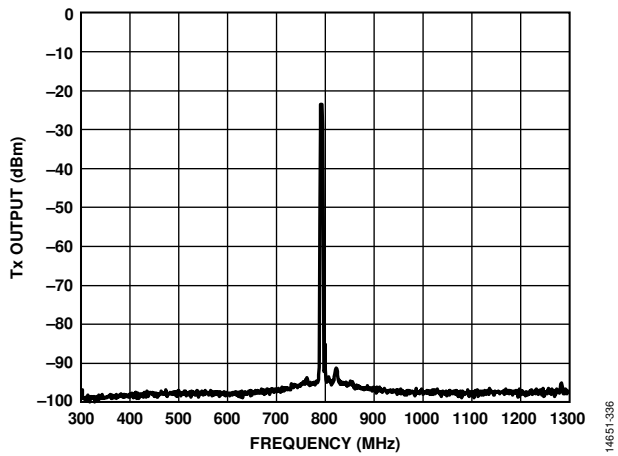

Figure 36. Tx Output Power Spectrum, 2 dB Digital and 3 dB RF Backoff, 20 MHz RF Bandwidth, Transmitter QEC, and Internal LO Leakage Active, LTE 10 MHz Signal, 800 MHz LO, 1 MHz Resolution Bandwidth, 122.88 MSPS Sample Rate, Test Equipment Noise Floor De-Embedded

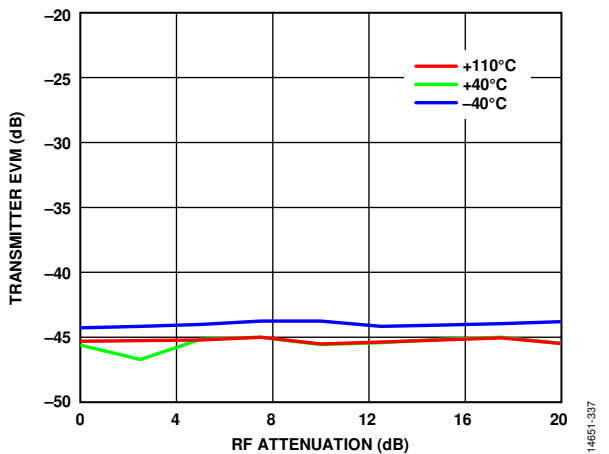

Figure 37. Transmitter EVM vs. RF Attenuation, 900 MHz LO, Transmitter LO Leakage and Transmitter QEC Tracking Active, 20 MHz RF Bandwidth, LTE 20 MHz Downlink Signal, 122.88 MSPS Sample Rate

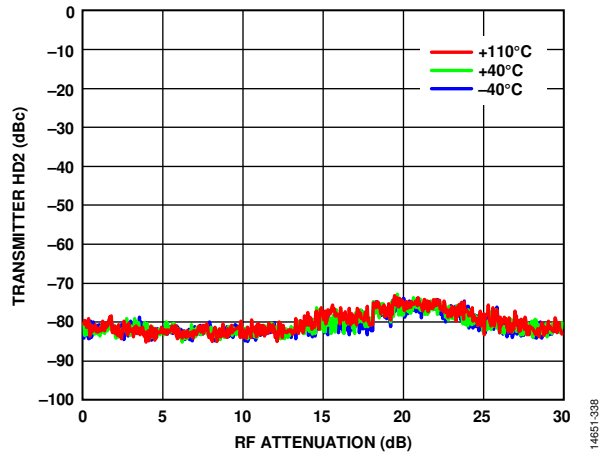

Figure 38. Transmitter HD2 vs. RF Attenuation, 800 MHz LO, 810 MHz CW Desired Signal, 20 MHz RF Bandwidth, 122.88 MSPS Sample Rate

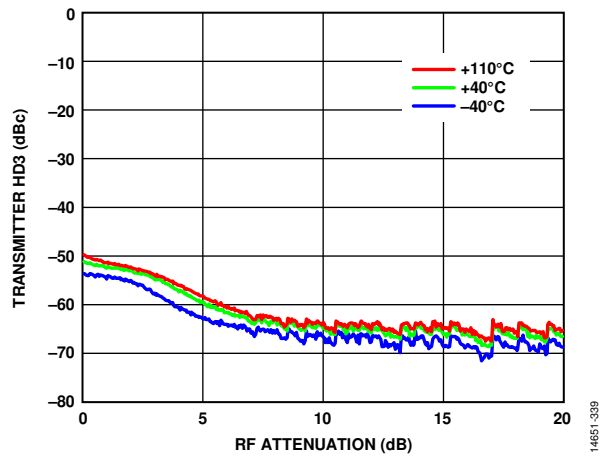

Figure 39. Transmitter HD3 vs. RF Attenuation, 800 MHz LO, 810 MHz CW Desired Signal, 20 MHz RF Bandwidth, 122.88 MSPS Sample Rate

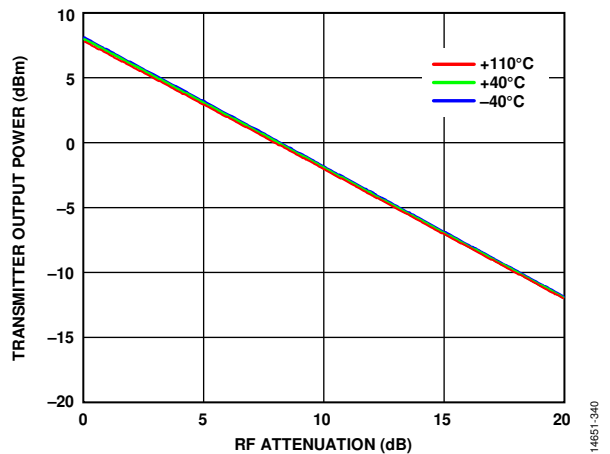

Figure 40. Transmitter Output Power vs. RF Attenuation, 800 MHz LO, 810 MHz CW Desired Signal, 20 MHz RF Bandwidth, 122.88 MSPS Sample Rate

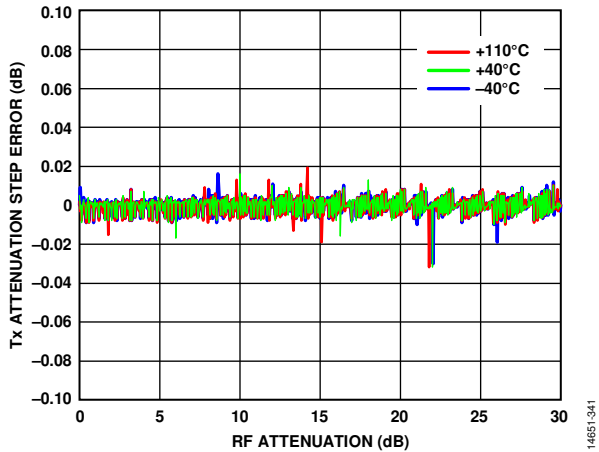

Figure 41. Tx Attenuation Step Error vs. RF Attenuation, 800 MHz LO, 810 MHz CW Desired Signal, 20 MHz RF Bandwidth, 122.88 MSPS Sample Rate

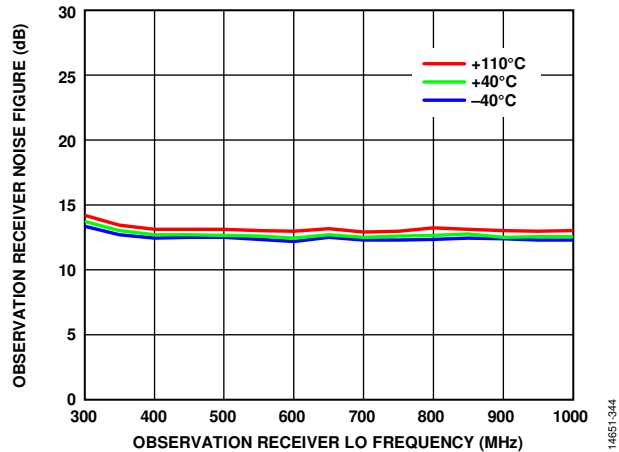

Figure 44. Observation Receiver Noise Figure vs. Observation Receiver LO Frequency, 0 dB Receiver Attenuation, 100 MHz RF Bandwidth, 122.88 MSPS Sample Rate, 100 MHz Integration Bandwidth

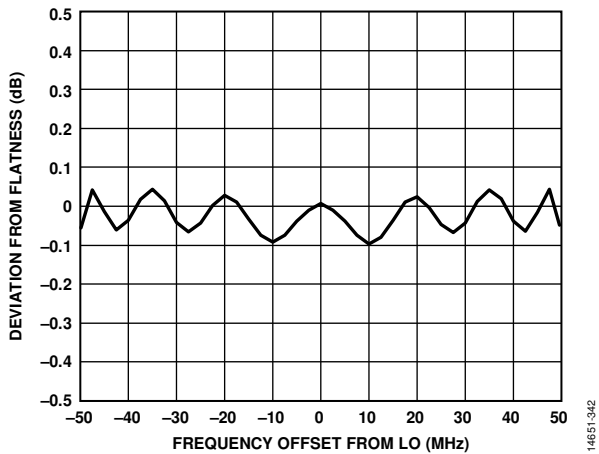

Figure 42. Transmitter Frequency Response Deviation from Flatness vs. Frequency Offset from LO, 800 MHz LO, 20 MHz RF Bandwidth, 6 dB Digital Backoff, 122.88 MSPS Sample Rate

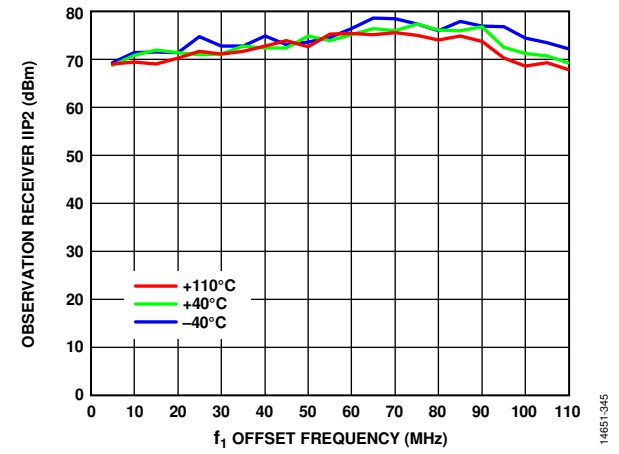

Figure 45. Observation Receiver IIP2 vs. f_1 Offset Frequency, 900 MHz LO, 0 dB Attenuation, 100 MHz RF Bandwidth, $f_2 = f_1 + 1$ MHz, 122.88 MSPS Sample Rate

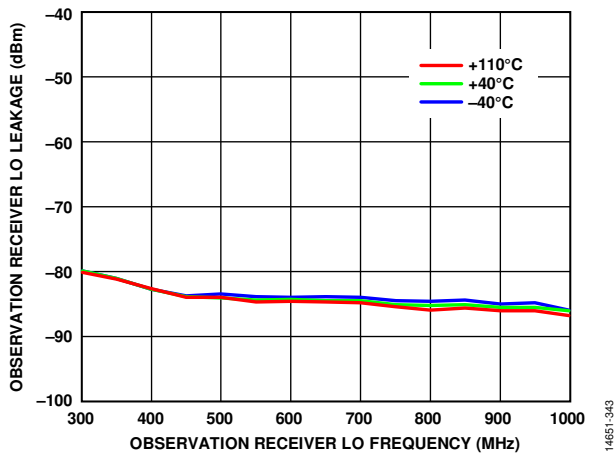

Figure 43. Observation Receiver LO Leakage vs. Observation Receiver LO Frequency, 0 dB Receiver Attenuation, 100 MHz RF Bandwidth, 122.88 MSPS Sample Rate

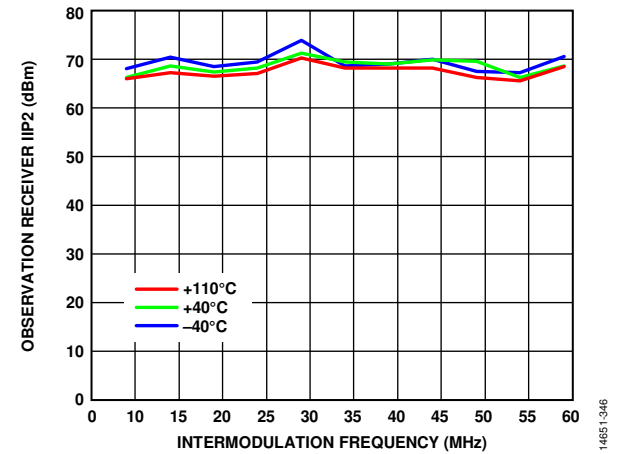

Figure 46. Observation Receiver IIP2 vs. Intermodulation Frequency ($f_2 - f_1$), 900 MHz LO, 0 dB Attenuation, 100 MHz RF Bandwidth, 122.88 MSPS Sample Rate

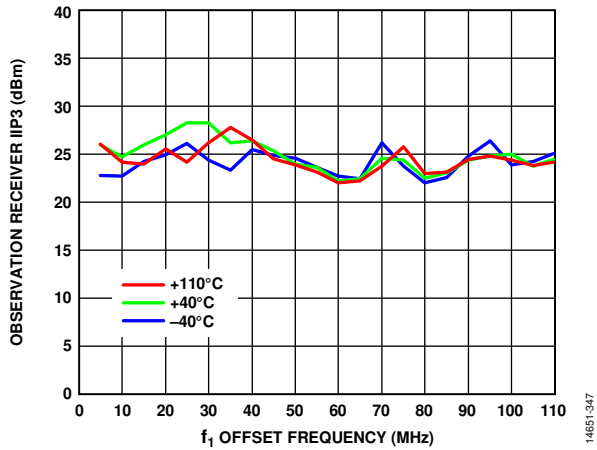

Figure 47. Observation Receiver IIP3 vs. f_1 Offset Frequency, 900 MHz LO, 0 dB Attenuation, 100 MHz RF Bandwidth, $f_2 = 2f_1 + 1$ MHz, 122.88 MSPS Sample Rate

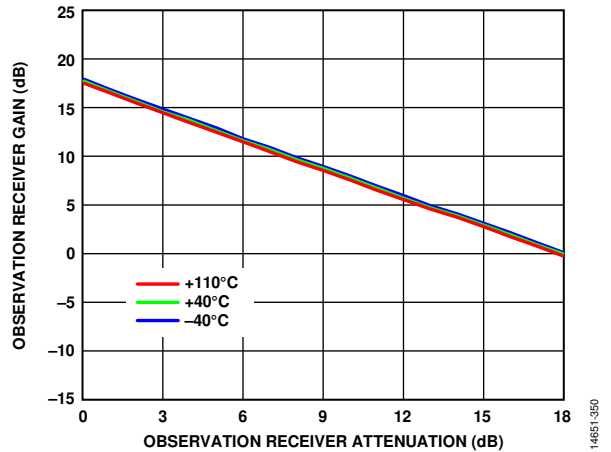

Figure 50. Observation Receiver Gain vs. Observation Receiver Attenuation, 800 MHz LO, CW Signal 16 MHz Offset, 100 MHz RF Bandwidth, 122.88 MSPS Sample Rate

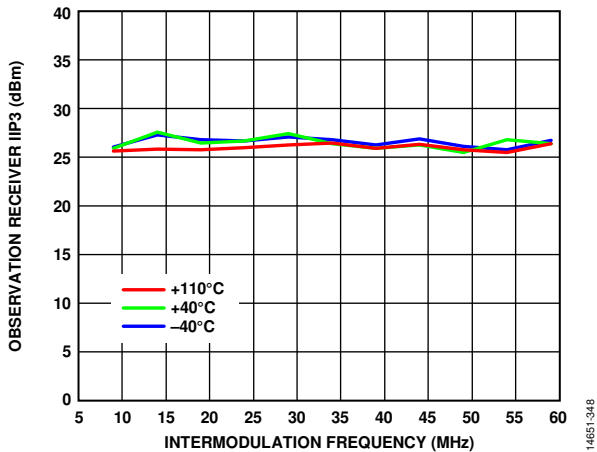

Figure 48. Observation Receiver IIP3 vs. Intermodulation Frequency ($2f_2 - f_1$), 900 MHz LO, 0 dB Attenuation, 100 MHz RF Bandwidth, 122.88 MSPS Sample Rate

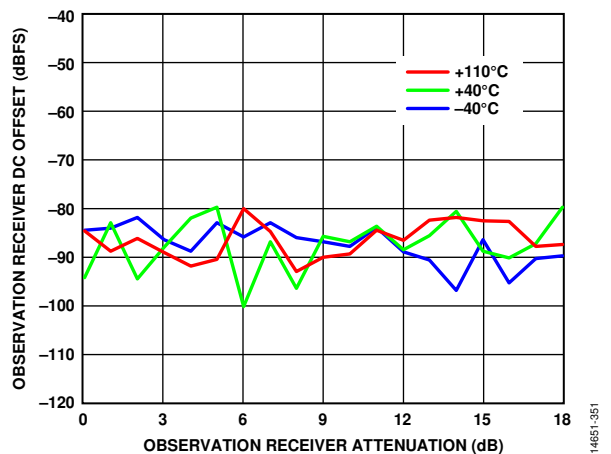

Figure 51. Observation Receiver DC Offset vs. Observation Receiver Attenuation, 800 MHz LO, 100 MHz RF Bandwidth, 122.88 MSPS Sample Rate

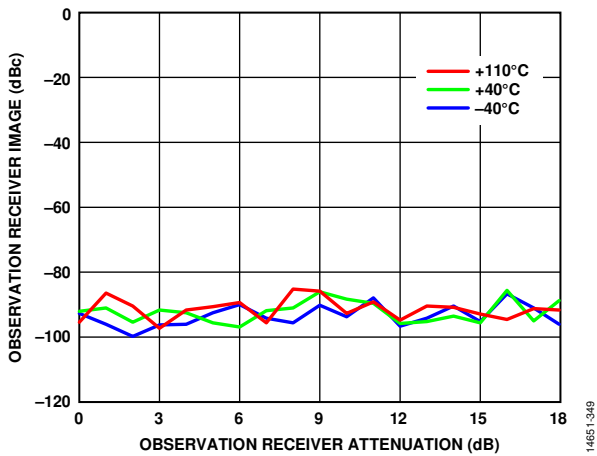

Figure 49. Observation Receiver Image vs. Observation Receiver Attenuation, 800 MHz LO, CW Signal 16 MHz Offset, 100 MHz RF Bandwidth, BTC Active, 122.88 MSPS Sample Rate

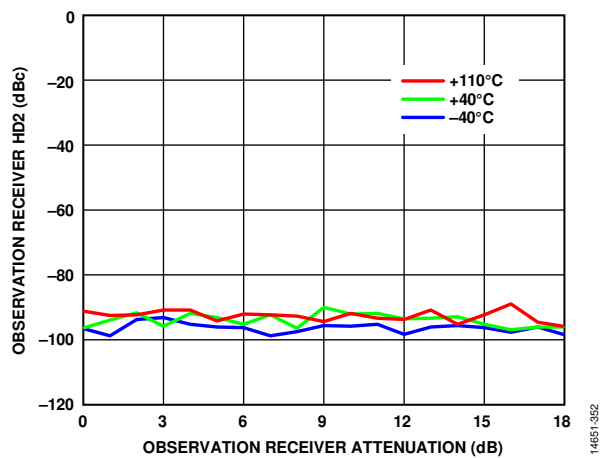

Figure 52. Observation Receiver HD2 vs. Observation Receiver Attenuation, 800 MHz LO, CW Signal 16 MHz Offset, -20 dBm at 0 dB Attenuation, Input Power Increasing Decibel for Decibel with Attenuation, 100 MHz RF Bandwidth, 122.88 MSPS Sample Rate

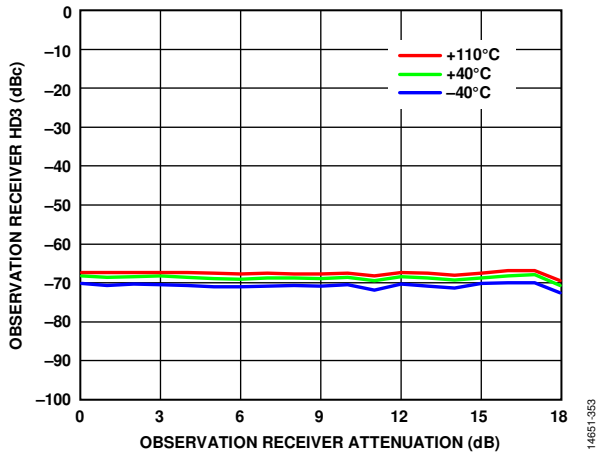

Figure 53. Observation Receiver HD3 vs. Observation Receiver Attenuation, 800 MHz LO, CW Signal 16 MHz Offset, -20 dBm at 0 dB Attenuation, Input Power Increasing Decibel for Decibel with Attenuation, 100 MHz RF Bandwidth, 122.88 MSPS Sample Rate

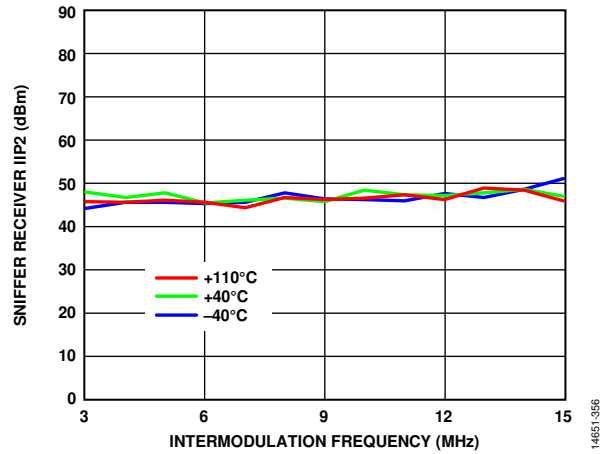

Figure 56. Sniffer Receiver IIP2 vs. Intermodulation Frequency ($f_2 - f_1$), 600 MHz LO, 0 dB Attenuation, 20 MHz RF Bandwidth, 30.72 MSPS Sample Rate

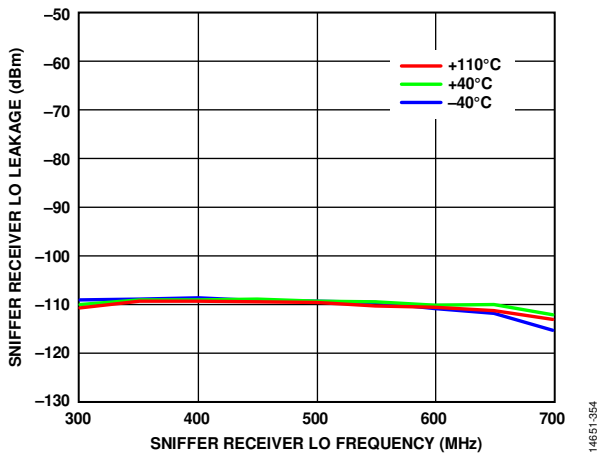

Figure 54. Sniffer Receiver LO Leakage vs. Sniffer Receiver LO Frequency, 0 dB Receiver Attenuation, 20 MHz RF Bandwidth, 30.72 MSPS Sample Rate

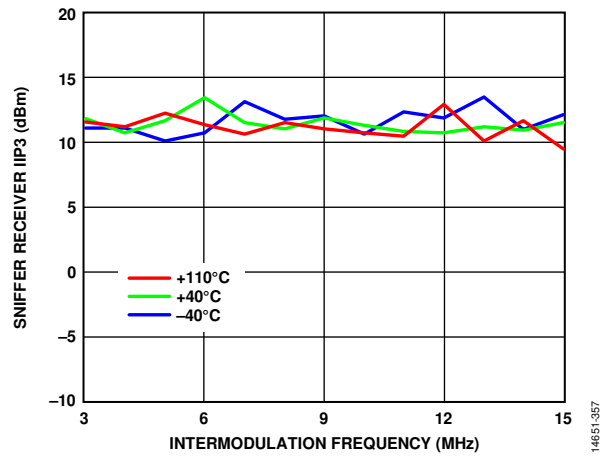

Figure 57. Sniffer Receiver IIP3 vs. Intermodulation Frequency ($f_2 - 2f_1$), 600 MHz LO, 0 dB Attenuation, 20 MHz RF Bandwidth, 30.72 MSPS Sample Rate

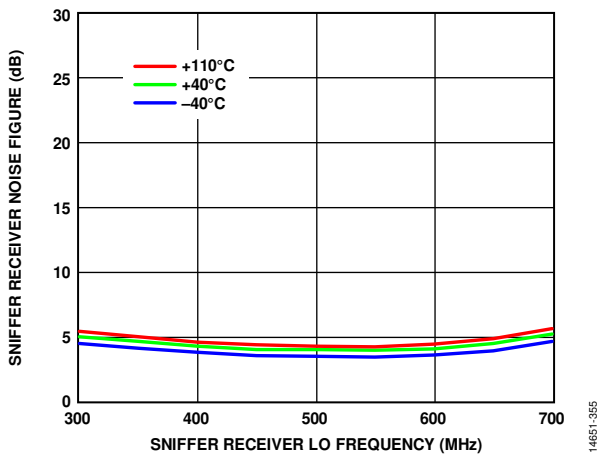

Figure 55. Sniffer Receiver Noise Figure vs. Sniffer Receiver LO Frequency, 0 dB Receiver Attenuation, 20 MHz RF Bandwidth, 30.72 MSPS Sample Rate, 20 MHz Integration Bandwidth

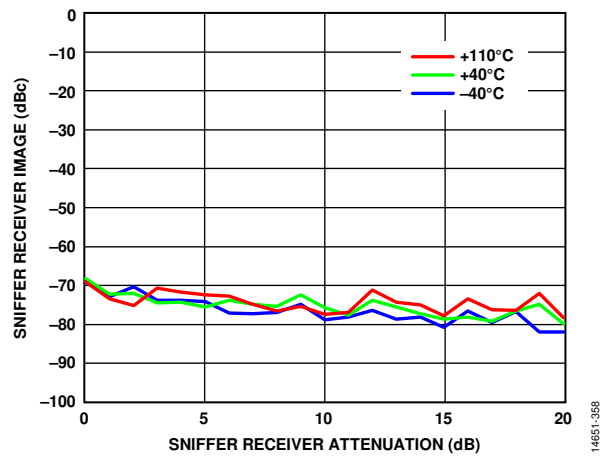

Figure 58. Sniffer Receiver Image vs. Sniffer Receiver Attenuation, 600 MHz LO, CW Signal 3 MHz Offset, 20 MHz RF Bandwidth, 30.72 MSPS Sample Rate

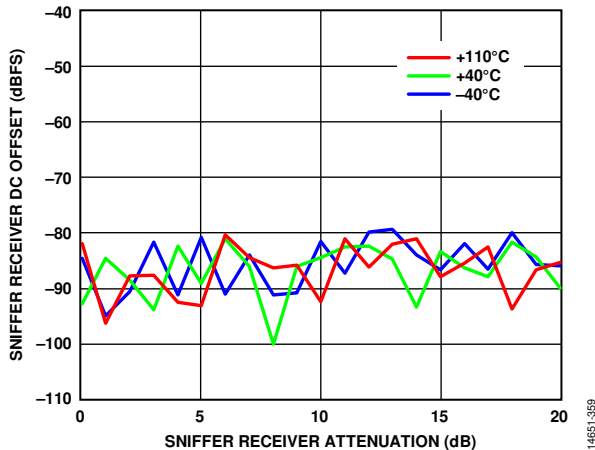

Figure 59. Sniffer Receiver DC Offset vs. Sniffer Receiver Attenuation, 600 MHz LO, CS Signal 3 MHz Offset, -35 dBm at 0 dB Attenuation, Input Power Increasing Decibel for Decibel with Attenuation, 20 MHz RF Bandwidth, 30.72 MSPS Sample Rate

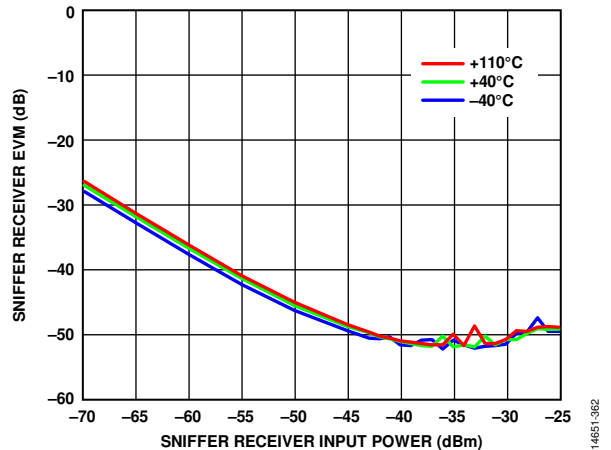

Figure 62. Sniffer Receiver EVM vs. Sniffer Receiver Input Power, 600 MHz LO, 20 MHz RF Bandwidth, LTE 20 MHz Uplink Centered at DC, BTC Active, 30.72 MSPS Sample Rate

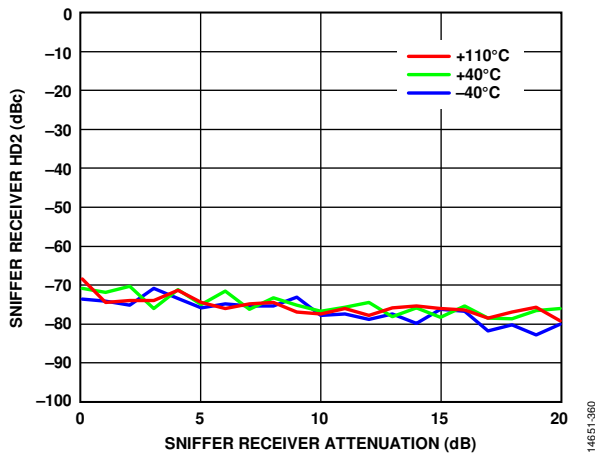

Figure 60. Sniffer Receiver HD2 vs. Sniffer Receiver Attenuation, 600 MHz LO, CW Signal 3 MHz Offset, -35 dBm at 0 dB Attenuation, Input Power Increasing Decibel for Decibel with Attenuation, 20 MHz RF Bandwidth, 30.72 MSPS Sample Rate

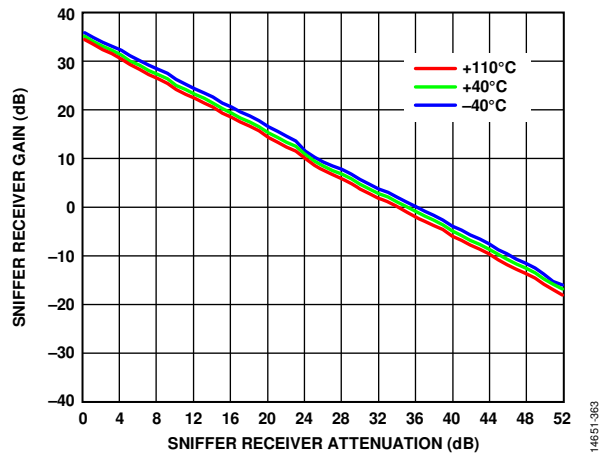

Figure 63. Sniffer Receiver Gain vs. Sniffer Receiver Attenuation, 600 MHz LO, CW Signal 3 MHz Offset, 20 MHz RF Bandwidth, 30.72 MSPS Sample Rate

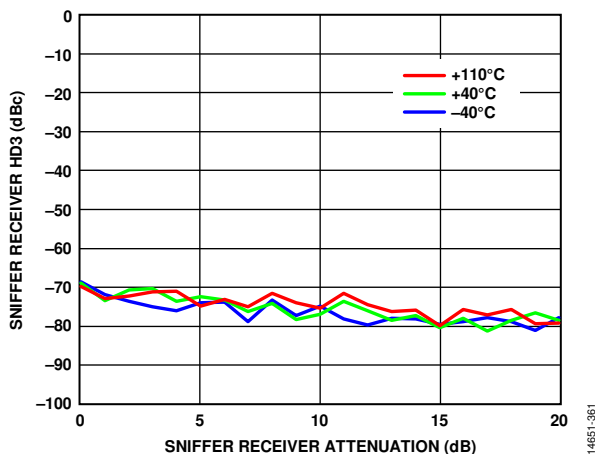

Figure 61. Sniffer Receiver HD3 vs. Sniffer Receiver Attenuation, 600 MHz LO, CW Signal 3 MHz Offset, -35 dBm at 0 dB Attenuation, Input Power Increasing Decibel for Decibel with Attenuation, 20 MHz RF Bandwidth, 30.72 MSPS Sample Rate

2.6 GHz BAND

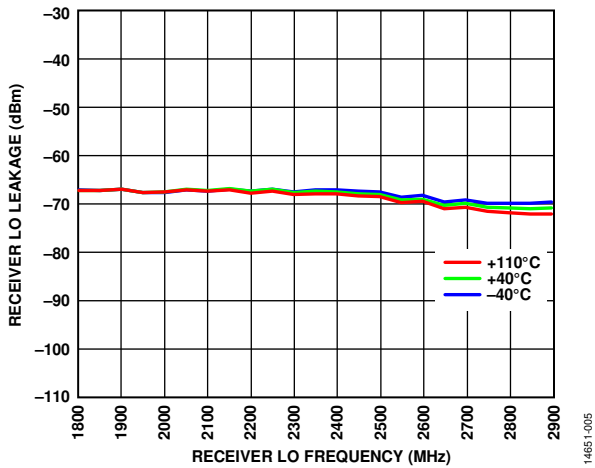

Figure 64. Receiver Local Oscillator (LO) Leakage vs. Receiver LO Frequency, 0 dB Receiver Attenuation, 40 MHz RF Bandwidth, 122.88 MSPS Sample Rate

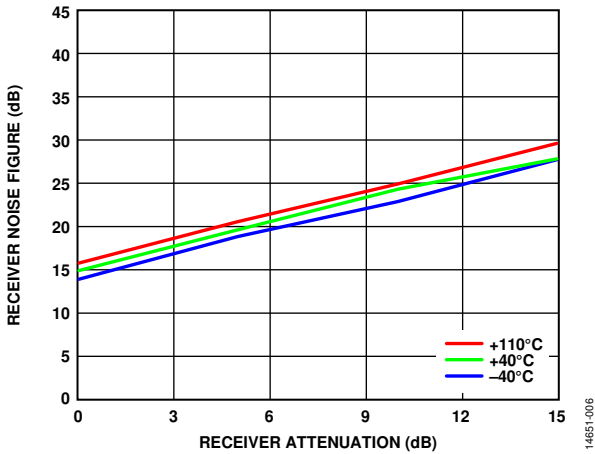

Figure 65. Receiver Noise Figure vs. Receiver Attenuation, 2600 MHz LO, 40 MHz Bandwidth, 122.88 MSPS Sample Rate, 20 MHz Integration Bandwidth (Includes 1.4 dB Matching Circuit Loss)

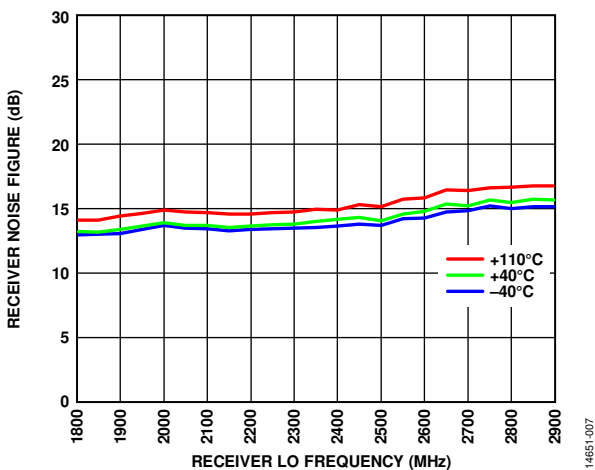

Figure 66. Receiver Noise Figure vs. Receiver LO Frequency, 0 dB Receiver Attenuation, 40 MHz RF Bandwidth, 122.88 MSPS Sample Rate, 20 MHz Integration Bandwidth (Includes 1.4 dB Matching Circuit Loss)

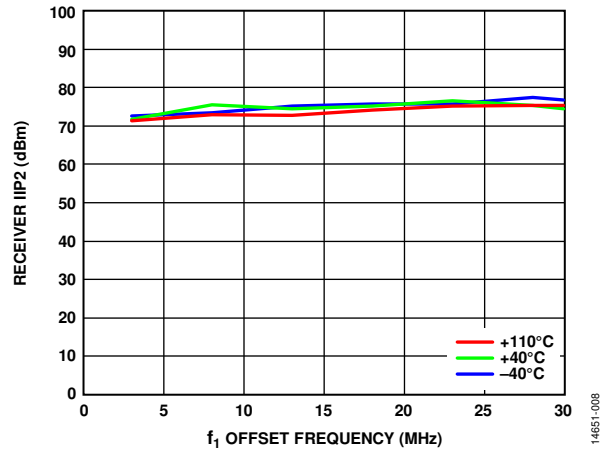

Figure 67. Receiver IIP2 vs. f_1 Offset Frequency, 2600 MHz LO, 0 dB Attenuation, 40 MHz RF Bandwidth, $f_2 = f_1 + 1$ MHz, 122.88 MSPS Sample Rate

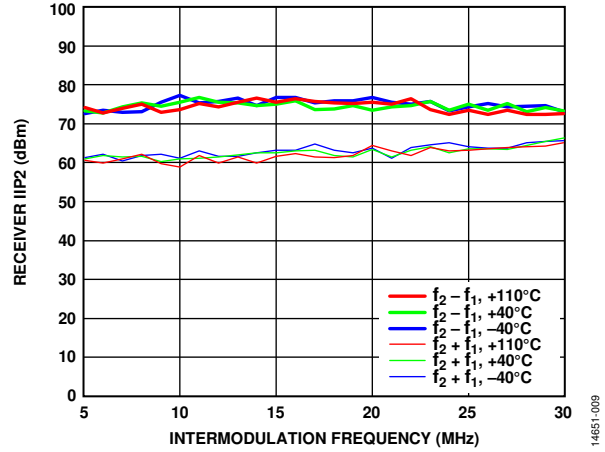

Figure 68. Receiver IIP2 vs. Intermodulation Frequency, 2600 MHz LO, 0 dB Attenuation, 40 MHz RF Bandwidth, 122.88 MSPS Sample Rate

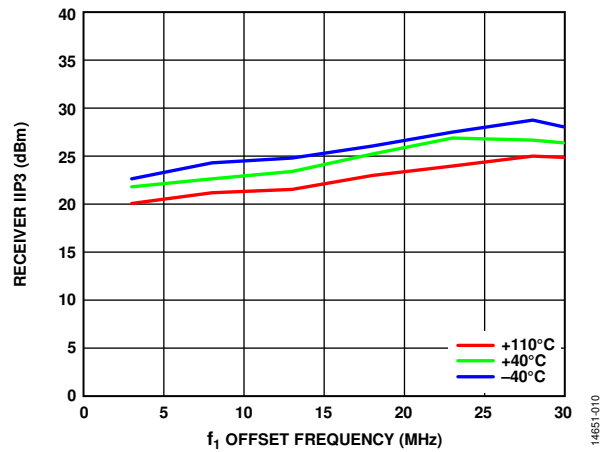

Figure 69. Receiver IIP3 vs. f_1 Offset Frequency, 2600 MHz LO, 0 dB Attenuation, 40 MHz RF Bandwidth, $f_2 = 2 f_1 + 2$ MHz, 122.88 MSPS Sample Rate

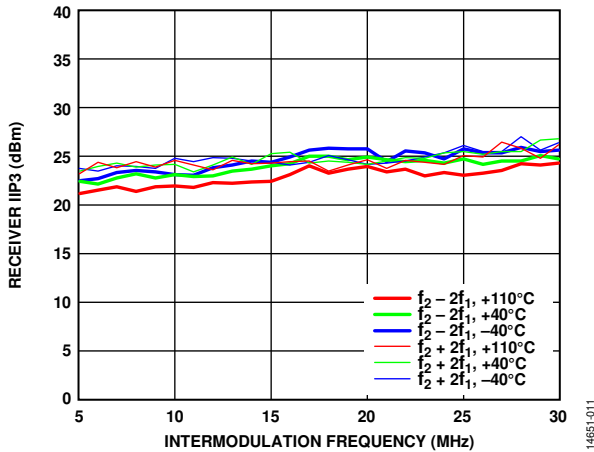

Figure 70. Receiver IIP3 vs. Intermodulation Frequency, 2600 MHz LO, 0 dB Attenuation, 40 MHz RF Bandwidth, 122.88 MSPS Sample Rate

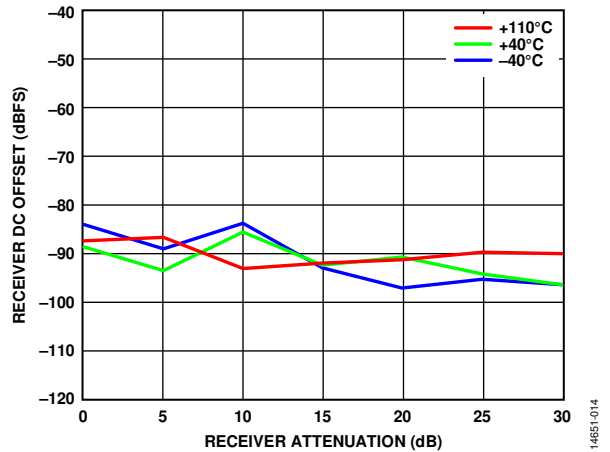

Figure 73. Receiver DC Offset vs. Receiver Attenuation, 2550 MHz LO, 40 MHz RF Bandwidth, 122.88 MSPS Sample Rate

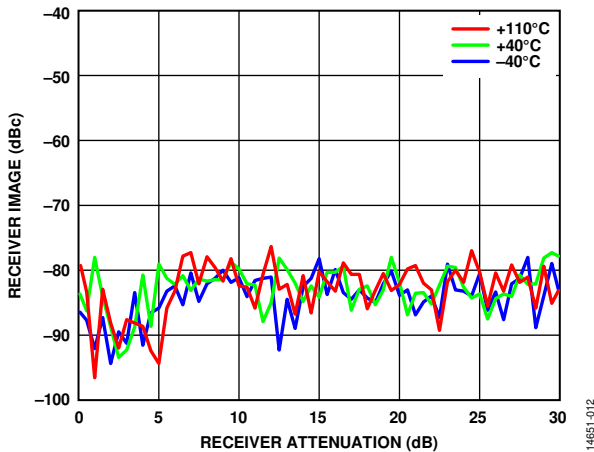

Figure 71. Receiver Image vs. Receiver Attenuation, 2600 MHz LO, Continuous Wave (CW) Signal 5 MHz Offset, 40 MHz RF Bandwidth, Background Tracking Calibration (BTC) Active, 122.88 MSPS Sample Rate

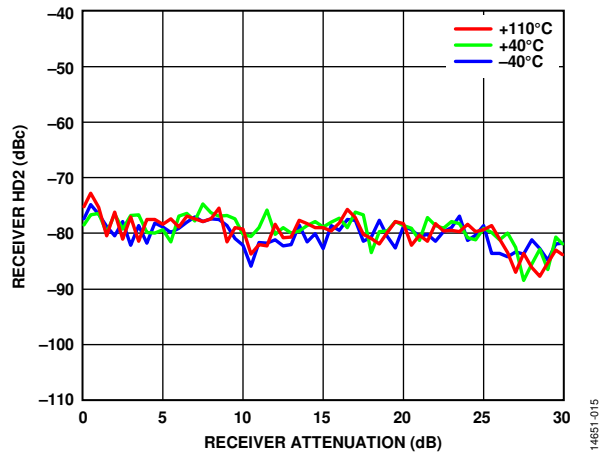

Figure 74. Receiver HD2 vs. Receiver Attenuation, 2600 MHz LO, CW Signal 5 MHz Offset, -20 dBm at 0 dB Attenuation, Input Power Increasing Decibel for Decibel with Attenuation, 40 MHz RF Bandwidth, 122.88 MSPS Sample Rate

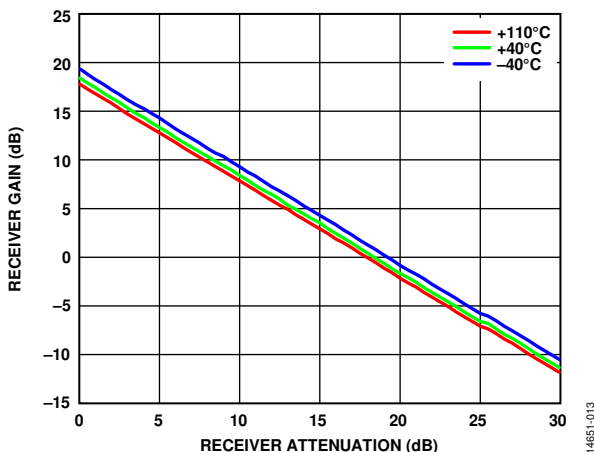

Figure 72. Receiver Gain vs. Receiver Attenuation, 2600 MHz LO, CW Signal 5 MHz Offset, 40 MHz RF Bandwidth, 122.88 MSPS Sample Rate

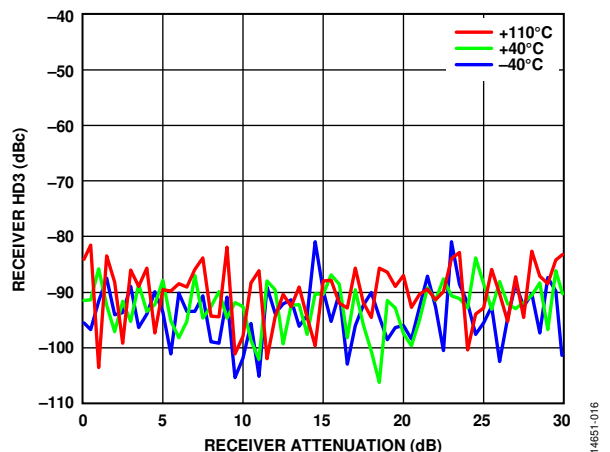

Figure 75. Receiver HD3 vs. Receiver Attenuation, 2600 MHz LO, CW Signal 5 MHz Offset, -20 dBm at 0 dB Attenuation, Input Power Increasing Decibel for Decibel with Attenuation, 40 MHz RF Bandwidth, 122.88 MSPS Sample Rate

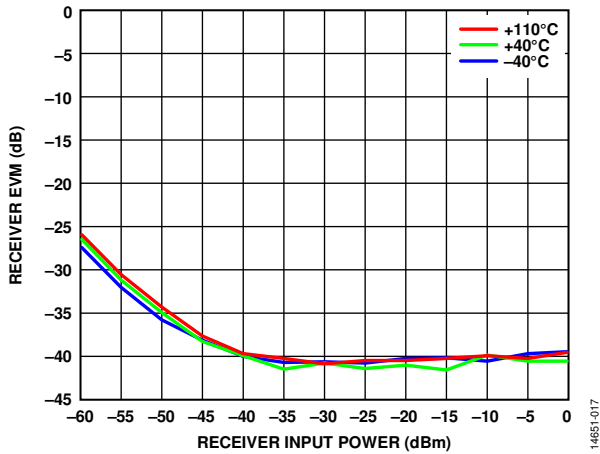

Figure 76. Receiver Error Vector Magnitude (EVM) vs. Receiver Input Power, 2600 MHz LO, 40 MHz RF Bandwidth, LTE 20 MHz Uplink Centered at DC, BTC Active, 122.88 MSPS Sample Rate

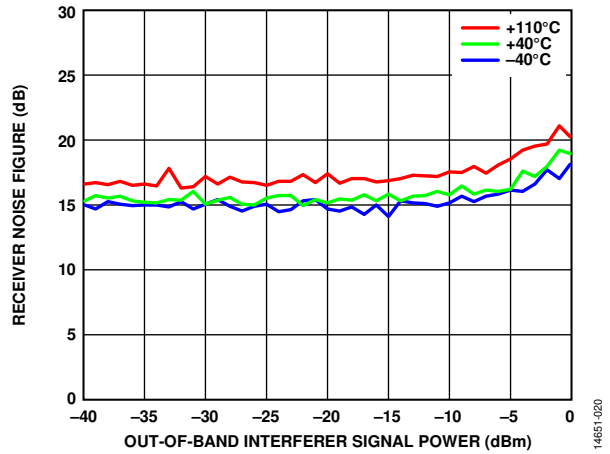

Figure 79. Receiver Noise Figure vs. Out-of-Band Interferer Signal Power, 2614 MHz LO, 2435 MHz CW Interferer, Noise Figure Integrated over 7 MHz to 10 MHz

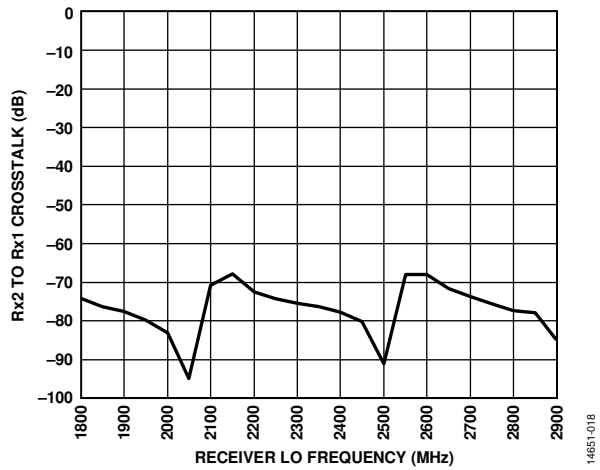

Figure 77. Rx2 to Rx1 Crosstalk vs. Receiver LO Frequency, 40 MHz RF Bandwidth, CW Tone 3 MHz Offset from LO

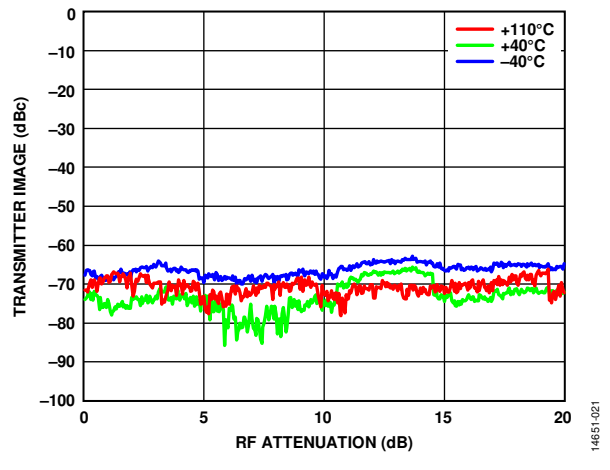

Figure 80. Transmitter Image vs. RF Attenuation, 40 MHz RF Bandwidth, 2600 MHz LO, Transmitter Quadrature Error Correction (QEC) Tracking Run with Two 20 MHz LTE Downlink Carriers, Then Image Measured with CW 10 MHz Offset from LO, 3 dB Digital Backoff, 245.76 MSPS Sample Rate

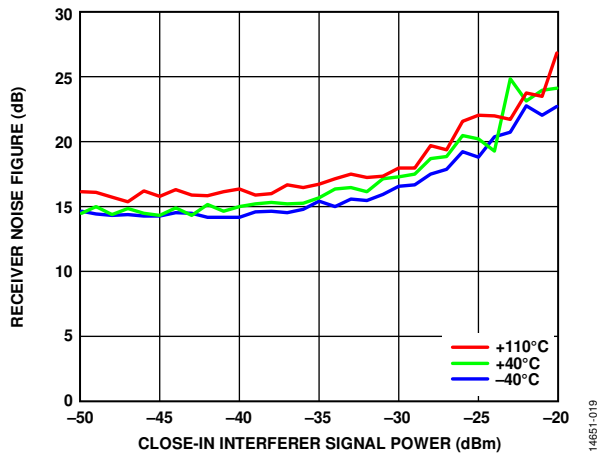

Figure 78. Receiver Noise Figure vs. Close-In Interferer Signal Power, 2614 MHz LO, 2625 MHz CW Interferer, Noise Figure Integrated over 7 MHz to 10 MHz, 40 MHz RF Bandwidth

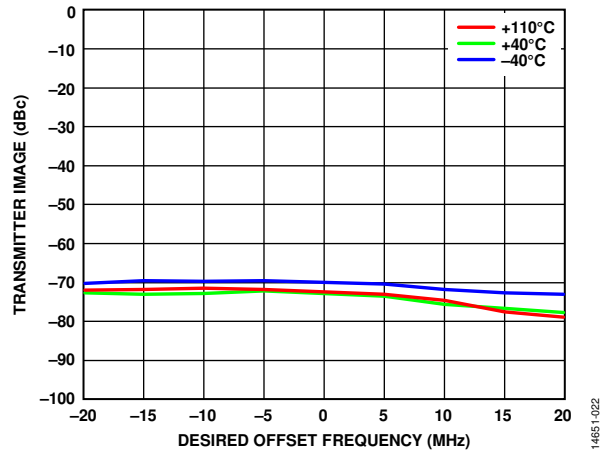

Figure 81. Transmitter Image vs. Desired Offset Frequency, 40 MHz RF Bandwidth, 2300 MHz LO, 0 dB RF Attenuation, Transmitter QEC Tracking Run with Two 20 MHz LTE Downlink Carriers, Then Image Measured with CW Signal, 3 dB Digital Backoff, 245.76 MSPS Sample Rate

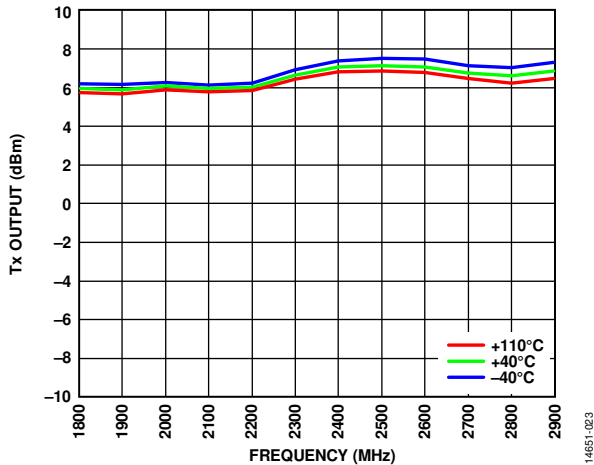

Figure 82. Tx Output Power, Transmitter QEC, and External LO Leakage Active, 5 MHz CW Offset Signal, 1 MHz Resolution Bandwidth, 245.76 MSPS Sample Rate

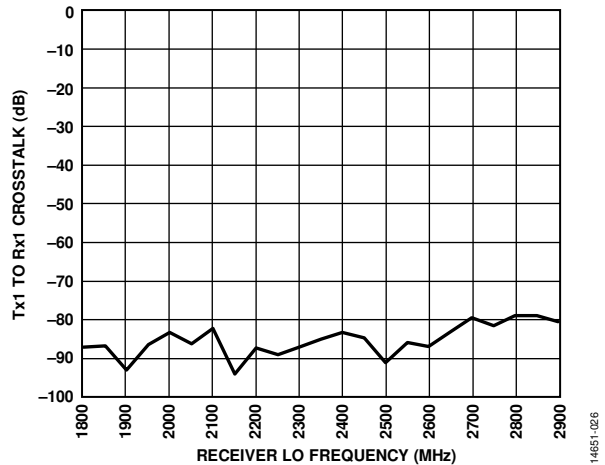

Figure 85. Tx1 to Rx1 Crosstalk vs. Receiver LO Frequency, 40 MHz Receiver RF Bandwidth, 40 MHz Transmitter RF Bandwidth, CW Signal 3 MHz Offset from LO

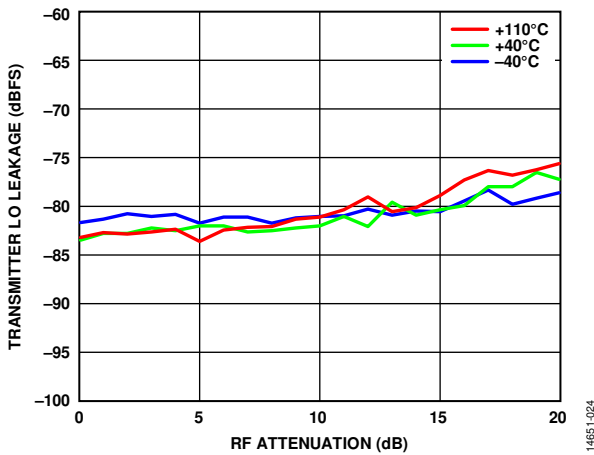

Figure 83. Transmitter LO Leakage vs. RF Attenuation, 2300 MHz LO, External Transmitter QEC and LO Leakage Tracking Active, CW Signal 10 MHz Offset from LO, 6 dB Digital Backoff, 1 MHz Measurement Bandwidth (If Input Power to the ORx Channel Is Not Held Constant, Device Performance Degrades as Shown in This Figure)

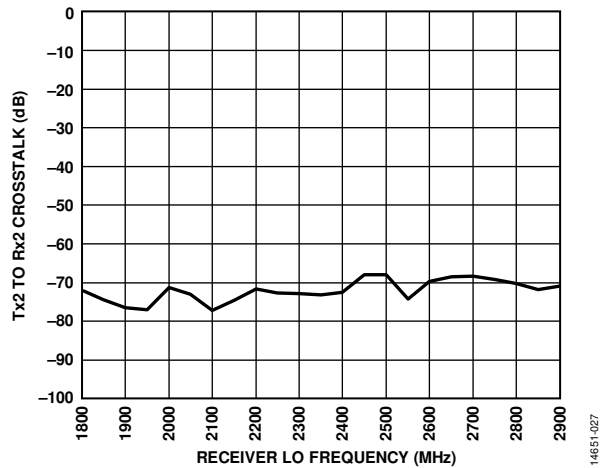

Figure 86. Tx2 to Rx2 Crosstalk vs. Receiver LO Frequency, 40 MHz Receiver RF Bandwidth, 40 MHz Transmitter RF Bandwidth, CW Signal 3 MHz Offset from LO

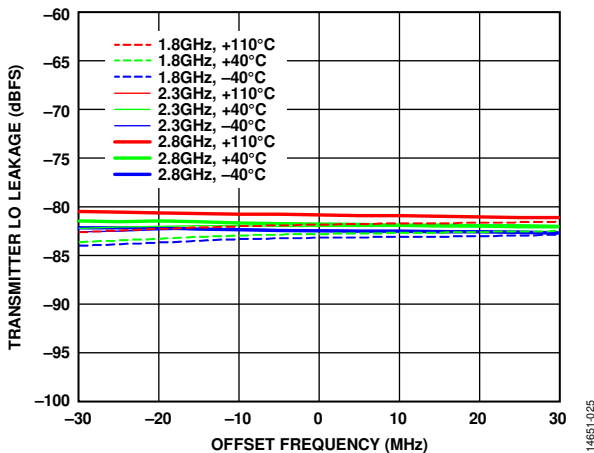

Figure 84. Transmitter LO Leakage vs. Offset Frequency, External Transmitter QEC and LO Leakage Tracking Active, 6 dB Digital Backoff, 1 MHz Measurement Bandwidth

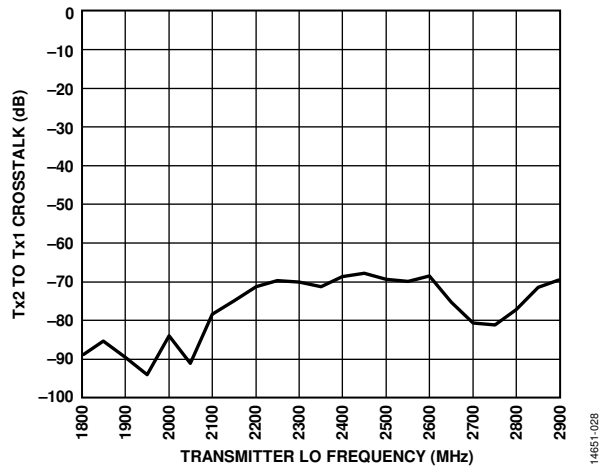

Figure 87. Tx2 to Tx1 Crosstalk vs. Transmitter LO Frequency, 40 MHz RF Bandwidth, CW Signal 3 MHz Offset from LO

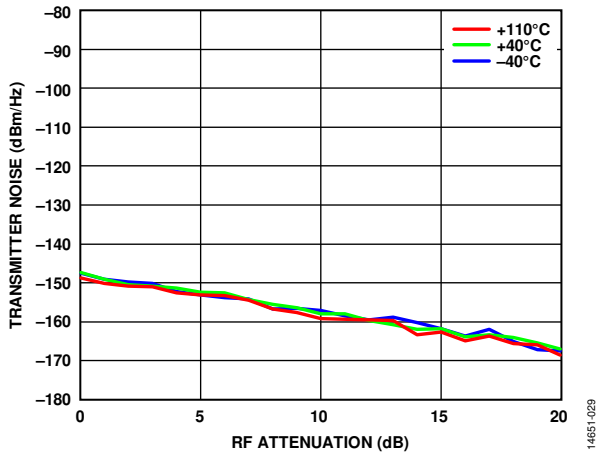

Figure 88. Transmitter Noise vs. RF Attenuation, 2600 MHz LO, 10 MHz Offset Frequency

14651-029

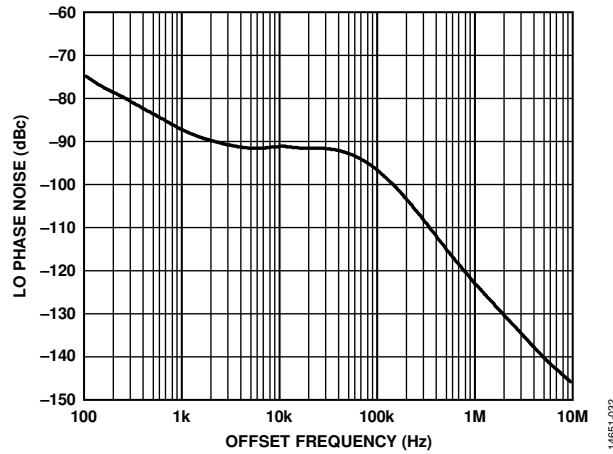

Figure 91. LO Phase Noise vs. Offset Frequency, 3 dB Digital Backoff, 2600 MHz

14651-032

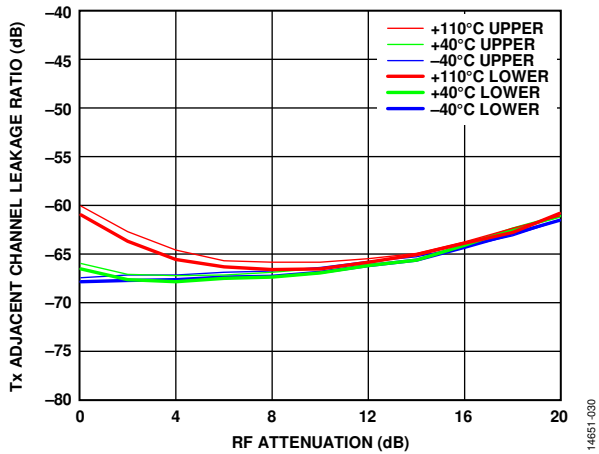

Figure 89. Tx Adjacent Channel Leakage Ratio vs. RF Attenuation, 2600 MHz LO, 40 MHz RF Bandwidth, Four-Carrier W-CDMA Desired Signal, Transmitter QEC and LO Leakage Tracking Active

14651-030

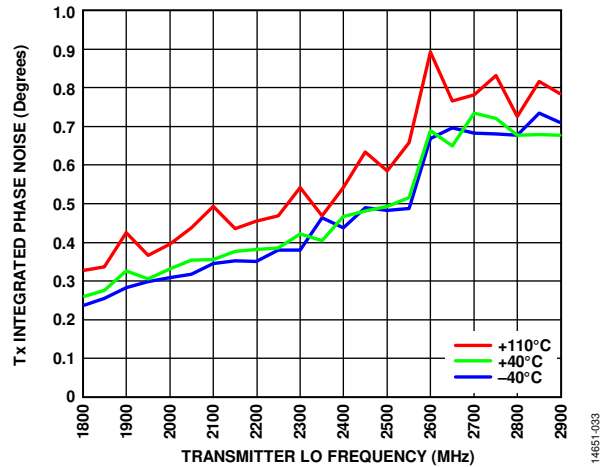

Figure 92. Tx Integrated Phase Noise vs. Transmitter LO Frequency, 40 MHz RF Bandwidth, Continuous Wave 20 MHz Offset from LO, 3 dB Digital Backoff

14651-033

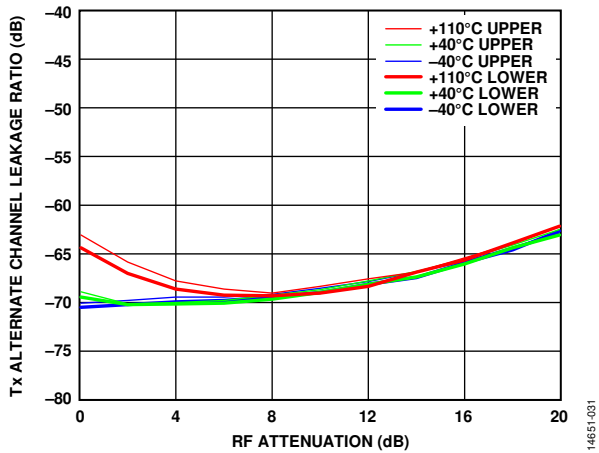

Figure 90. Tx Alternate Channel Leakage Ratio vs. RF Attenuation, 2600 MHz LO, 40 MHz RF Bandwidth, Four-Carrier W-CDMA Desired Signal, 2 dB Digital Backoff, Transmitter QEC and LO Leakage Tracking Active

14651-031

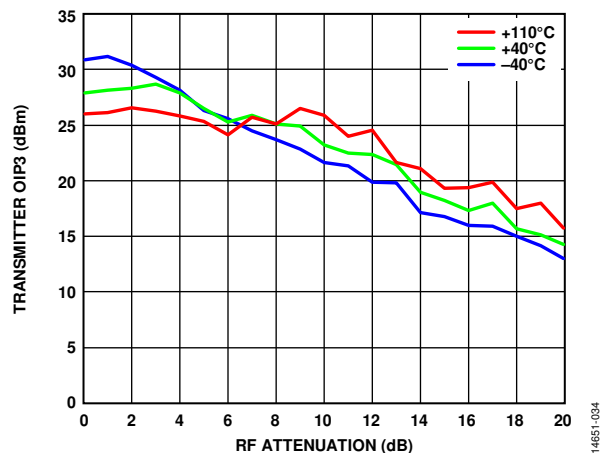

Figure 93. Transmitter OIP3 vs. RF Attenuation, 2600 MHz LO, 40 MHz RF Bandwidth, $f_1 = 20$ MHz, $f_2 = 21$ MHz, 3 dB Digital Backoff, 245.76 MSPS Sample Rate

14651-034

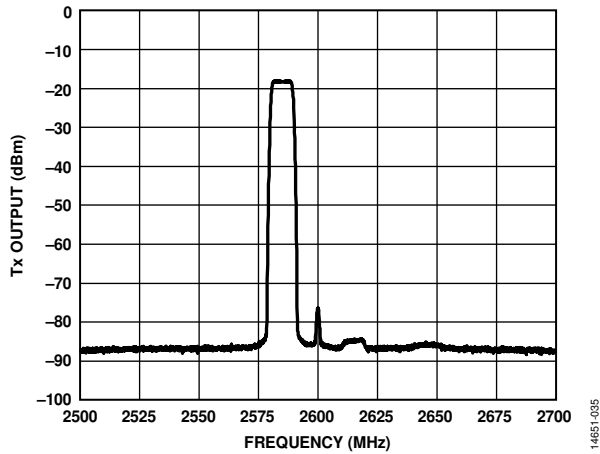

Figure 94. Tx Output Power Spectrum, 2 dB Digital and 3 dB RF Backoff, 40 MHz RF Bandwidth, Transmitter QEC and Internal LO Leakage Active, LTE 10 MHz Signal, 2600 MHz LO, 1 MHz Resolution Bandwidth, 245.76 MSPS Sample Rate

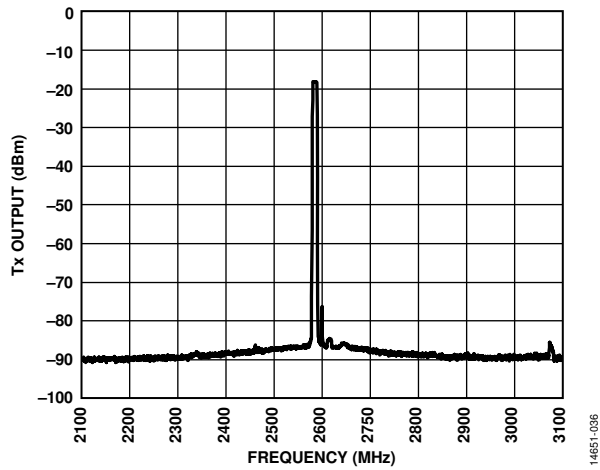

Figure 95. Tx Output Power Spectrum, 2 dB Digital and 3 dB RF Backoff, 40 MHz RF Bandwidth, Transmitter QEC and Internal LO Leakage Active, LTE 10 MHz Signal, 2600 MHz LO, 1 MHz Resolution Bandwidth, 245.76 MSPS Sample Rate

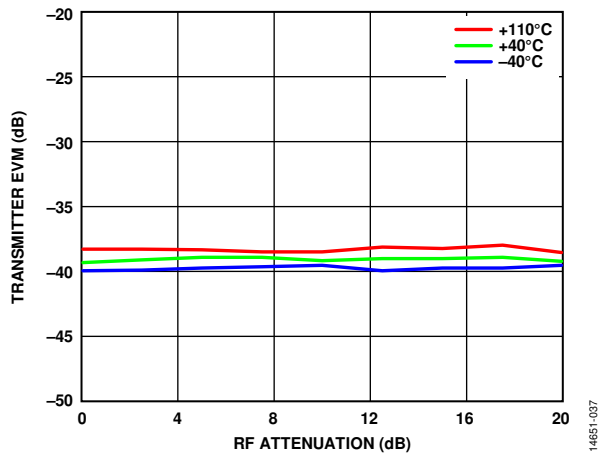

Figure 96. Transmitter EVM vs. RF Attenuation, 2550 MHz LO, Transmitter LO Leakage and Transmitter QEC Tracking Active, 200 MHz RF Bandwidth, LTE 20 MHz Downlink Signal, 245.76 MSPS Sample Rate

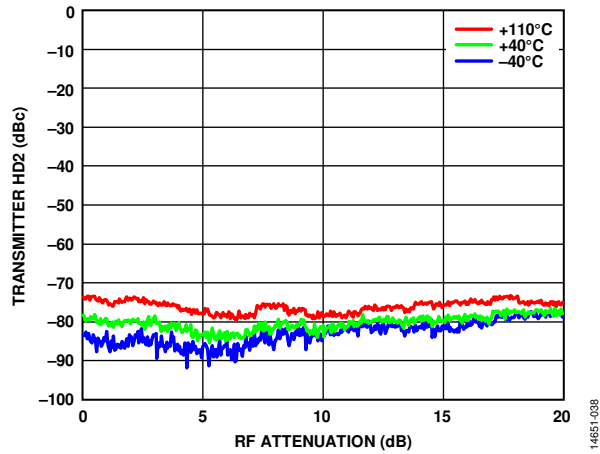

Figure 97. Transmitter HD2 vs. RF Attenuation, 2600 MHz LO, 2605 MHz CW Desired Signal, 40 MHz RF Bandwidth, 245.76 MSPS Sample Rate

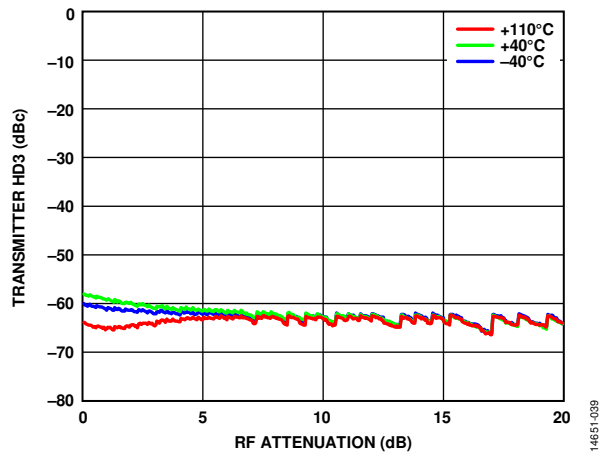

Figure 98. Transmitter HD3 vs. RF Attenuation, 2600 MHz LO, 2605 MHz CW Desired Signal, 40 MHz RF Bandwidth, 245.76 MSPS Sample Rate

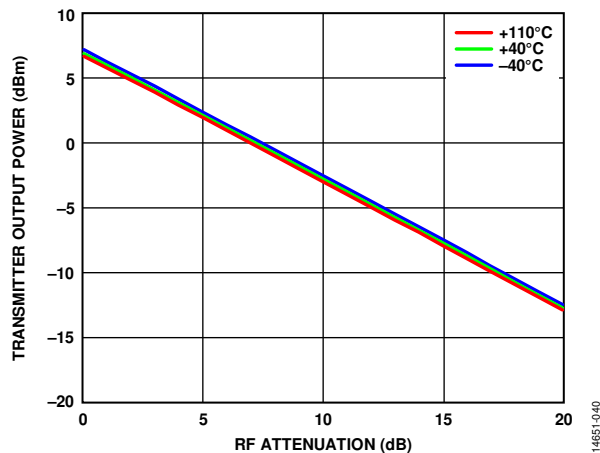

Figure 99. Transmitter Output Power vs. RF Attenuation, 2600 MHz LO, 2605 MHz CW Desired Signal, 40 MHz RF Bandwidth, 245.76 MSPS Sample Rate

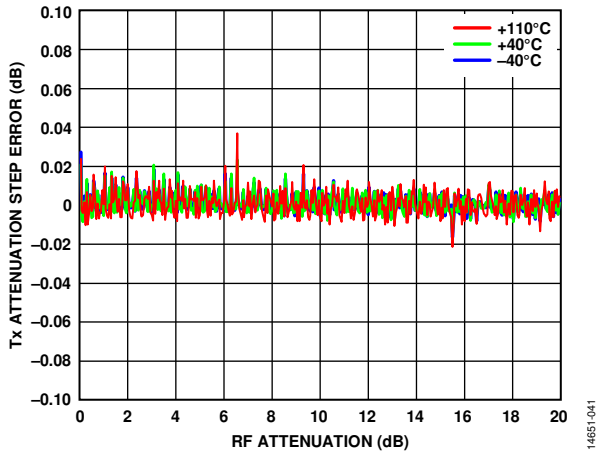

Figure 100. Tx Attenuation Step Error vs. RF Attenuation, 2600 MHz LO, 2610 MHz CW Desired Signal, 40 MHz RF Bandwidth, 245.76 MSPS Sample Rate

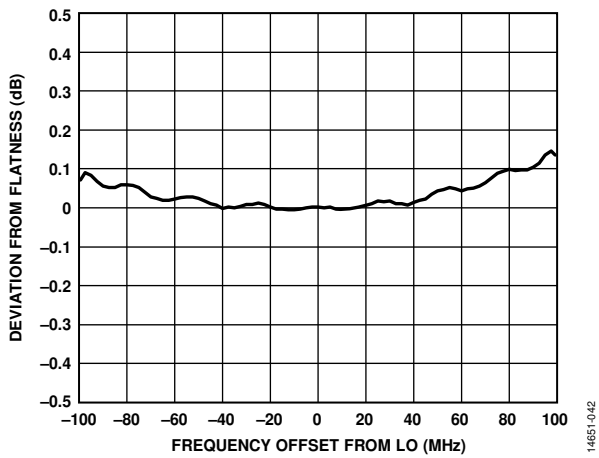

Figure 101. Transmitter Frequency Response Deviation from Flatness vs. Frequency Offset from LO, 2600 MHz LO, 100 MHz RF Bandwidth, 6 dB Digital Backoff, 245.76 MSPS Sample Rate

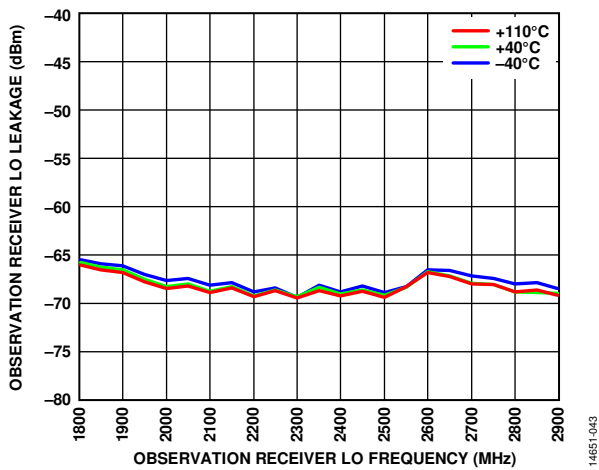

Figure 102. Observation Receiver LO Leakage vs. Observation Receiver LO Frequency, 0 dB Receiver Attenuation, 200 MHz RF Bandwidth, 245.76 MSPS Sample Rate

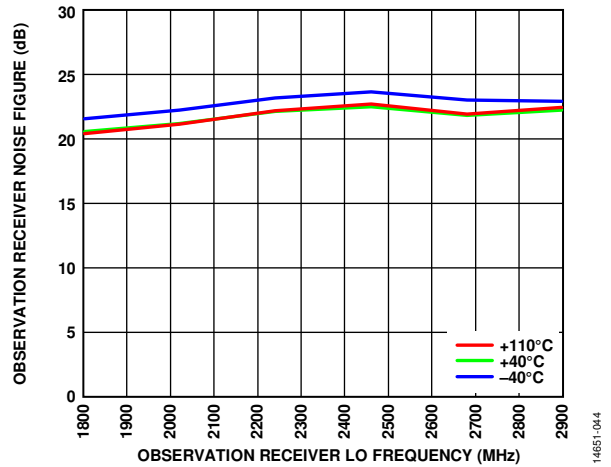

Figure 103. Observation Receiver Noise Figure vs. Observation Receiver LO Frequency, 0 dB Receiver Attenuation, 200 MHz RF Bandwidth, 245.76 MSPS Sample Rate, 100 MHz Integration Bandwidth

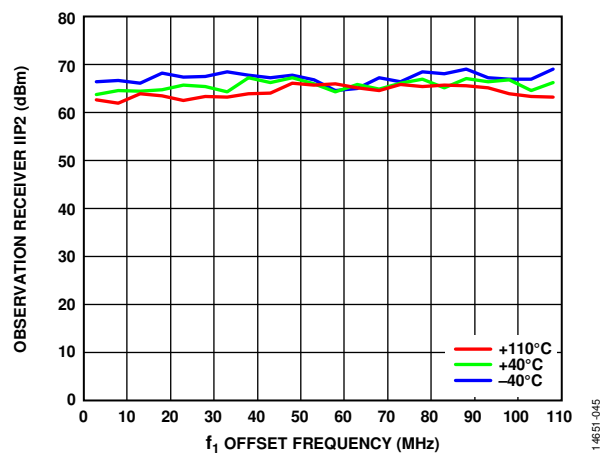

Figure 104. Observation Receiver IIP2 vs. f_1 Offset Frequency, 2600 MHz LO, 0 dB Attenuation, 200 MHz RF Bandwidth, $f_2 = f_1 + 1$ MHz, 245.76 MSPS Sample Rate

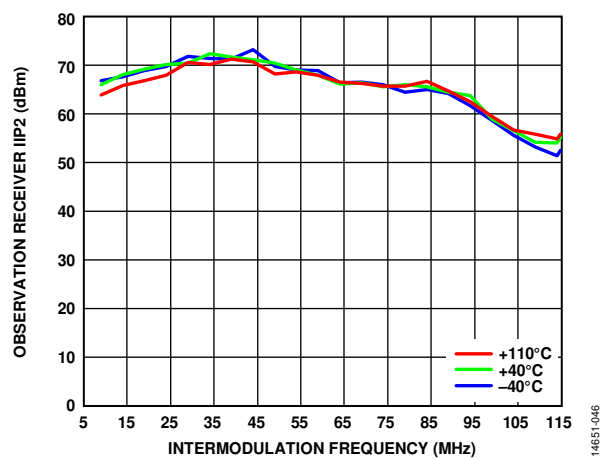

Figure 105. Observation Receiver IIP2 vs. Intermodulation Frequency ($f_2 - f_1$), 2600 MHz LO, 0 dB Attenuation, 200 MHz RF Bandwidth, 245.76 MSPS Sample Rate

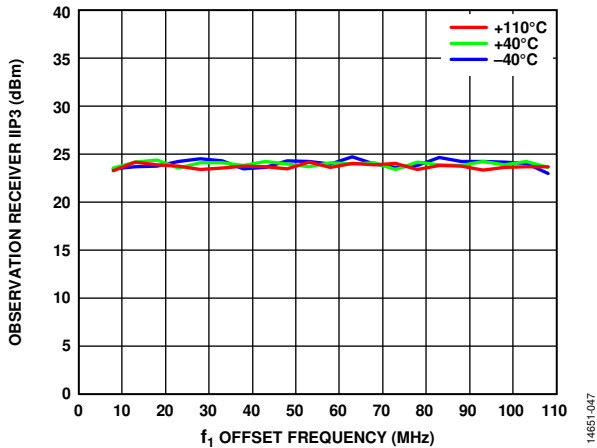

Figure 106. Observation Receiver IIP3 vs. f_1 Offset Frequency, 2600 MHz LO, 0 dB Attenuation, 200 MHz RF Bandwidth, $f_2 = 2f_1 + 1$ MHz, 245.76 MSPS Sample Rate

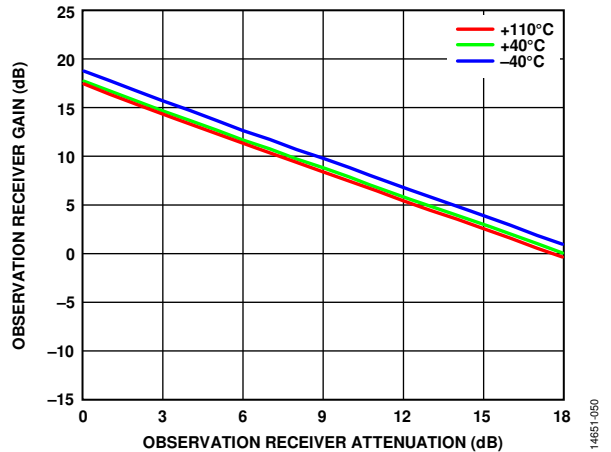

Figure 109. Observation Receiver Gain vs. Observation Receiver Attenuation, 2600 MHz LO, CW Signal 25 MHz Offset, 200 MHz RF Bandwidth, 245.76 MSPS Sample Rate

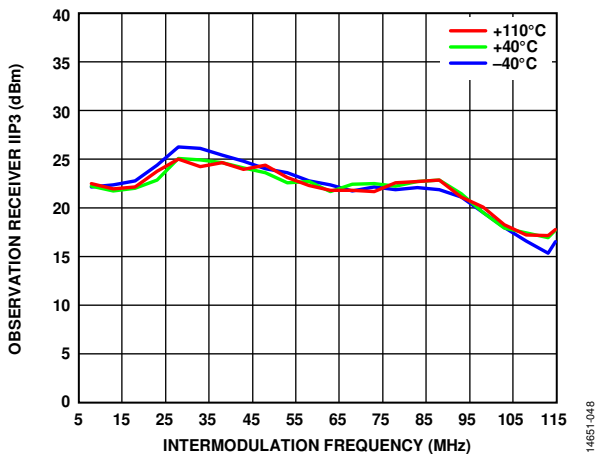

Figure 107. Observation Receiver IIP3 vs. Intermodulation Frequency ($f_2 - 2f_1$), 2600 MHz LO, 0 dB Attenuation, 200 MHz RF Bandwidth, 245.76 MSPS Sample Rate

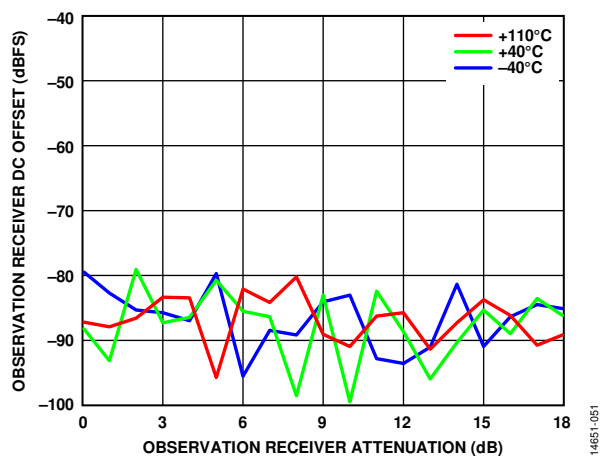

Figure 110. Observation Receiver DC Offset vs. Observation Receiver Attenuation, 2600 MHz LO, 200 MHz RF Bandwidth, 245.76 MSPS Sample Rate

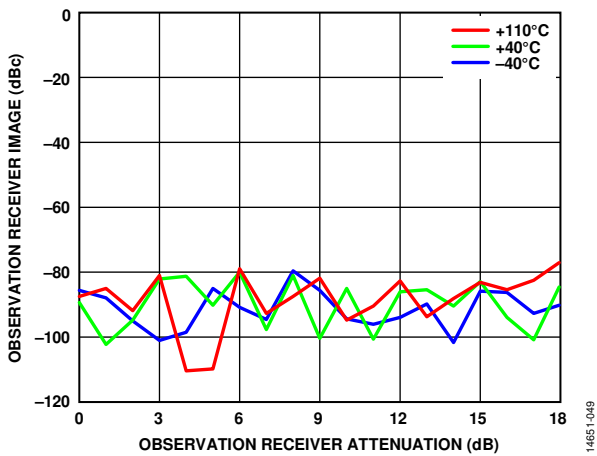

Figure 108. Observation Receiver Image vs. Observation Receiver Attenuation, 2600 MHz LO, CW Signal 25 MHz Offset, 200 MHz RF Bandwidth, BTC Active, 245.76 MSPS Sample Rate

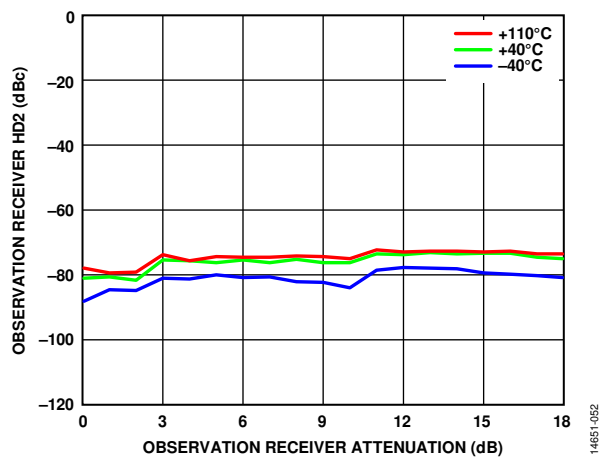

Figure 111. Observation Receiver HD2 vs. Observation Receiver Attenuation, 2600 MHz LO, CW Signal 25 MHz Offset, -20 dBm at 0 dB Attenuation, Input Power Increasing Decibel for Decibel with Attenuation, 200 MHz RF Bandwidth, 245.76 MSPS Sample Rate

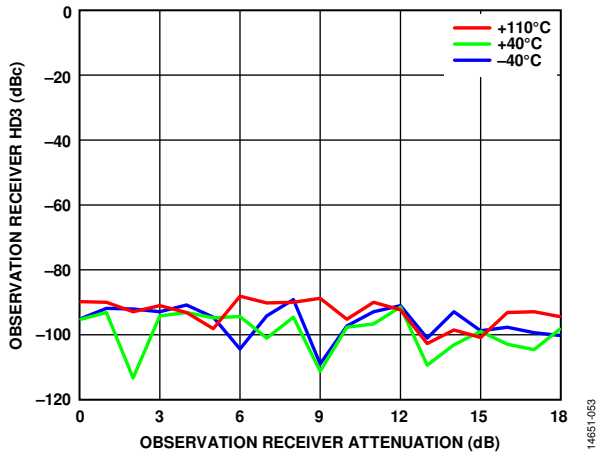

Figure 112. Observation Receiver HD3 vs. Observation Receiver Attenuation, 2600 MHz LO, CW Signal 25 MHz Offset, -20 dBm at 0 dB Attenuation, Input Power Increasing Decibel for Decibel with Attenuation, 200 MHz RF Bandwidth, 245.76 MSPS Sample Rate

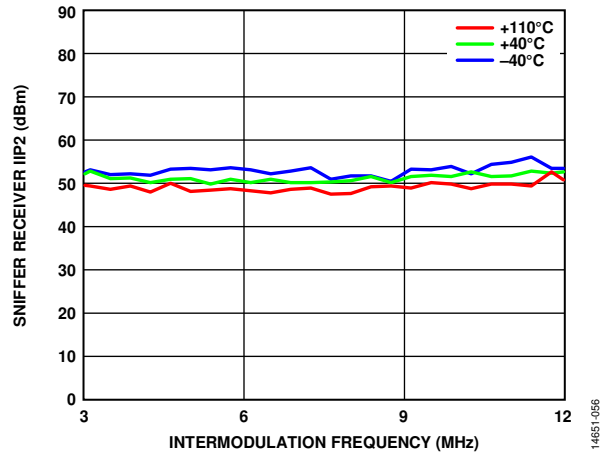

Figure 115. Sniffer Receiver IIP2 vs. Intermodulation Frequency ($f_2 - f_1$), 2600 MHz LO, 0 dB Attenuation, 20 MHz RF Bandwidth, 30.72 MSPS Sample Rate

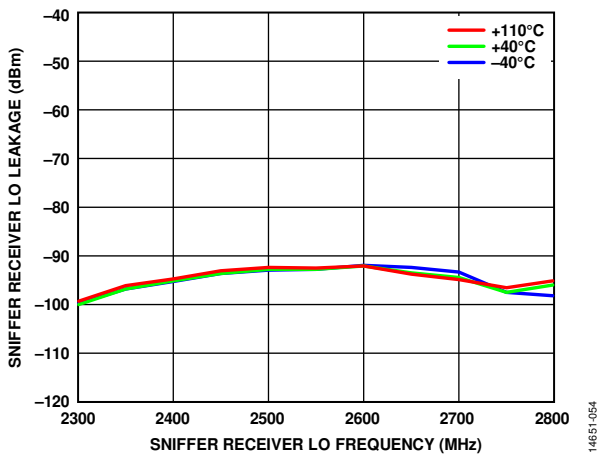

Figure 113. Sniffer Receiver LO Leakage vs. Sniffer Receiver LO Frequency, 0 dB Receiver Attenuation, 20 MHz RF Bandwidth, 30.72 MSPS Sample Rate

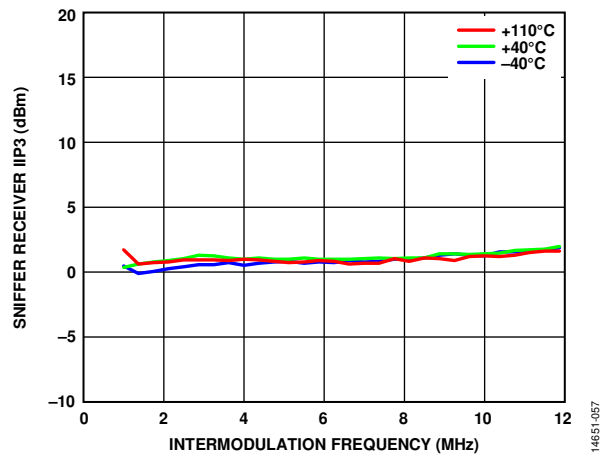

Figure 116. Sniffer Receiver IIP3 vs. Intermodulation Frequency ($f_2 - 2f_1$), 2600 MHz LO, 0 dB Attenuation, 20 MHz RF Bandwidth, 30.72 MSPS Sample Rate

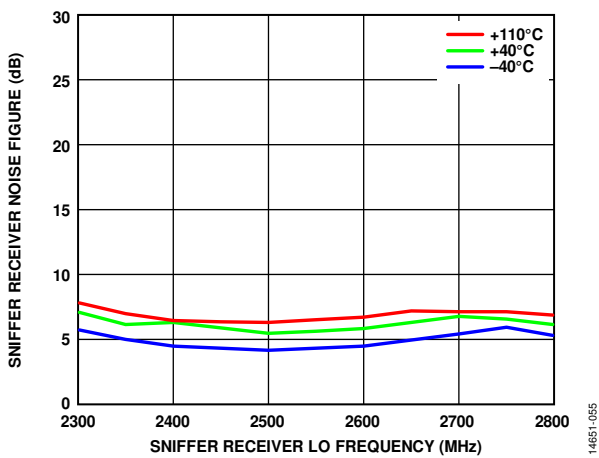

Figure 114. Sniffer Receiver Noise Figure vs. Sniffer Receiver LO Frequency, 0 dB Receiver Attenuation, 20 MHz RF Bandwidth, 30.72 MSPS Sample Rate, 20 MHz Integration Bandwidth

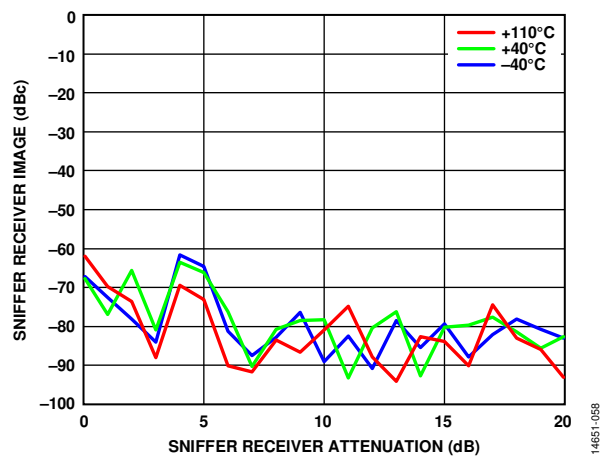

Figure 117. Sniffer Receiver Image vs. Sniffer Receiver Attenuation, 2600 MHz LO, CW Signal 1 MHz Offset, 20 MHz RF Bandwidth, 30.72 MSPS Sample Rate

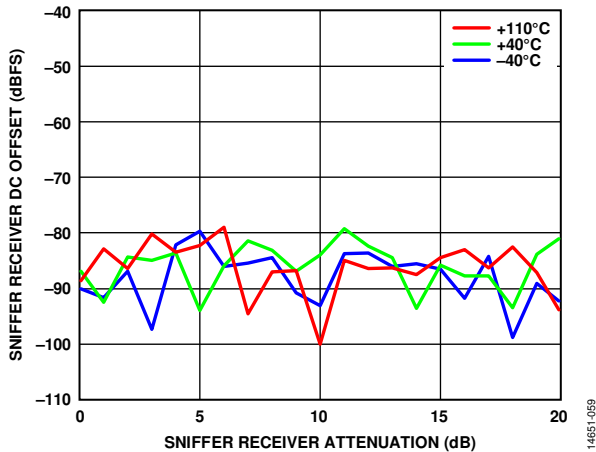

Figure 118. Sniffer Receiver DC Offset vs. Sniffer Receiver Attenuation, 2600 MHz LO, CW Signal 1 MHz Offset, -35 dBm at 0 dB Attenuation, Input Power Increasing Decibel for Decibel with Attenuation, 20 MHz RF Bandwidth, 30.72 MSPS Sample Rate

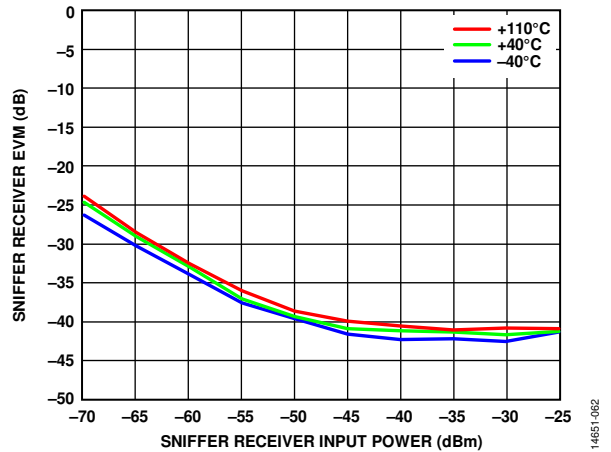

Figure 121. Sniffer Receiver EVM vs. Sniffer Receiver Input Power, 2600 MHz LO, 20 MHz RF Bandwidth, LTE 20 MHz Uplink Centered at DC, BTC Active, 30.72 MSPS Sample Rate

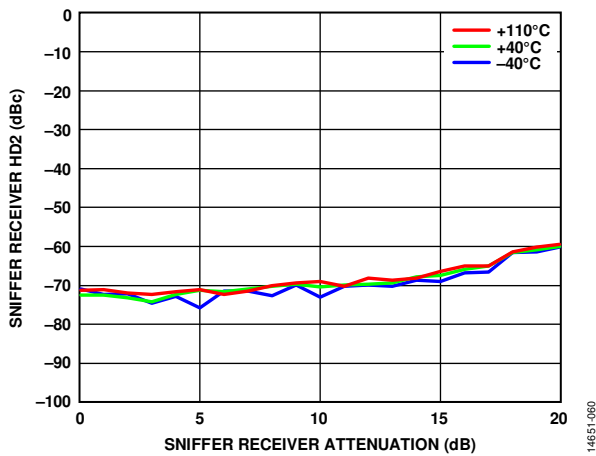

Figure 119. Sniffer Receiver HD2 vs. Sniffer Receiver Attenuation, 2600 MHz LO, CW Signal 1 MHz Offset, -35 dBm at 0 dB Attenuation, Input Power Increasing Decibel for Decibel with Attenuation, 20 MHz RF Bandwidth, 30.72 MSPS Sample Rate

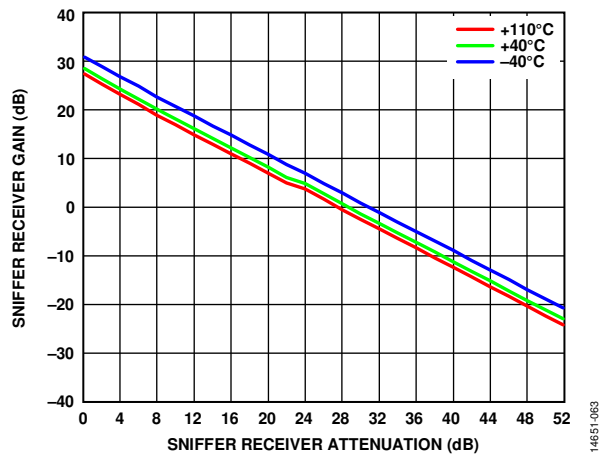

Figure 122. Sniffer Receiver Gain vs. Sniffer Receiver Attenuation, 2600 MHz LO, CW Signal 1 MHz Offset, 20 MHz RF Bandwidth, 30.72 MSPS Sample Rate

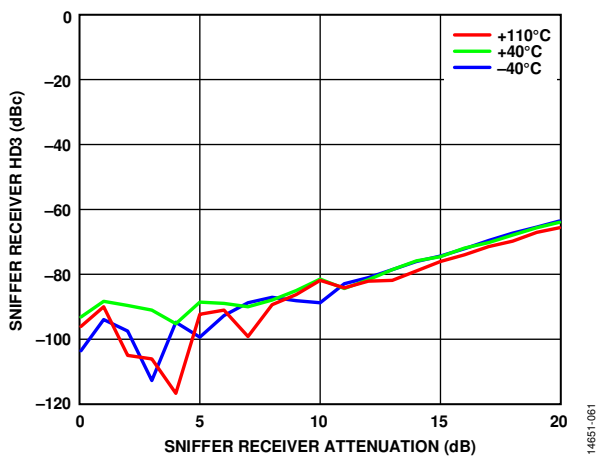
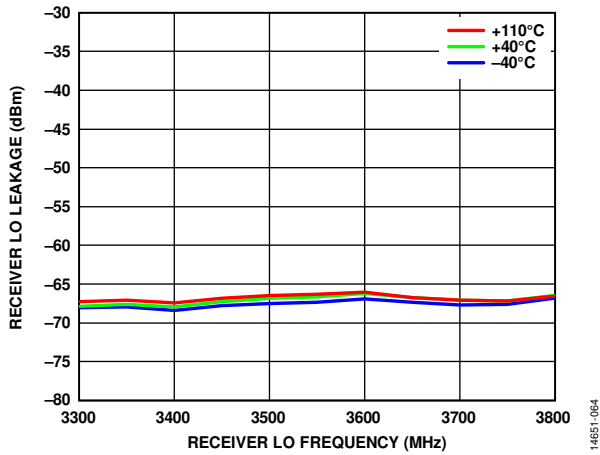

Figure 120. Sniffer Receiver HD3 vs. Sniffer Receiver Attenuation, 2600 MHz LO, CW Signal 1 MHz Offset, -35 dBm at 0 dB Attenuation, Input Power Increasing Decibel for Decibel with Attenuation, 20 MHz RF Bandwidth, 30.72 MSPS Sample Rate

3.5 GHz BAND



14651-064

Figure 123. Receiver Local Oscillator (LO) Leakage vs. Receiver LO Frequency, 0 dB Receiver Attenuation, 100 MHz RF Bandwidth, 153.6 MSPS Sample Rate

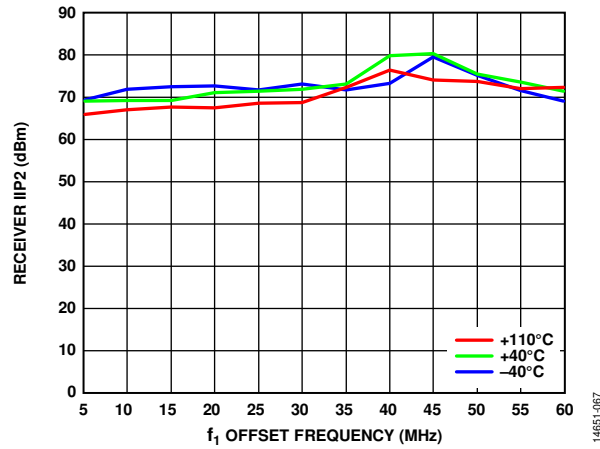

14651-067

Figure 126. Receiver IIP2 vs. f_1 Offset Frequency, 3500 MHz LO, 0 dB Attenuation, 100 MHz RF Bandwidth, $f_2 = f_1 + 1$ MHz, 153.6 MSPS Sample Rate

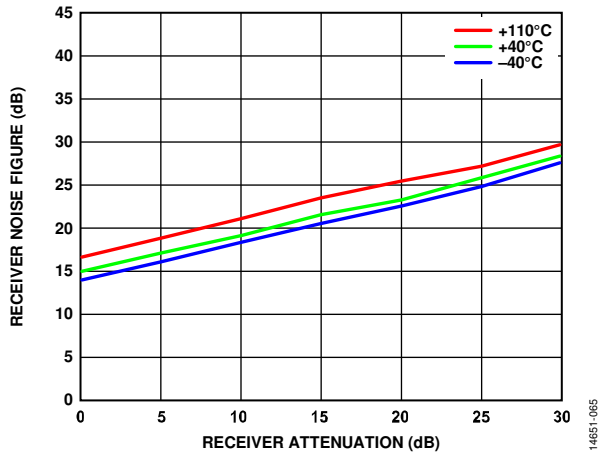

14651-065

Figure 124. Receiver Noise Figure vs. Receiver Attenuation, 3500 MHz LO, 100 MHz Bandwidth, 153.6 MSPS Sample Rate, 50 MHz Integration Bandwidth (Includes 1 dB Matching Circuit Loss)

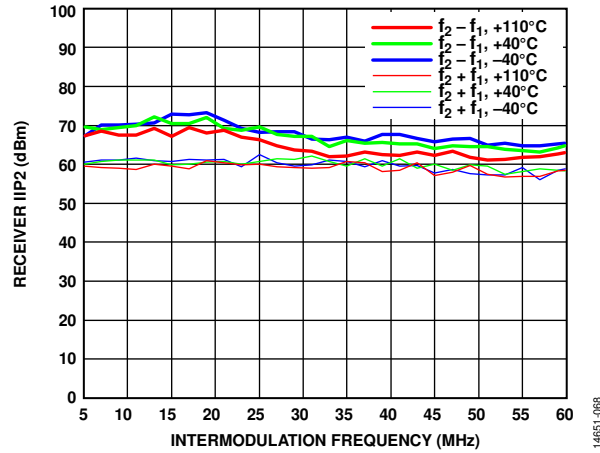

14651-068

Figure 127. Receiver IIP2 vs. Intermodulation Frequency, 3500 MHz LO, 0 dB Attenuation, 100 MHz RF Bandwidth, 153.6 MSPS Sample Rate

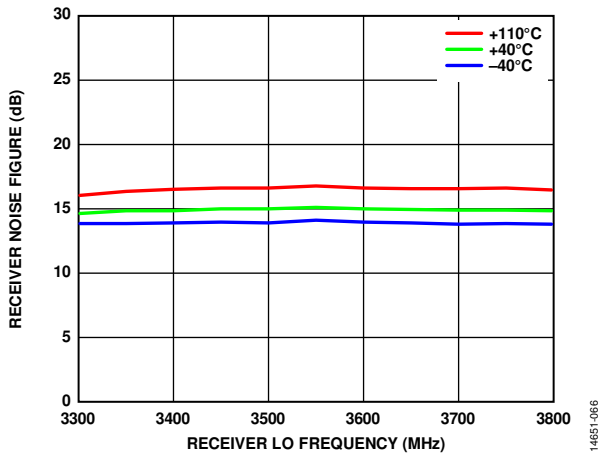

14651-066

Figure 125. Receiver Noise Figure vs. Receiver LO Frequency, 0 dB Receiver Attenuation, 100 MHz RF Bandwidth, 153.6 MSPS Sample Rate, 50 MHz Integration Bandwidth (Includes 1 dB Matching Circuit Loss)

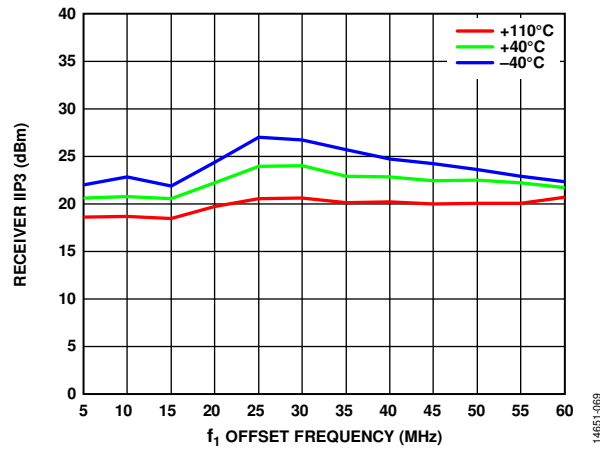

14651-069

Figure 128. Receiver IIP3 vs. f_1 Offset Frequency, 3500 MHz LO, 0 dB Attenuation, 100 MHz RF Bandwidth, $f_2 = 2f_1 + 1$ MHz, 153.6 MSPS Sample Rate

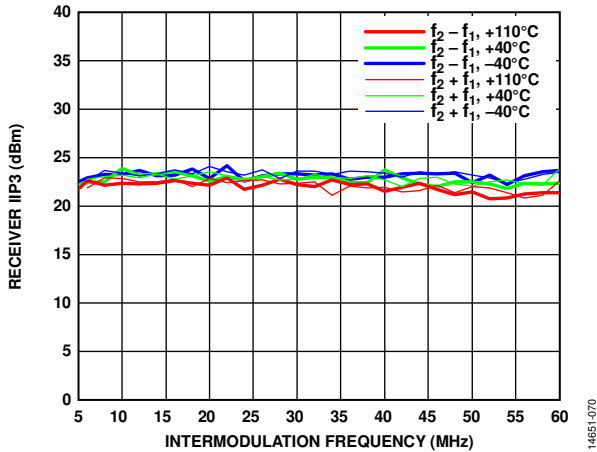

Figure 129. Receiver IIP3 vs. Intermodulation Frequency, 3500 MHz LO, 0 dB Attenuation, 100 MHz RF Bandwidth, 153.6 MSPS Sample Rate

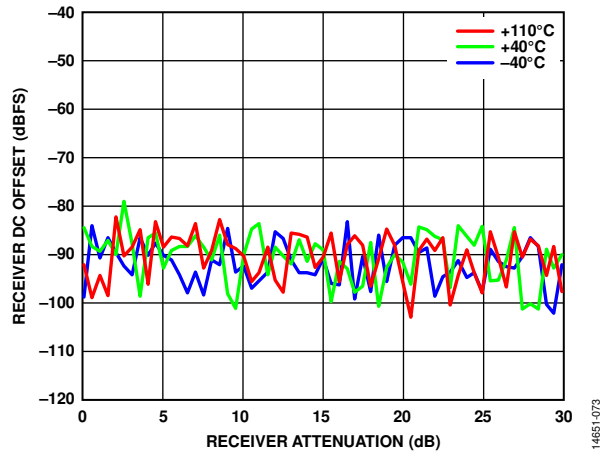

Figure 132. Receiver DC Offset vs. Receiver Attenuation, 3500 MHz LO, 100 MHz RF Bandwidth, 153.6 MSPS Sample Rate

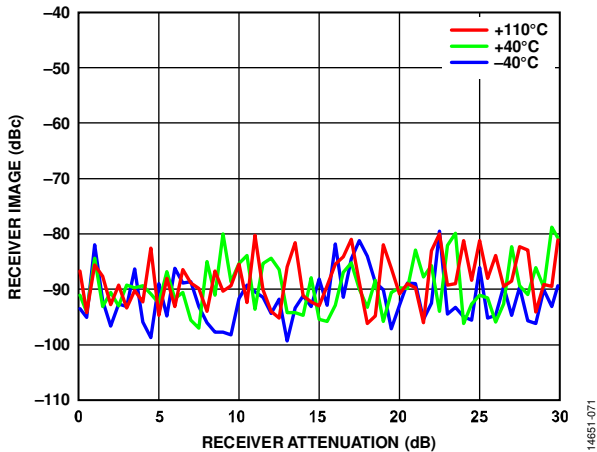

Figure 130. Receiver Image vs. Receiver Attenuation, 3500 MHz LO, Continuous Wave (CW) Signal 17 MHz Offset, 100 MHz RF Bandwidth, Background Tracking Calibration (BTC) Active, 153.6 MSPS Sample Rate

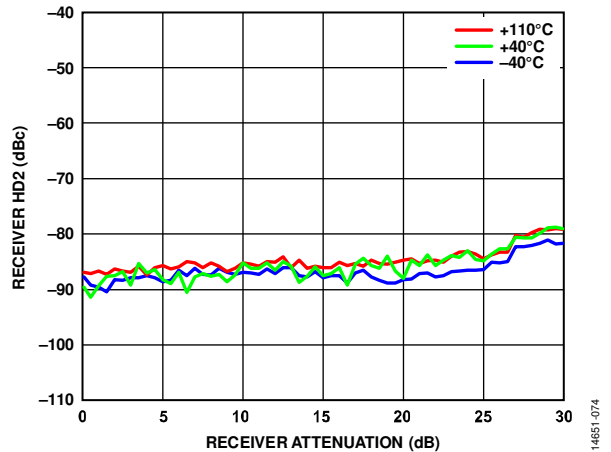

Figure 133. Receiver HD2 vs. Receiver Attenuation, 3500 MHz LO, CW Signal 17 MHz Offset, -14 dBm at 0 dB Attenuation, Input Power Increasing Decibel for Decibel with Attenuation, 100 MHz RF Bandwidth, 153.6 MSPS Sample Rate

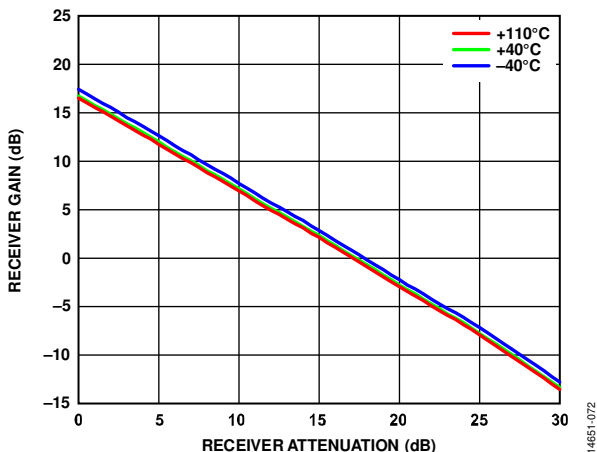

Figure 131. Receiver Gain vs. Receiver Attenuation, 3500 MHz LO, CW Signal 17 MHz Offset, 100 MHz RF Bandwidth, De-Embedded to Receiver Port, 153.6 MSPS Sample Rate

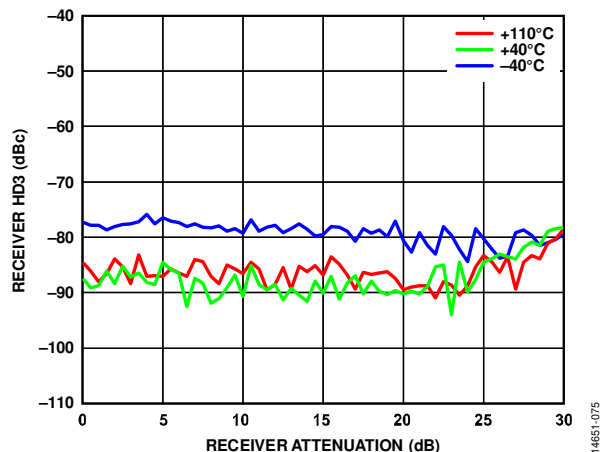

Figure 134. Receiver HD3 vs. Receiver Attenuation, 3500 MHz LO, CW Signal 17 MHz Offset, -14 dBm at 0 dB Attenuation, Input Power Increasing Decibel for Decibel with Attenuation, 100 MHz RF Bandwidth, 153.6 MSPS Sample Rate

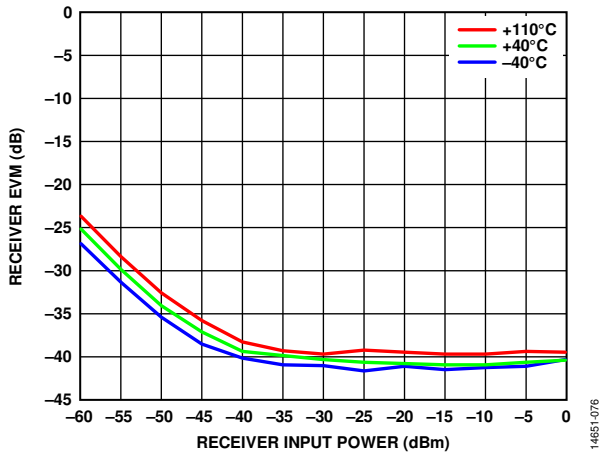

Figure 135. Receiver Error Vector Magnitude (EVM) vs. Receiver Input Power, 3600 MHz LO, 100 MHz RF Bandwidth, LTE 20 MHz Uplink Centered at DC, BTC Active, 153.6 MSPS Sample Rate

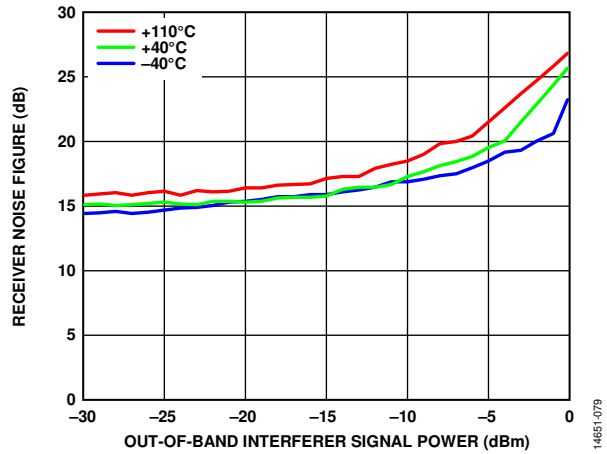

Figure 138. Receiver Noise Figure vs. Out of Band Interferer Signal Power, 3614 MHz LO, 3665 MHz CW Interferer, Noise Figure Integrated over 7 MHz to 10 MHz

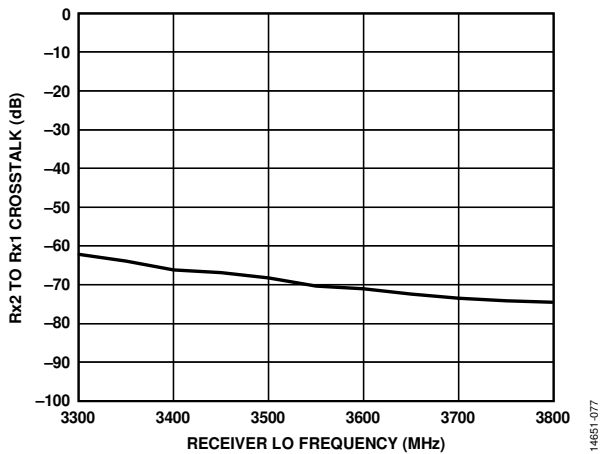

Figure 136. Rx2 to Rx1 Crosstalk vs. Receiver LO Frequency, 100 MHz RF Bandwidth, CW Tone 3 MHz Offset from LO

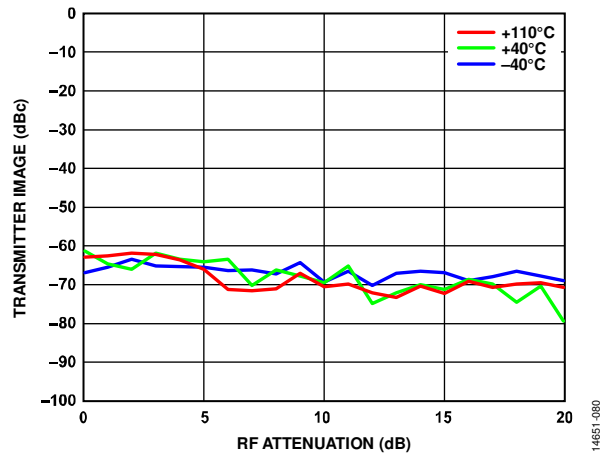

Figure 139. Transmitter Image vs. RF Attenuation, 100 MHz RF Bandwidth, 3550 MHz LO, Transmitter Quadrature Error Correction (QEC) Tracking Run with Two 20 MHz, LTE Downlink Carriers, Then Image Measured with CW 10 MHz Offset from LO, 6 dB Digital Backoff, 307.2 MSPS Sample Rate

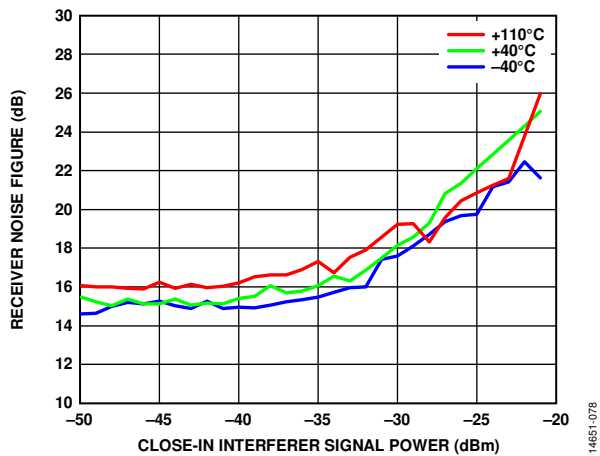

Figure 137. Receiver Noise Figure vs. Close-In Interferer Signal Power, 3614 MHz LO, 3625 MHz CW Interferer, Noise Figure Integrated over 7 MHz to 10 MHz, 100 MHz RF Bandwidth

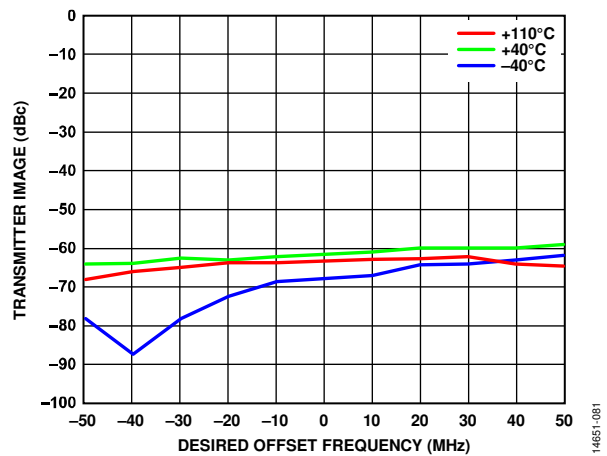

Figure 140. Transmitter Image vs. Desired Offset Frequency, 100 MHz RF Bandwidth, 3550 MHz LO, 0 dB RF Attenuation, Transmitter QEC Tracking Run with Two 20 MHz LTE Downlink Carriers, Then Image Measured with CW Signal, 6 dB Digital Backoff, 307.2 MSPS Sample Rate

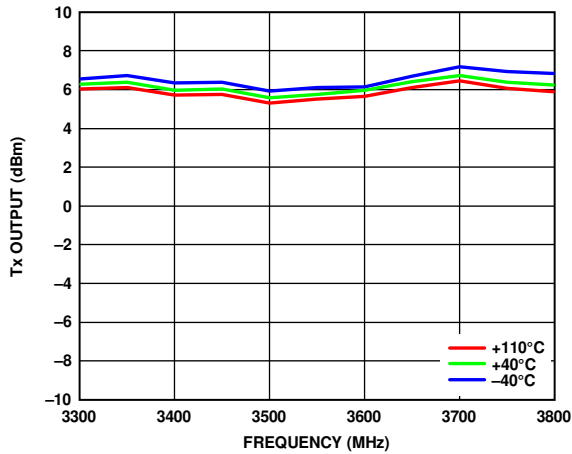

Figure 141. Tx Output Power, Transmitter QEC and External LO Leakage Active, 5 MHz CW Offset Signal, 1 MHz Resolution Bandwidth, 307.2 MSPS Sample Rate

14651-082

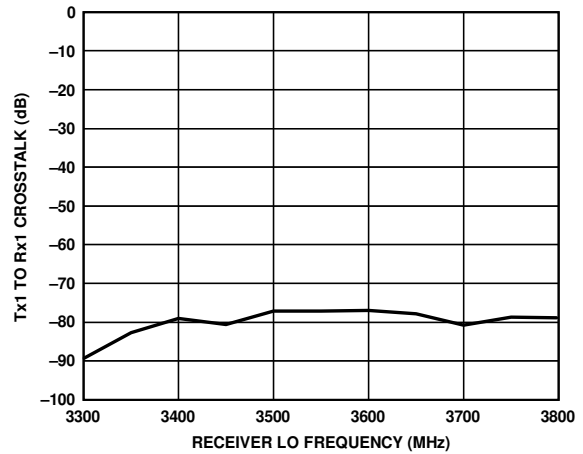

Figure 144. Tx1 to Rx1 Crosstalk vs. Receiver LO Frequency, 100 MHz Receiver RF Bandwidth, 100 MHz Transmitter RF Bandwidth, CW Signal 3 MHz Offset from LO

14651-085

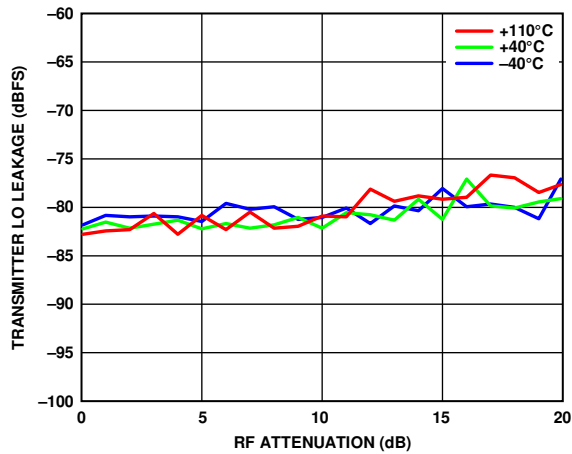

Figure 142. Transmitter LO Leakage vs. RF Attenuation, 3550 MHz LO, Transmitter QEC and External LO Leakage Tracking Active, CW Signal 10 MHz Offset from LO, 6 dB Digital Backoff, 1 MHz Measurement Bandwidth (If Input Power to ORx Channel Is Not Held Constant, Performance Degrades as Shown in This Plot)

14651-083

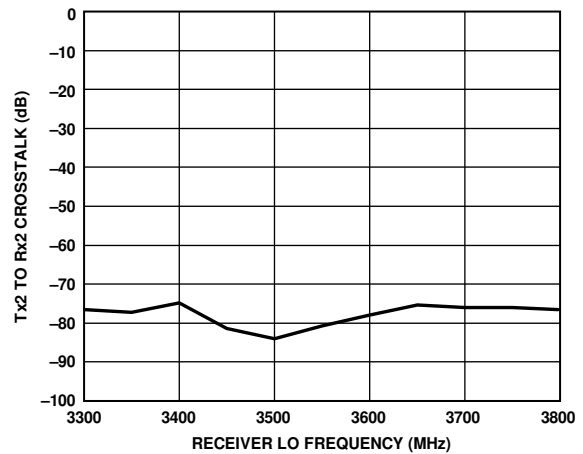

Figure 145. Tx2 to Rx2 Crosstalk vs. Receiver LO Frequency, 100 MHz Receiver RF Bandwidth, 100 MHz Transmitter RF Bandwidth, CW Signal 3 MHz Offset from LO

14651-086

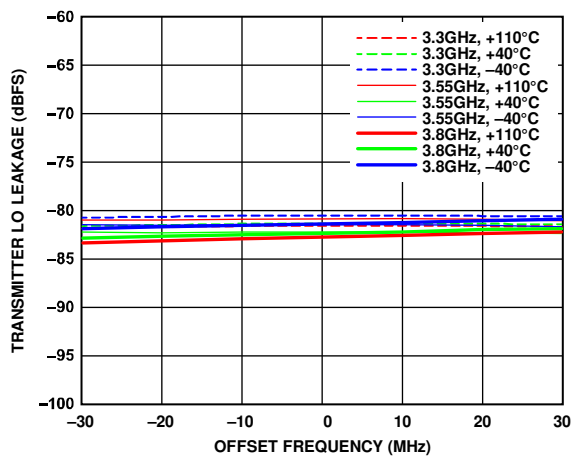

Figure 143. Transmitter LO Leakage vs. Offset Frequency, Transmitter QEC and External LO Leakage Tracking Active, 6 dB Digital Backoff, 1 MHz Measurement Bandwidth

14651-084

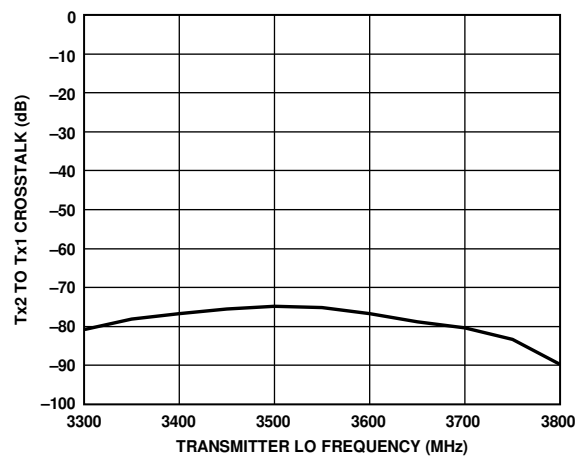

Figure 146. Tx2 to Tx1 Crosstalk vs. Transmitter LO Frequency, 100 MHz RF Bandwidth, CW Signal 3 MHz Offset from LO

14651-087

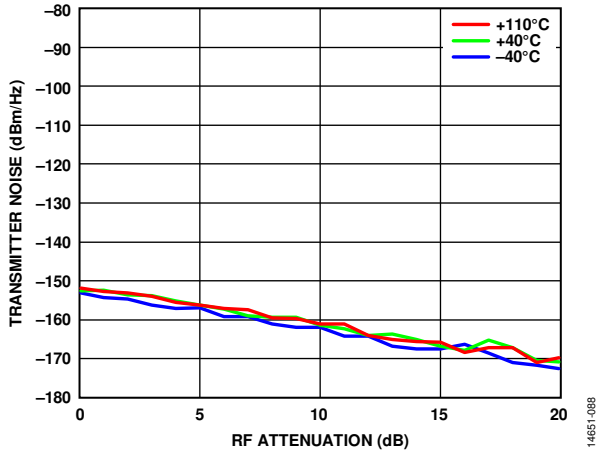

Figure 147. Transmitter Noise vs. RF Attenuation, 3500 MHz LO, 100 MHz Offset Frequency, Zeros Input Data

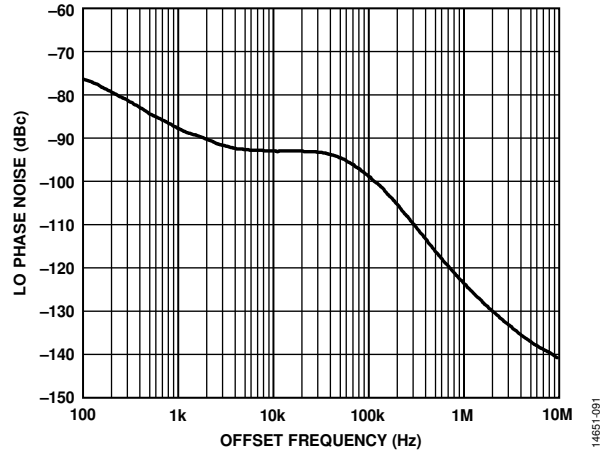

Figure 150. LO Phase Noise vs. Offset Frequency, 3 dB Digital Backoff, 3500 MHz LO

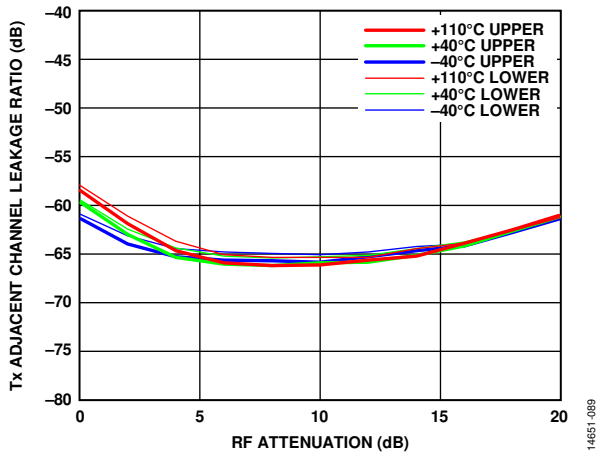

Figure 148. Tx Adjacent Channel Leakage Ratio vs. RF Attenuation, 3500 MHz LO, 100 MHz RF Bandwidth, Four-Carrier W-CDMA Desired Signal, 2 dB Digital Backoff, Transmitter QEC and LO Leakage Tracking Active

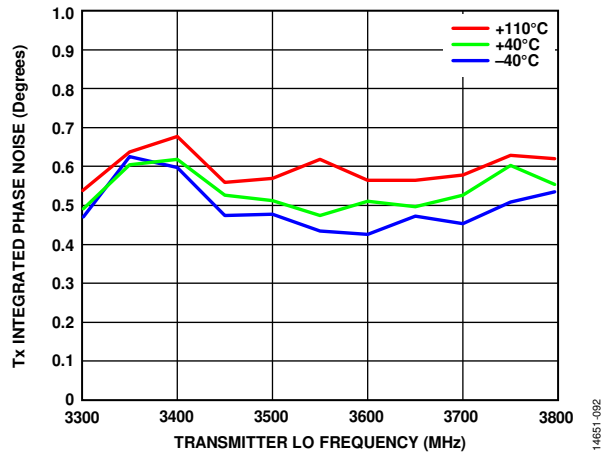

Figure 151. Tx Integrated Phase Noise vs. Transmitter LO Frequency, 100 MHz RF Bandwidth, CW 20 MHz Offset from LO, 3 dB Digital Backoff

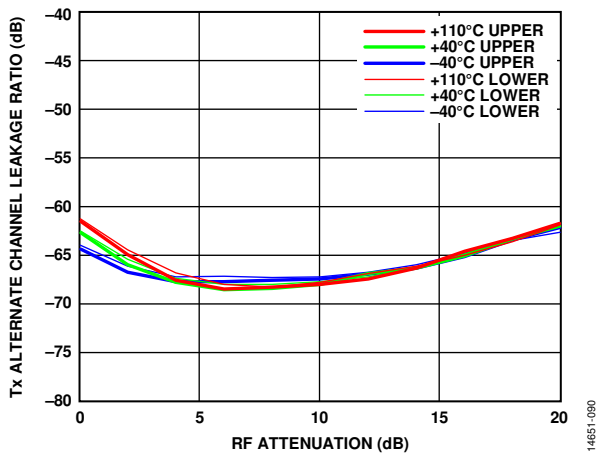

Figure 149. Tx Alternate Channel Leakage Ratio vs. RF Attenuation, 3500 MHz LO, 100 MHz RF Bandwidth, Four-Carrier W-CDMA Desired Signal, 2 dB Digital Backoff, Transmitter QEC and LO Leakage Tracking Active

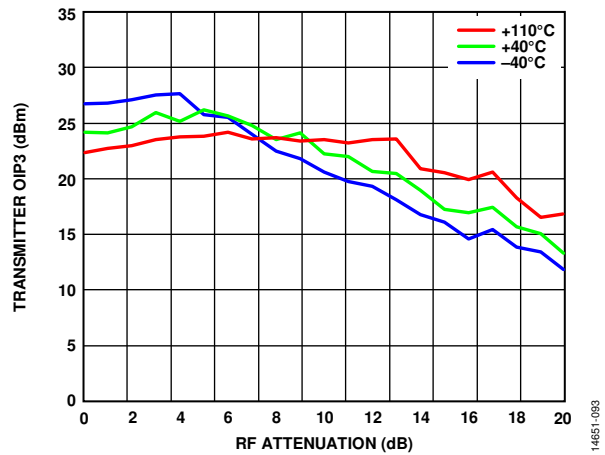

Figure 152. Transmitter OIP3 vs. RF Attenuation, 3500 MHz LO, 100 MHz RF Bandwidth, $f_1 = 20$ MHz, $f_2 = 21$ MHz, 3 dB Digital Backoff, 307.2 MSPS Sample Rate

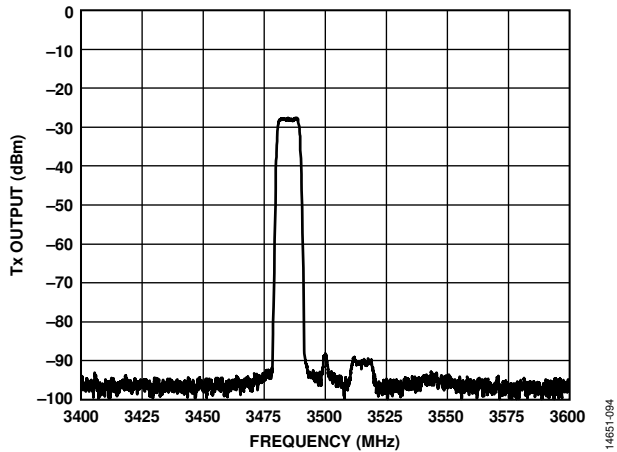

Figure 153. Tx Output Power Spectrum, 2 dB Digital and 3 dB RF Backoff, 100 MHz RF Bandwidth, Transmitter QEC and Internal LO Leakage Active, LTE 10 MHz Signal, 3500 MHz LO, 1 MHz Resolution Bandwidth, 307.2 MSPS Sample Rate

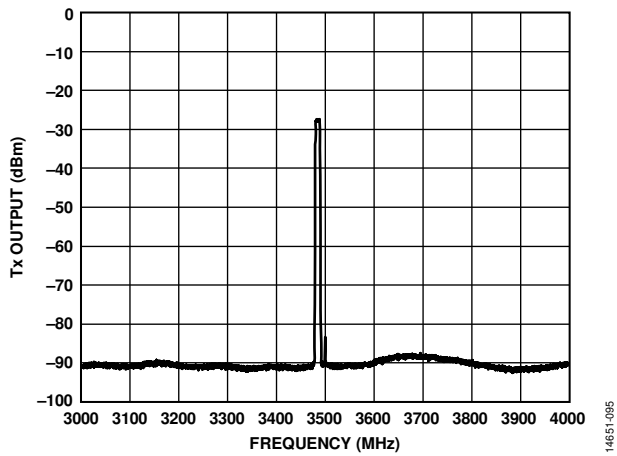

Figure 154. Tx Output Power Spectrum, 2 dB Digital and 3 dB RF Backoff, 100 MHz RF Bandwidth, Transmitter QEC and Internal LO Leakage Active, LTE 10 MHz Signal, 3500 MHz LO, 1 MHz Resolution Bandwidth, 307.2 MSPS Sample Rate (Noise Floor Includes Test Equipment Response)

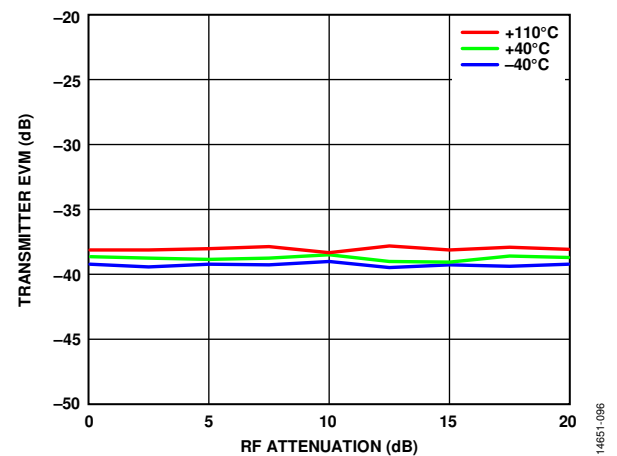

Figure 155. Transmitter EVM vs. RF Attenuation, 3500 MHz LO, Transmitter LO Leakage, and Transmitter QEC Tracking Active, 100 MHz RF Bandwidth, LTE 20 MHz Downlink Signal, 307.2 MSPS Sample Rate

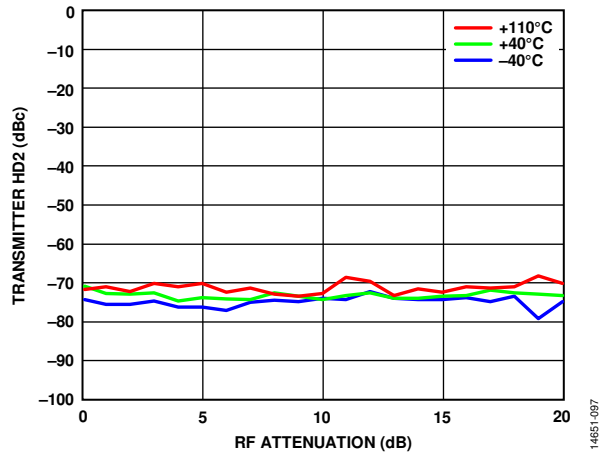

Figure 156. Transmitter HD2 vs. RF Attenuation, 3500 MHz LO, 3505 MHz CW Desired Signal, 100 MHz RF Bandwidth, 307.2 MSPS Sample Rate

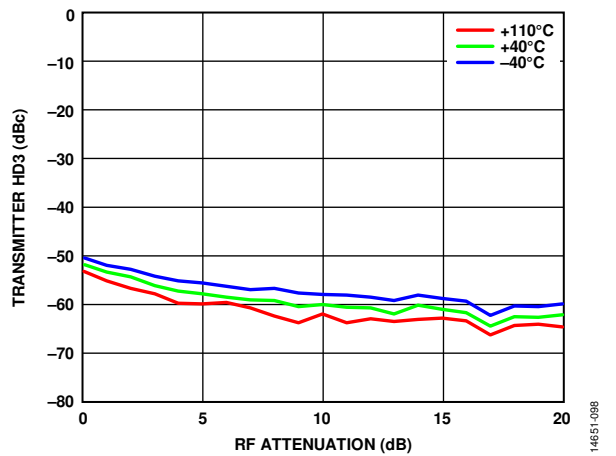

Figure 157. Transmitter HD3 vs. RF Attenuation, 3500 MHz LO, 3505 MHz CW Desired Signal, 100 MHz RF Bandwidth, 307.2 MSPS Sample Rate

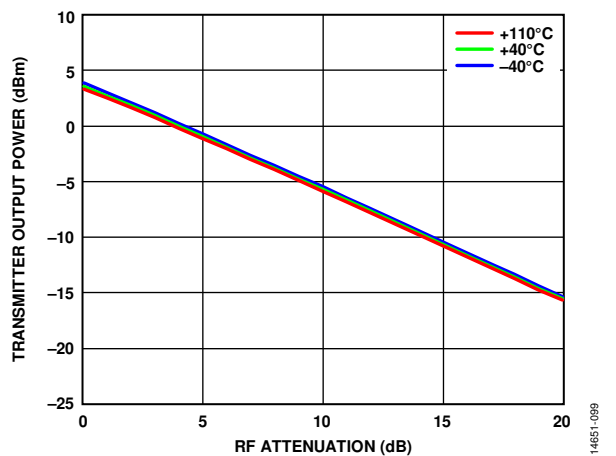

Figure 158. Transmitter Output Power vs. RF Attenuation, 3500 MHz LO, 3505 MHz CW Desired Signal, 100 MHz RF Bandwidth, 2 dB Digital Backoff, 307.2 MSPS Sample Rate

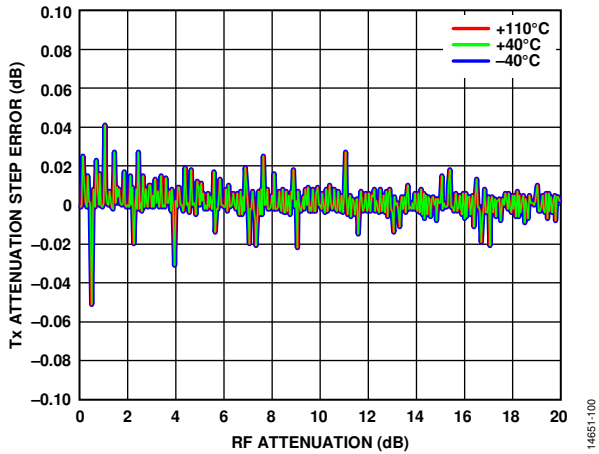

Figure 159. Tx Attenuation Step Error vs. RF Attenuation, 3500 MHz LO, 3510 MHz CW Desired Signal, 100 MHz RF Bandwidth, De-Embedded to Transmitter Port, 307.2 MSPS Sample Rate

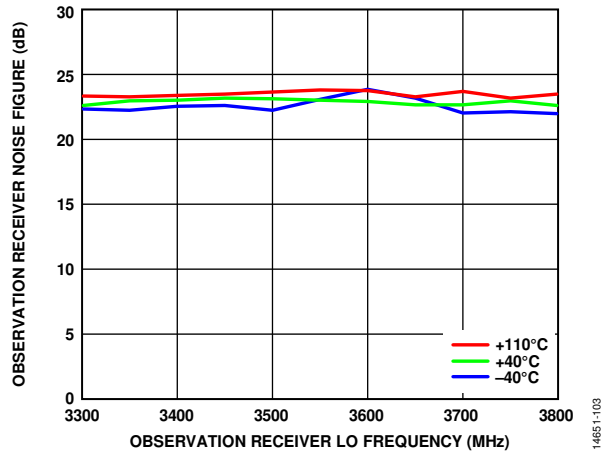

Figure 162. Observation Receiver Noise Figure vs. Observation Receiver LO Frequency, 0 dB Receiver Attenuation, 240 MHz RF Bandwidth, 307.2 MSPS Sample Rate, 120 MHz Integration Bandwidth

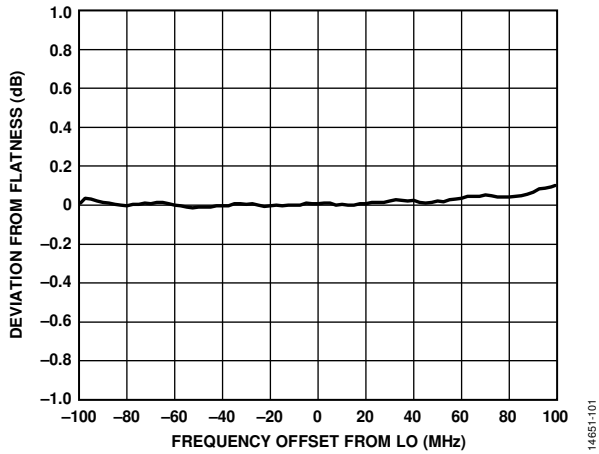

Figure 160. Transmitter Frequency Response Deviation from Flatness vs. Frequency Offset from LO, 3500 MHz LO, 100 MHz RF Bandwidth, 6 dB Digital Backoff, 307.2 MSPS Sample Rate

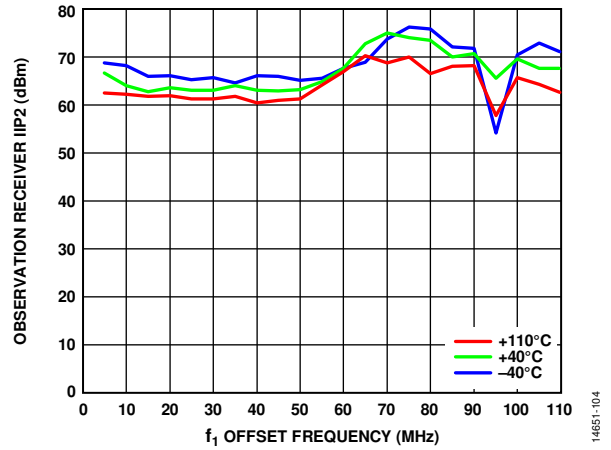

Figure 163. Observation Receiver IIP2 vs. f_1 Offset Frequency, 3600 MHz LO, 0 dB Attenuation, 240 MHz RF Bandwidth, $f_2 = f_1 + 1$ MHz, 307.2 MSPS Sample Rate

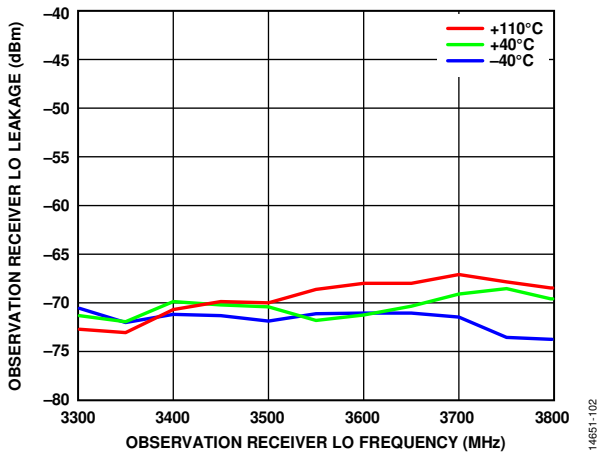

Figure 161. Observation Receiver LO Leakage vs. Observation Receiver LO Frequency, 0 dB Receiver Attenuation, 240 MHz RF Bandwidth, 307.2 MSPS Sample Rate

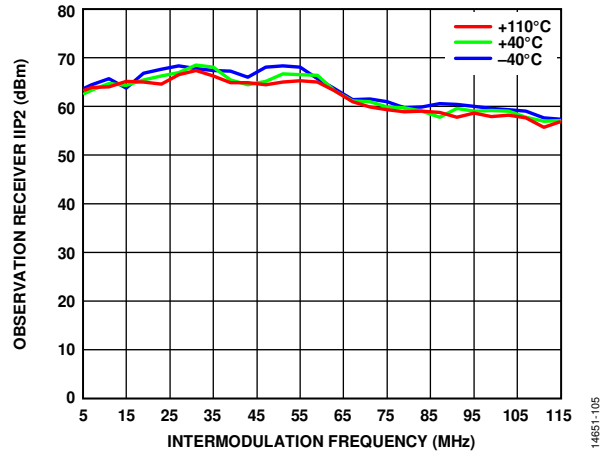

Figure 164. Observation Receiver IIP2 vs. Intermodulation Frequency ($f_2 - f_1$), 3500 MHz LO, 0 dB Attenuation, 240 MHz RF Bandwidth, 307.2 MSPS Sample Rate

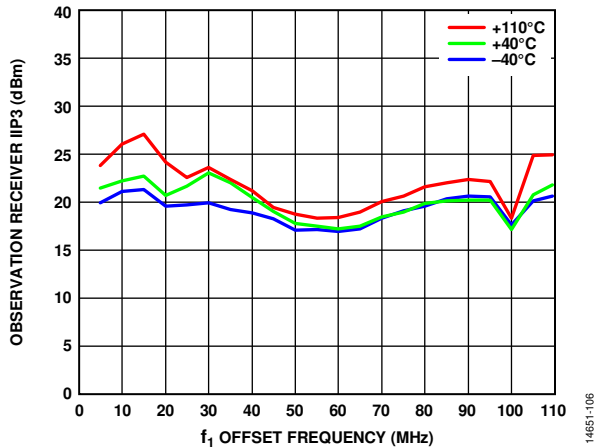

Figure 165. Observation Receiver IIP3 vs. f_1 Offset Frequency, 3600 MHz LO, 0 dB Attenuation, 240 MHz RF Bandwidth, $f_2 = 2f_1 + 1$ MHz, 307.2 MSPS Sample Rate

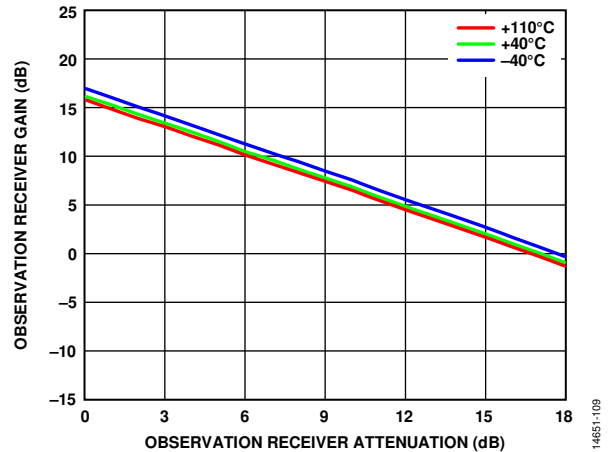

Figure 168. Observation Receiver Gain vs. Observation Receiver Attenuation, 3500 MHz LO, CW Signal 25 MHz Offset, 240 MHz RF Bandwidth, De-Embedded to Receiver Port, 307.2 MSPS Sample Rate

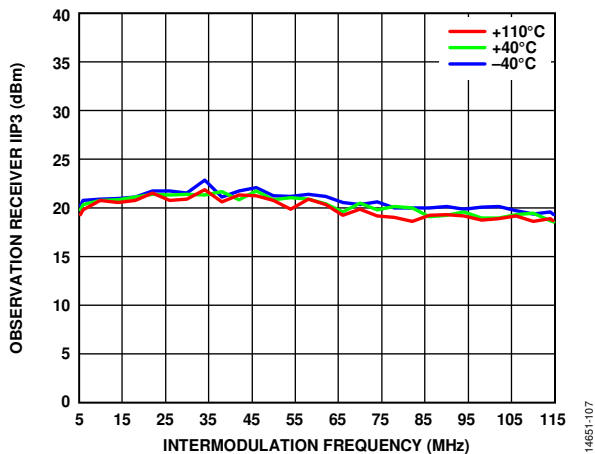

Figure 166. Observation Receiver IIP3 vs. Intermodulation Frequency ($f_2 - 2f_1$), 3500 MHz LO, 0 dB Attenuation, 240 MHz RF Bandwidth, 307.2 MSPS Sample Rate

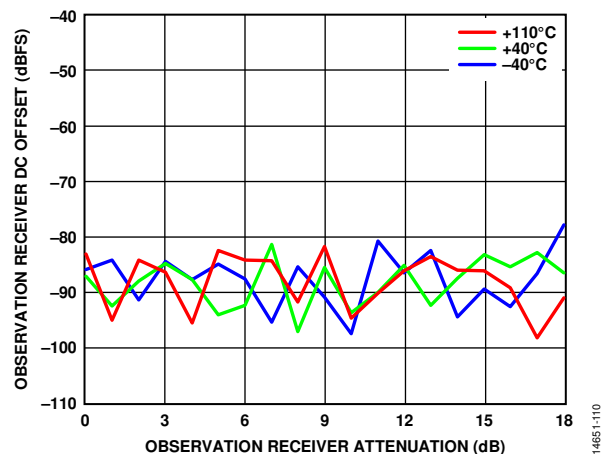

Figure 169. Observation Receiver DC Offset vs. Observation Receiver Attenuation, 3500 MHz LO, 240 MHz RF Bandwidth, 307.2 MSPS Sample Rate

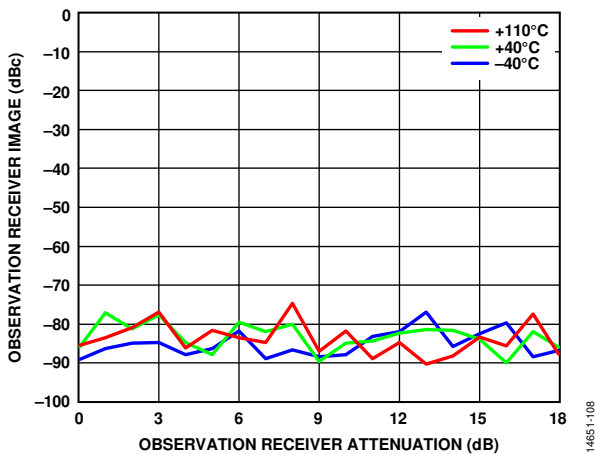

Figure 167. Observation Receiver Image vs. Observation Receiver Attenuation, 3500 MHz LO, CW Signal 25 MHz Offset, 240 MHz RF Bandwidth, BTC Active, 307.2 MSPS Sample Rate

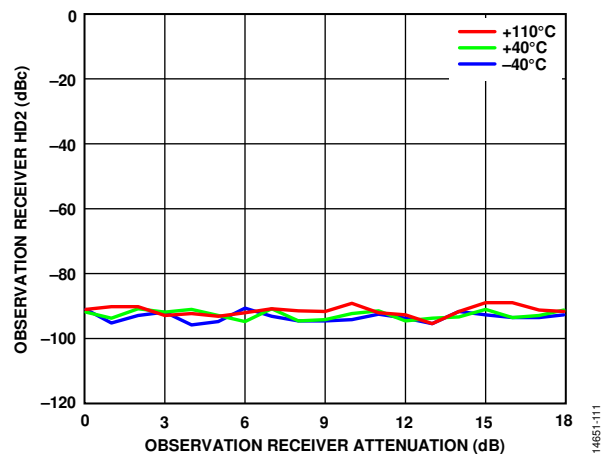

Figure 170. Observation Receiver HD2 vs. Observation Receiver Attenuation, 3500 MHz LO, CW Signal 25 MHz Offset, -20 dBm at 0 dB Attenuation, Input Power Increasing Decibel for Decibel with Attenuation, 240 MHz RF Bandwidth, 307.2 MSPS Sample Rate

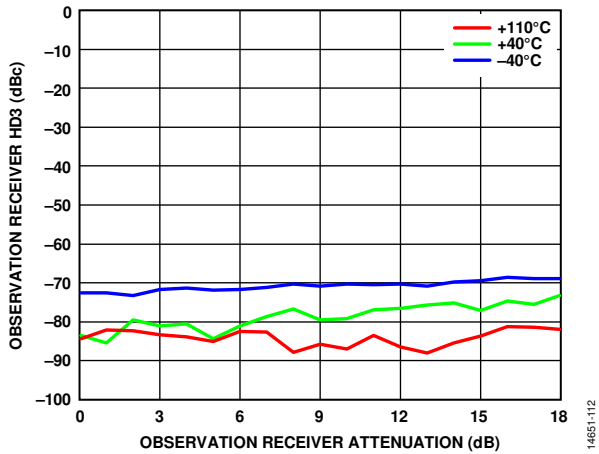

Figure 171. Observation Receiver HD3 vs. Observation Receiver Attenuation, 3500 MHz LO, CW Signal 25 MHz Offset, -20 dBm at 0 dB Attenuation, Input Power Increasing Decibel for Decibel with Attenuation, 240 MHz RF Bandwidth, 307.2 MSPS Sample Rate

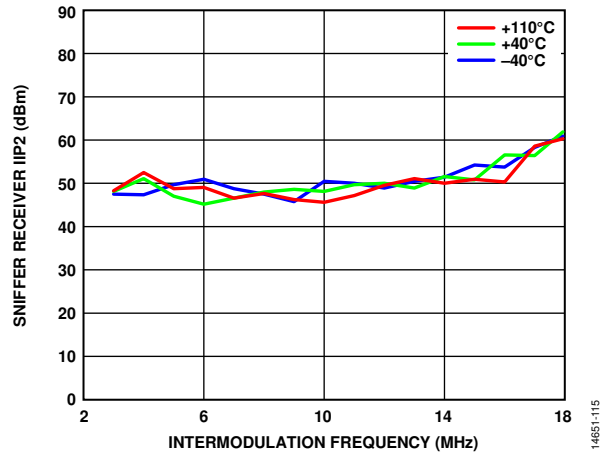

Figure 174. Sniffer Receiver IIP2 vs. Intermodulation Frequency ($f_2 - f_1$), 3500 MHz LO, 0 dB Attenuation, 20 MHz RF Bandwidth, 38.4 MSPS Sample Rate

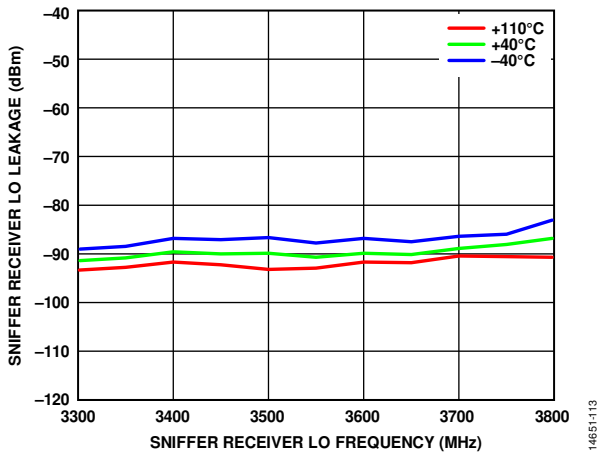

Figure 172. Sniffer Receiver LO Leakage vs. Sniffer Receiver LO Frequency, 0 dB Receiver Attenuation, 20 MHz RF Bandwidth, 38.4 MSPS Sample Rate

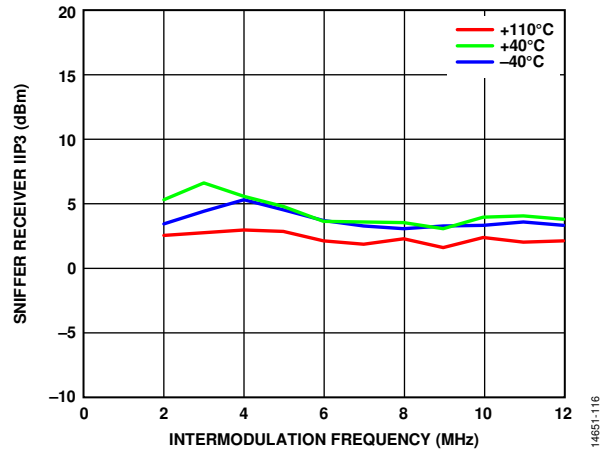

Figure 175. Sniffer Receiver IIP3 vs. Intermodulation Frequency ($f_2 - 2f_1$), 3500 MHz LO, 0 dB Attenuation, 20 MHz RF Bandwidth, 38.4 MSPS Sample Rate

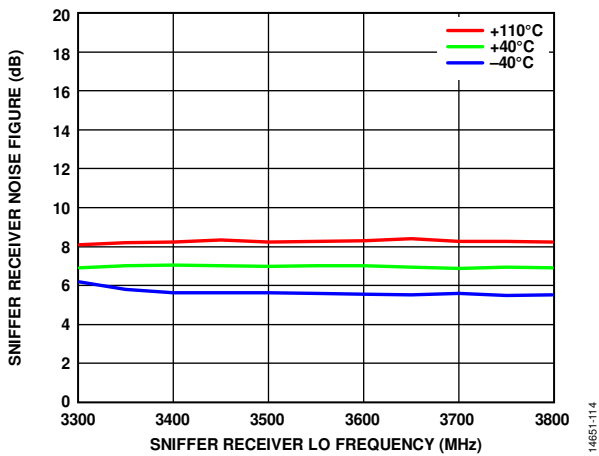

Figure 173. Sniffer Receiver Noise Figure vs. Sniffer Receiver LO Frequency, 0 dB Receiver Attenuation, 20 MHz RF Bandwidth, 38.4 MSPS Sample Rate, 10 MHz Integration Bandwidth

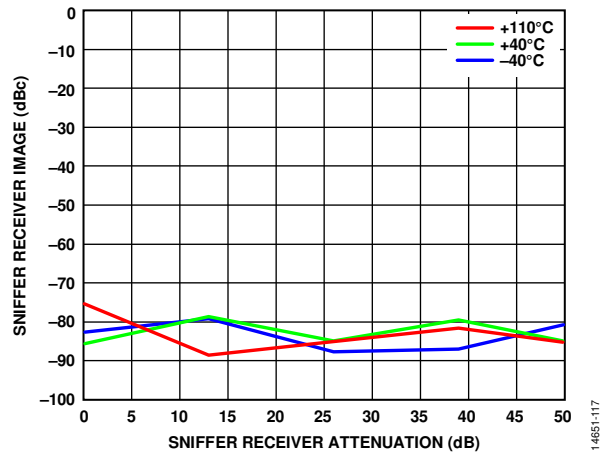

Figure 176. Sniffer Receiver Image vs. Sniffer Receiver Attenuation, 3500 MHz LO, CW Signal 5 MHz Offset, 20 MHz RF Bandwidth, 38.4 MSPS Sample Rate

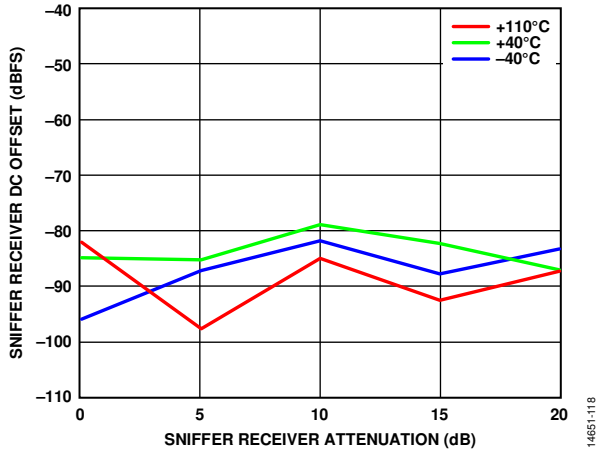

Figure 177. Sniffer Receiver DC Offset vs. Sniffer Receiver Attenuation, 3500 MHz LO, CW Signal 5 MHz Offset, -35 dBm at 0 dB Attenuation, Input Power Increasing Decibel for Decibel with Attenuation, 20 MHz RF Bandwidth, 38.4 MSPS Sample Rate

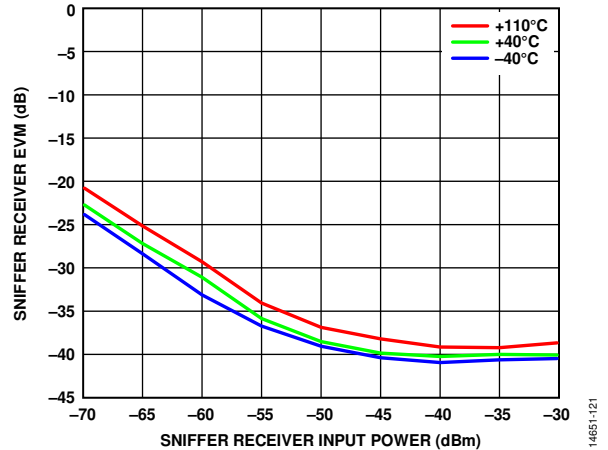

Figure 180. Sniffer Receiver EVM vs. Sniffer Receiver Input Power, 3600 MHz LO, 20 MHz RF Bandwidth, LTE 20 MHz Uplink Centered at DC, BTC Active, 38.4 MSPS Sample Rate

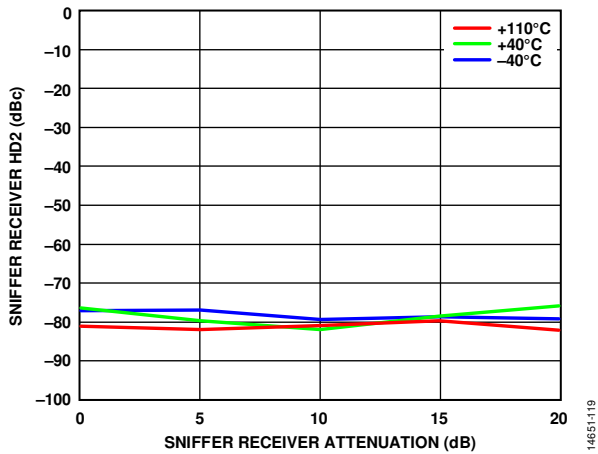

Figure 178. Sniffer Receiver HD2 vs. Sniffer Receiver Attenuation, 3500 MHz LO, CW Signal 5 MHz Offset, -35 dBm at 0 dB Attenuation, Input Power Increasing Decibel for Decibel with Attenuation, 20 MHz RF Bandwidth, 38.4 MSPS Sample Rate

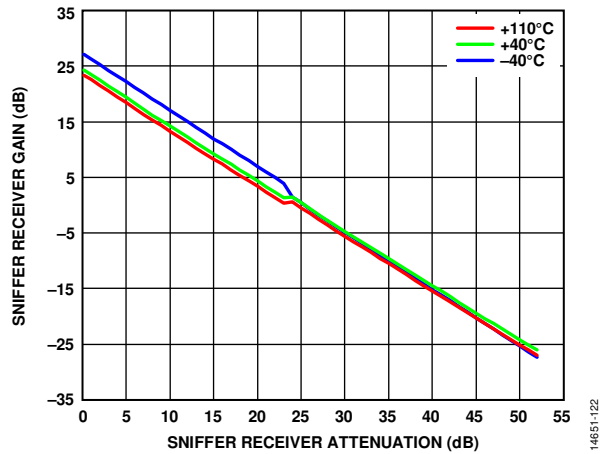

Figure 181. Sniffer Receiver Gain vs. Sniffer Receiver Attenuation, 3600 MHz LO, CW Signal 5 MHz Offset, 20 MHz RF Bandwidth, De-Embedded to Receiver Port, 38.4 MSPS Sample Rate

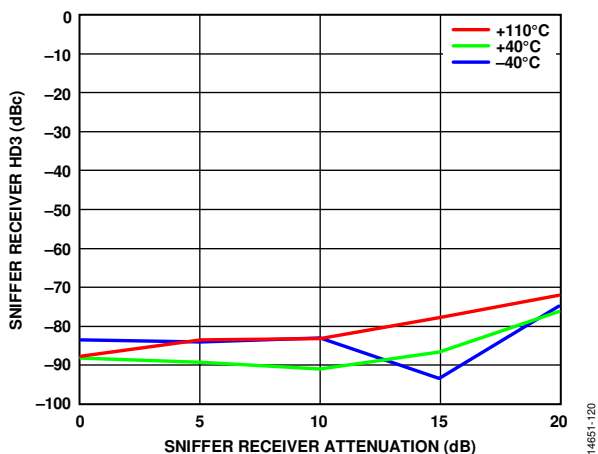

Figure 179. Sniffer Receiver HD3 vs. Sniffer Receiver Attenuation, 3500 MHz LO, CW Signal 5 MHz Offset, -35 dBm at 0 dB Attenuation, Input Power Increasing Decibel for Decibel with Attenuation, 20 MHz RF Bandwidth, 38.4 MSPS Sample Rate

5.5 GHz BAND

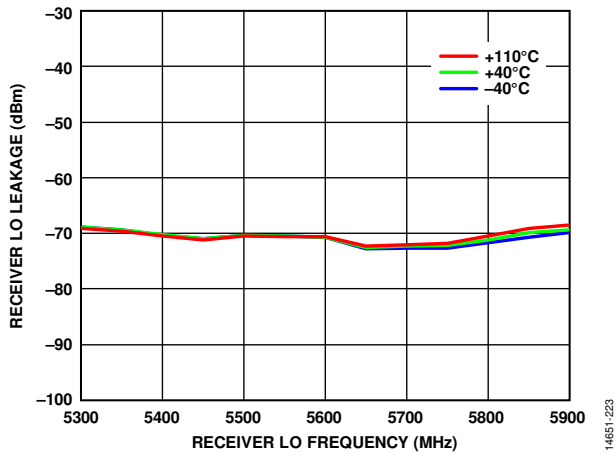

Figure 182. Receiver Local Oscillator (LO) Leakage vs. Receiver LO Frequency, 0 dB Receiver Attenuation, 100 MHz RF Bandwidth, 122.88 MSPS Sample Rate

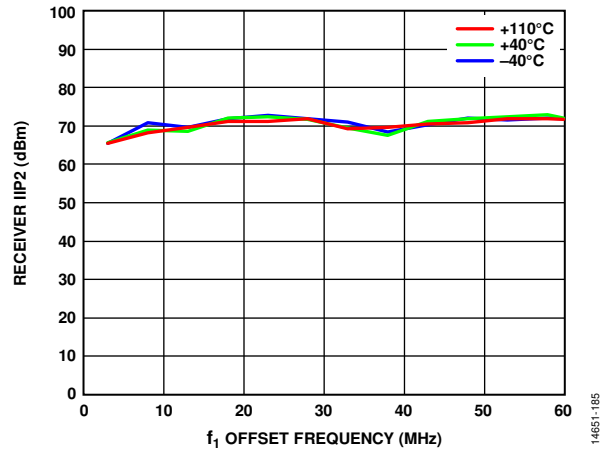

Figure 185. Receiver IIP2 vs. f_1 Offset Frequency, 5600 MHz LO, 0 dB Attenuation, 100 MHz RF Bandwidth, $f_2 = f_1 + 1$ MHz, 122.88 MSPS Sample Rate

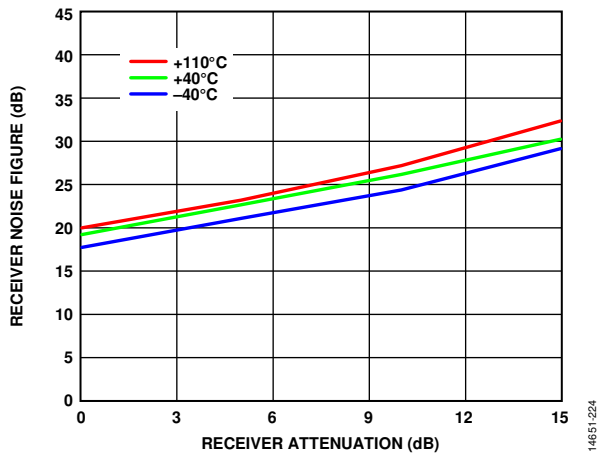

Figure 183. Receiver Noise Figure vs. Receiver Attenuation, 5600 MHz LO, 100 MHz Bandwidth, 122.88 MSPS Sample Rate, 50 MHz Integration Bandwidth (Includes 1.2 dB Matching Circuit Loss)

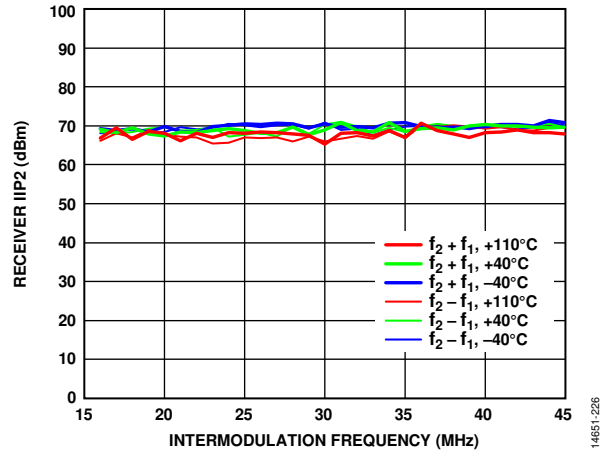

Figure 186. Receiver IIP2 vs. Intermodulation Frequency, 5600 MHz LO, 0 dB Attenuation, 100 MHz RF Bandwidth, 122.88 MSPS Sample Rate

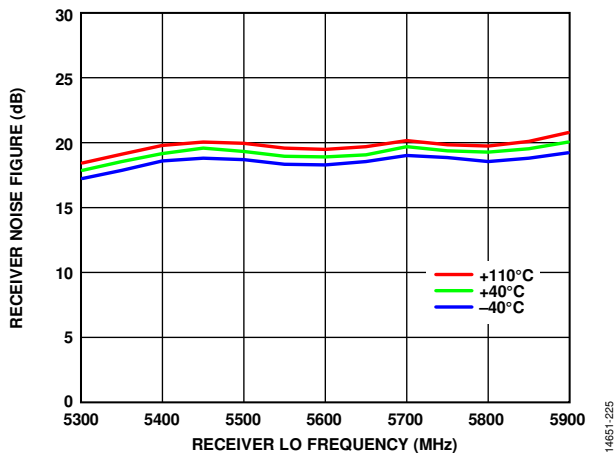

Figure 184. Receiver Noise Figure vs. Receiver LO Frequency, 0 dB Receiver Attenuation, 100 MHz RF Bandwidth, 122.88 MSPS Sample Rate, 50 MHz Integration Bandwidth (Includes 1.2 dB Matching Circuit Loss)

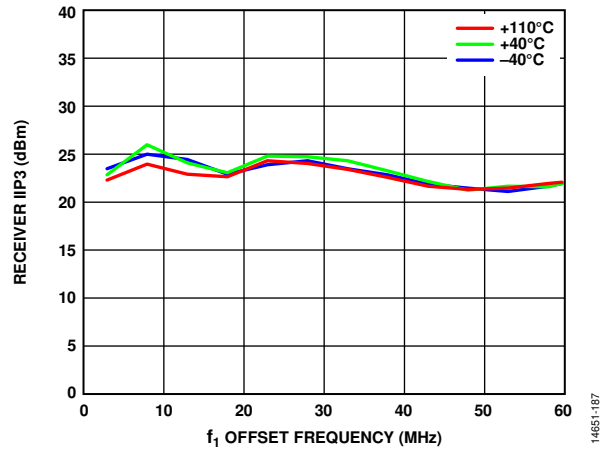

Figure 187. Receiver IIP3 vs. f_1 Offset Frequency, 5600 MHz LO, 0 dB Attenuation, 100 MHz RF Bandwidth, $f_2 = 2 f_1 + 2$ MHz, 122.88 MSPS Sample Rate

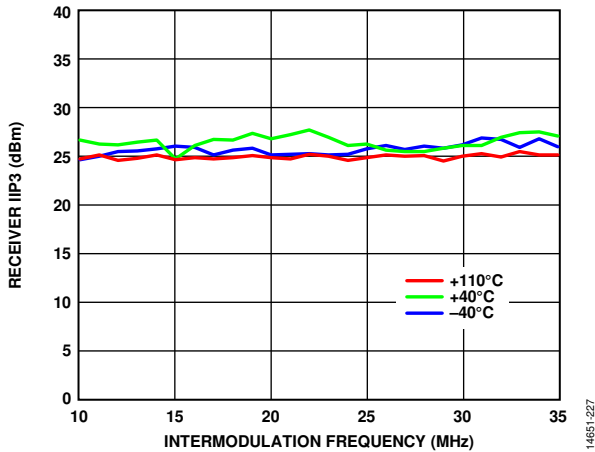

Figure 188. Receiver IIP3 vs. Intermodulation Frequency, 5600 MHz LO, 0 dB Attenuation, 100 MHz RF Bandwidth, 122.88 MSPS Sample Rate

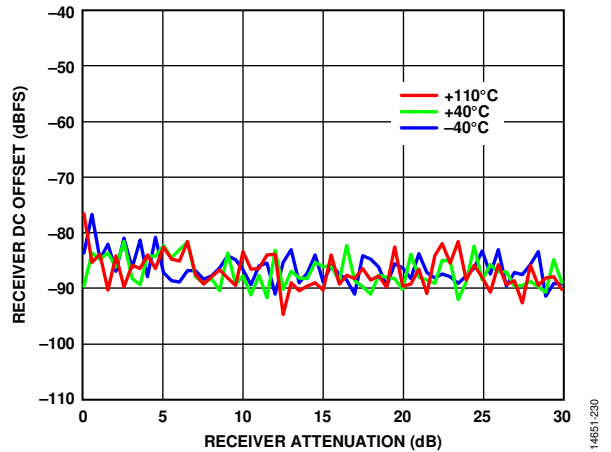

Figure 191. Receiver DC Offset vs. Receiver Attenuation, 5850 MHz LO, 100 MHz RF Bandwidth, 122.88 MSPS Sample Rate

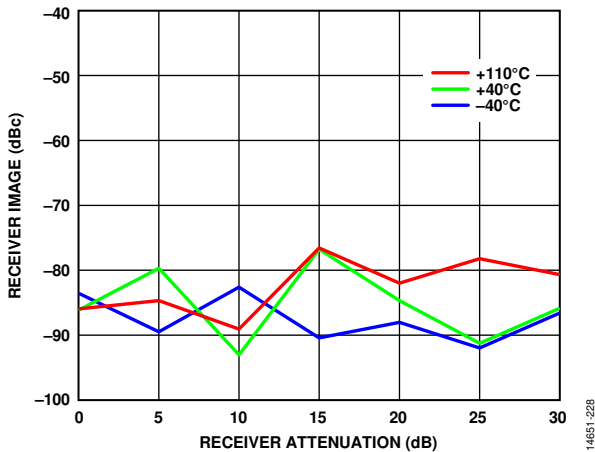

Figure 189. Receiver Image vs. Receiver Attenuation, 5600 MHz LO, Continuous Wave (CW) Signal 10 MHz Offset, 100 MHz RF Bandwidth, Background Tracking Calibration (BTC) Active, 122.88 MSPS Sample Rate

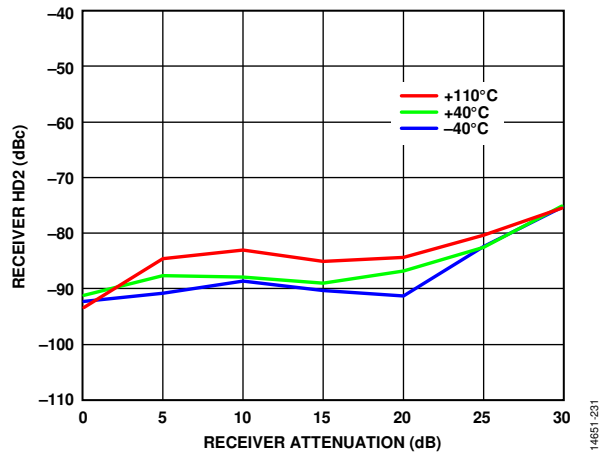

Figure 192. Receiver HD2 vs. Receiver Attenuation, 5600 MHz LO, CW Signal 10 MHz Offset, -20 dBm at 0 dB Attenuation, Input Power Increasing Decibel for Decibel with Attenuation, 100 MHz RF Bandwidth, 122.88 MSPS Sample Rate

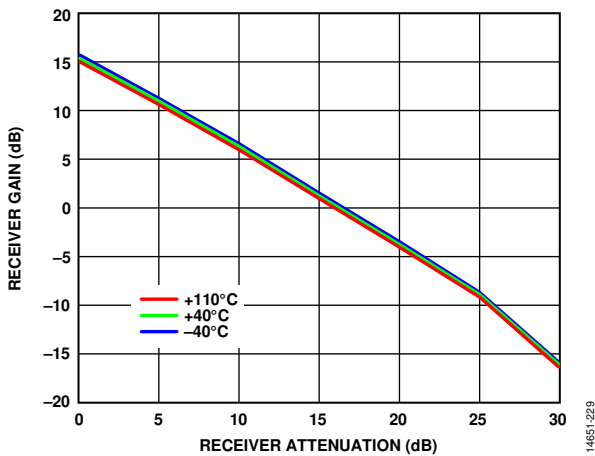

Figure 190. Receiver Gain vs. Receiver Attenuation, 5600 MHz LO, CW Signal 10 MHz Offset, 100 MHz RF Bandwidth, 122.88 MSPS Sample Rate

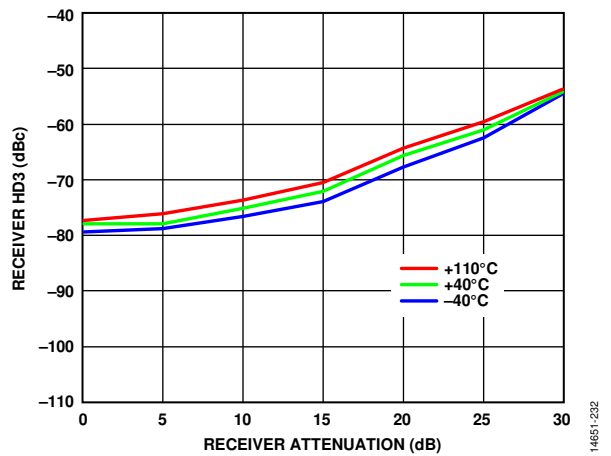

Figure 193. Receiver HD3 vs. Receiver Attenuation, 5600 MHz LO, CW Signal 10 MHz Offset, -20 dBm at 0 dB Attenuation, Input Power Increasing Decibel for Decibel with Attenuation, 100 MHz RF Bandwidth, 122.88 MSPS Sample Rate

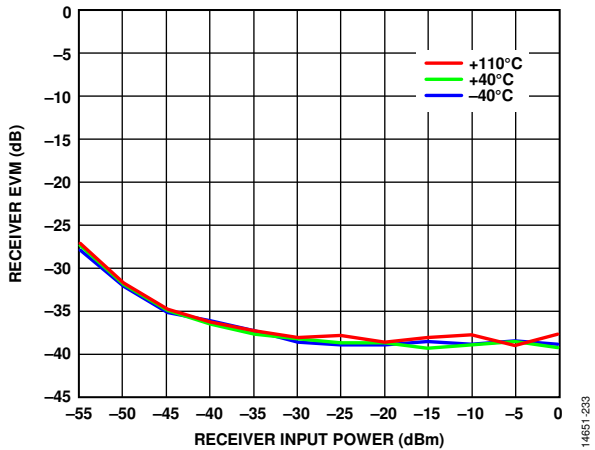

Figure 194. Receiver Error Vector Magnitude (EVM) vs. Receiver Input Power, 5600 MHz LO, 100 MHz RF Bandwidth LTE, 20 MHz Uplink Centered at DC, BTC Active, 122.88 MSPS Sample Rate

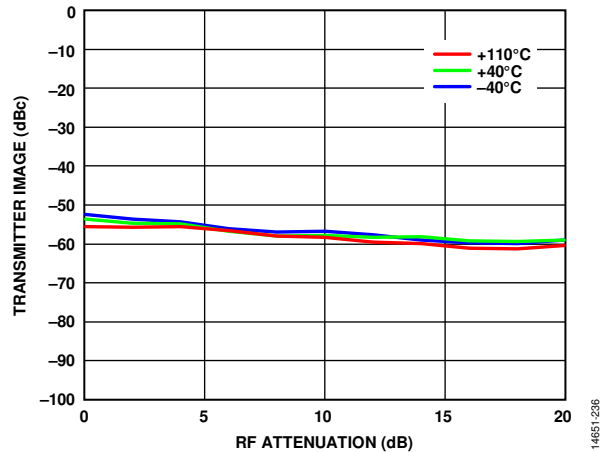

Figure 197. Transmitter Image vs. RF Attenuation, 75 MHz RF Bandwidth, 5600 MHz LO, 0 dB RF Attenuation, Transmitter Quadrature Error Correction (QEC) Tracking Run with Two 20 MHz LTE Downlink Carriers, Then Image Measured with CW 10 MHz Offset from LO, 3 dB Digital Backoff, 245.76 MSPS Sample Rate

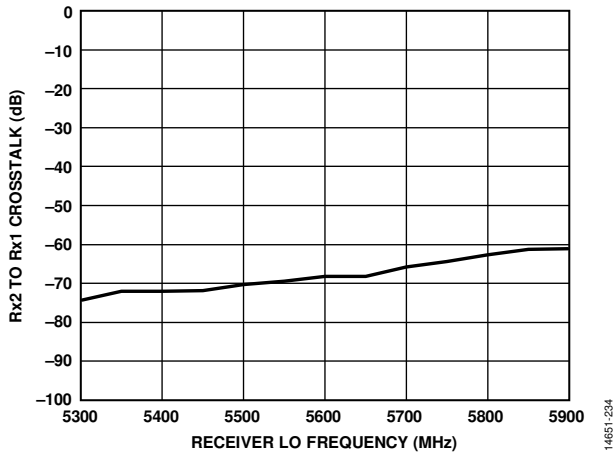

Figure 195. Rx2 to Rx1 Crosstalk vs. Receiver LO Frequency, 100 MHz RF Bandwidth, CW Tone 3 MHz Offset from LO

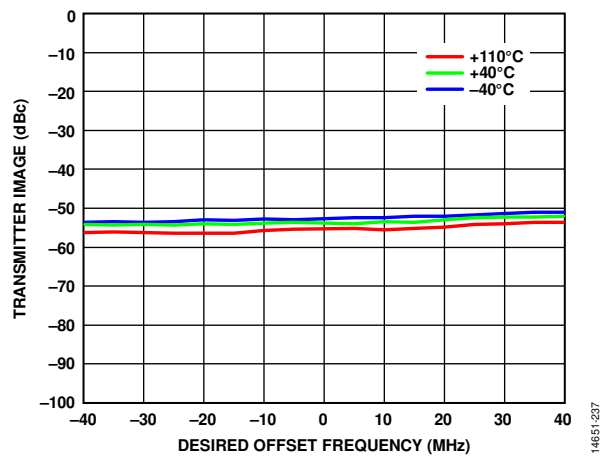

Figure 198. Transmitter Image vs. Desired Offset Frequency, 75 MHz RF Bandwidth, 5600 MHz LO, 0 dB RF Attenuation, Transmitter QEC Tracking Run with Two 20 MHz LTE Downlink Carriers, Then Image Measured with CW Signal, 3 dB Digital Backoff, 245.76 MSPS Sample Rate

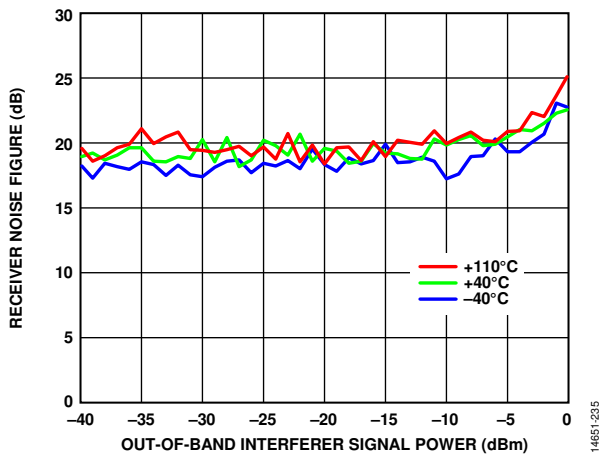

Figure 196. Receiver Noise Figure vs. Out-of-Band Interferer Signal Power, 5400 MHz LO, 5600 MHz CW Interferer, NF Integrated over 7 MHz to 10 MHz

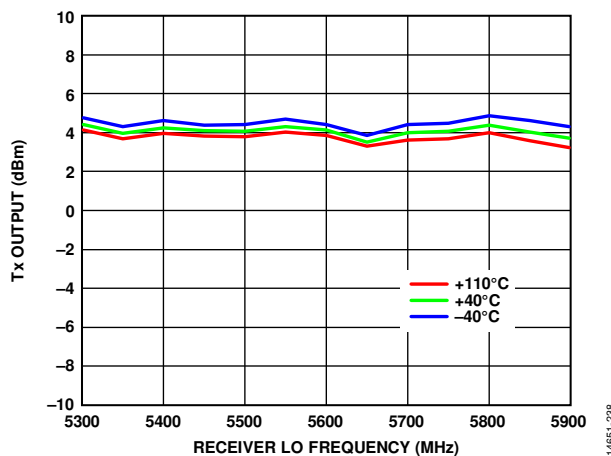

Figure 199. Tx Output Power, Transmitter QEC, and External LO Leakage Active, 5 MHz CW Offset Signal, 1 MHz Resolution Bandwidth, 245.76 MSPS Sample Rate

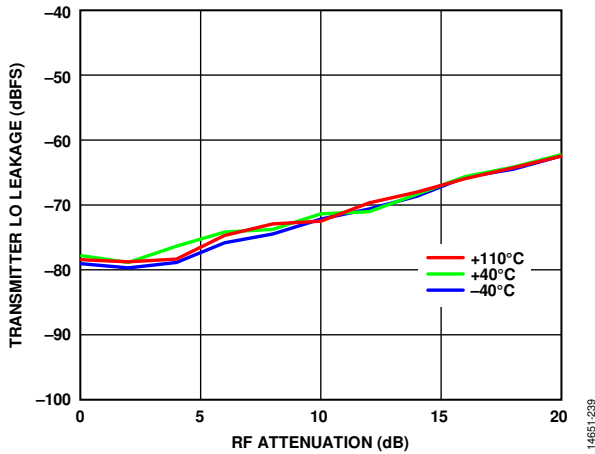

Figure 200. Transmitter LO Leakage vs. RF Attenuation, 5600 MHz LO, External Transmitter QEC, and LO Leakage Tracking Active, CW Signal 10 MHz Offset from LO, 6 dB Digital Backoff, 1 MHz Measurement Bandwidth

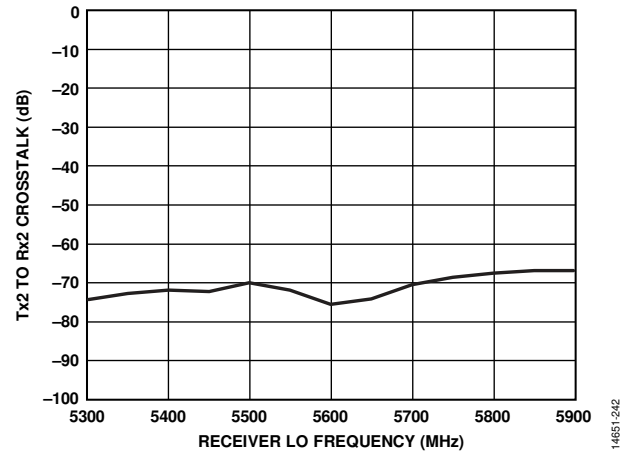

Figure 203. Tx2 to Rx2 Crosstalk vs. Receiver LO Frequency, 100 MHz Receiver RF Bandwidth, 75 MHz Transmitter RF Bandwidth, CW Signal 3 MHz Offset from LO

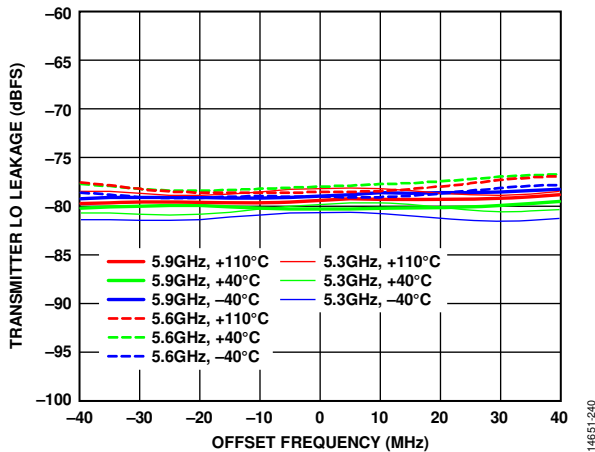

Figure 201. Transmitter LO Leakage vs. Offset Frequency, External Transmitter QEC and LO Leakage Tracking Active, 6 dB Digital Backoff, 1 MHz Measurement Bandwidth

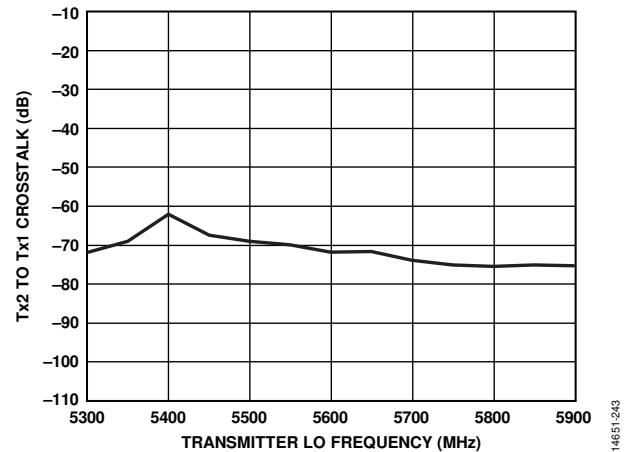

Figure 204. Tx2 to Tx1 Crosstalk vs. Transmitter LO Frequency, 75 MHz RF Bandwidth, CW Signal 3 MHz Offset from LO

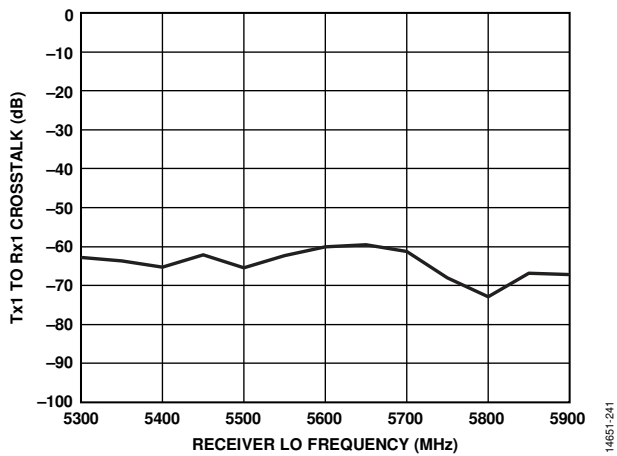

Figure 202. Tx1 to Rx1 Crosstalk vs. Receiver LO Frequency, 100 MHz Receiver RF Bandwidth, 75 MHz Transmitter RF Bandwidth, CW Signal 3 MHz Offset from LO

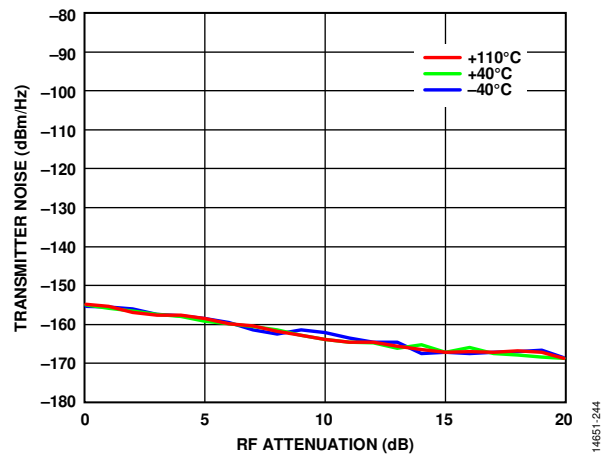

Figure 205. Transmitter Noise vs. RF Attenuation, 5600 MHz LO, 1 MHz Offset Frequency

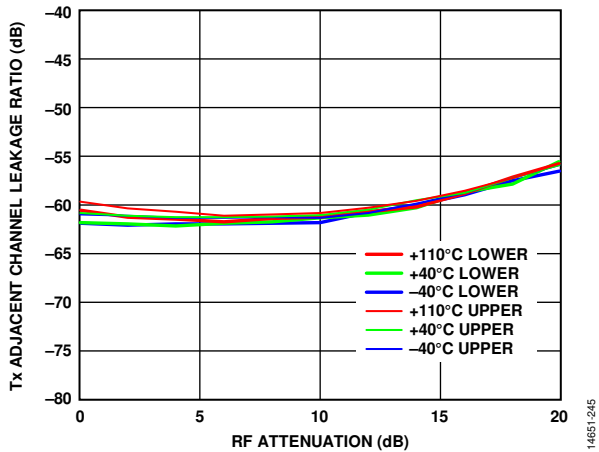

Figure 206. Tx Adjacent Channel Leakage Ratio vs. RF Attenuation, 5600 MHz LO, 75 MHz RF Bandwidth, Four-Carrier W-CDMA Desired Signal, Transmitter QEC and LO Leakage Tracking Active

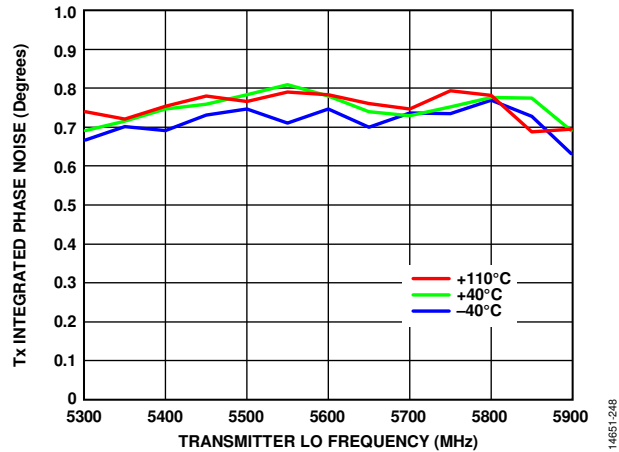

Figure 209. Tx Integrated Phase Noise vs. Transmitter LO Frequency, 75 MHz RF Bandwidth, CW 10 MHz Offset from LO, 3 dB Digital Backoff

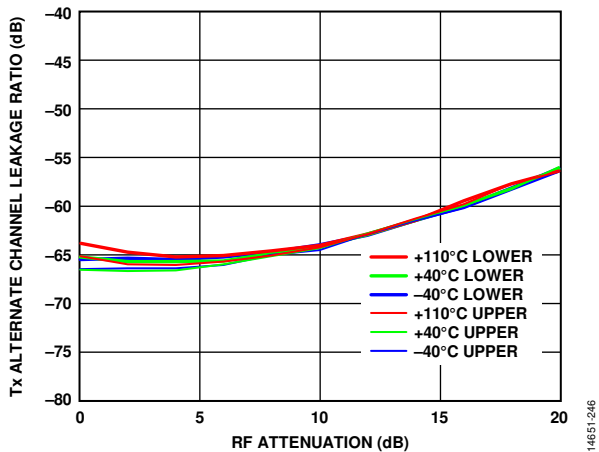

Figure 207. Tx Alternate Channel Leakage Ratio vs. RF Attenuation, 5600 MHz LO, 75 MHz RF Bandwidth, Four-Carrier W-CDMA Desired Signal, 2 dB Digital Backoff, Transmitter QEC and LO Leakage Tracking Active

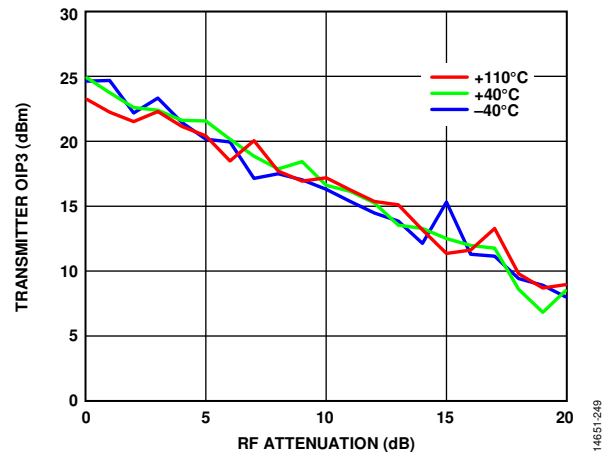

Figure 210. Transmitter OIP3 vs. RF Attenuation, 5600 MHz LO, 75 MHz RF Bandwidth, $f_1 = 20$ MHz, $f_2 = 21$ MHz, 3 dB Digital Backoff, 245.76 MSPS Sample Rate

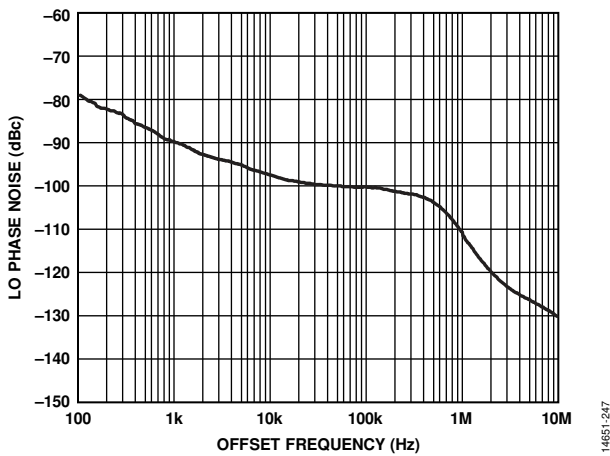

Figure 208. LO Phase Noise vs. Offset Frequency, 3 dB Digital Backoff, 5850 MHz LO

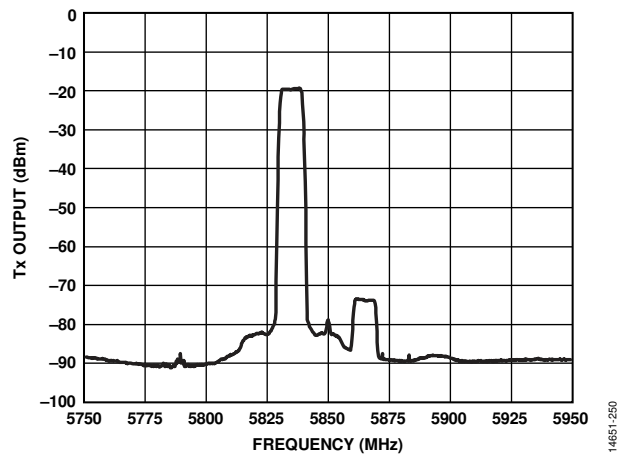

Figure 211. Tx Output Power Spectrum, 3 dB Digital and 1 dB RF Backoff, 40 MHz RF Bandwidth, Transmitter QEC, and Internal LO Leakage Active, LTE 10 MHz Signal, 5850 MHz LO, 1 MHz Resolution Bandwidth, 122.88 MSPS Sample Rate, Test Equipment Noise Floor De-Embedded

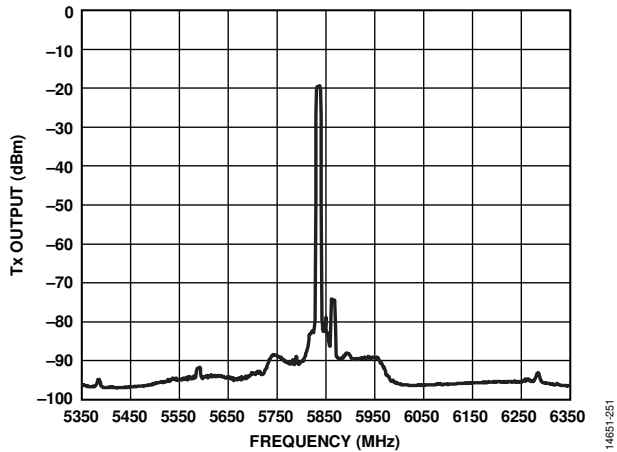

Figure 212. Tx Output Power Spectrum, 3 dB Digital and 1 dB RF Backoff, 40 MHz RF Bandwidth, Transmitter QEC, and Internal LO Leakage Active, LTE 10 MHz Signal, 5850 MHz LO, 1 MHz Resolution Bandwidth, 122.88 MSPS Sample Rate, Test Equipment Noise Floor De-Embedded

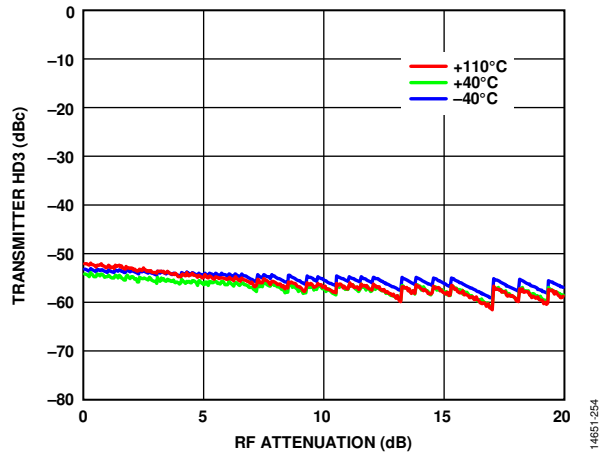

Figure 215. Transmitter HD3 vs. RF Attenuation, 5850 MHz LO, 5855 MHz CW Desired Signal, 75 MHz RF Bandwidth, 245.76 MSPS Sample Rate

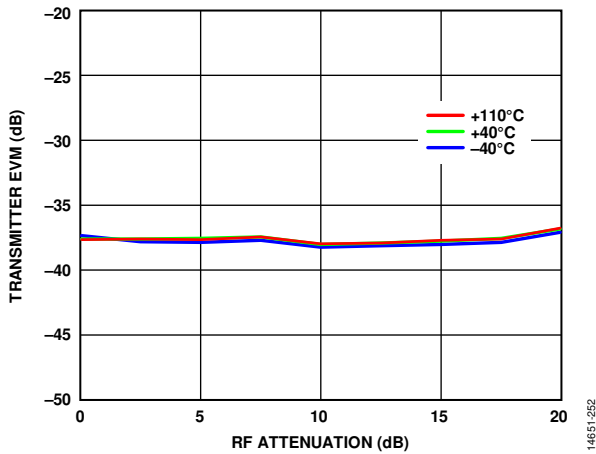

Figure 213. Transmitter EVM vs. RF Attenuation, 5600 MHz LO, Transmitter LO Leakage, and Transmitter QEC Tracking Active, 75 MHz RF Bandwidth, LTE 20 MHz Downlink Signal, 245.76 MSPS Sample Rate

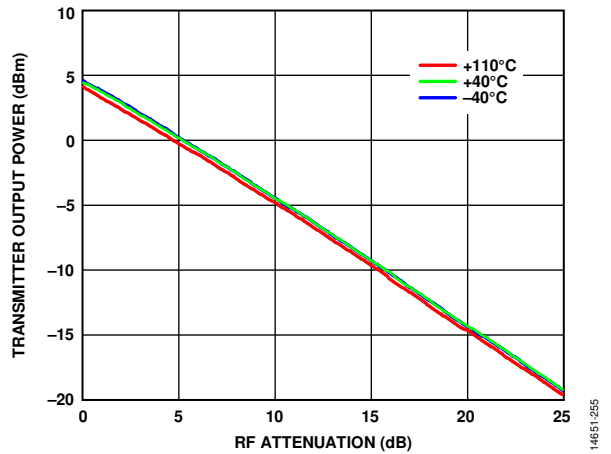

Figure 216. Transmitter Output Power vs. RF Attenuation, 5850 MHz LO, 5855 MHz CW Desired Signal, 75 MHz RF Bandwidth, 245.76 MSPS Sample Rate

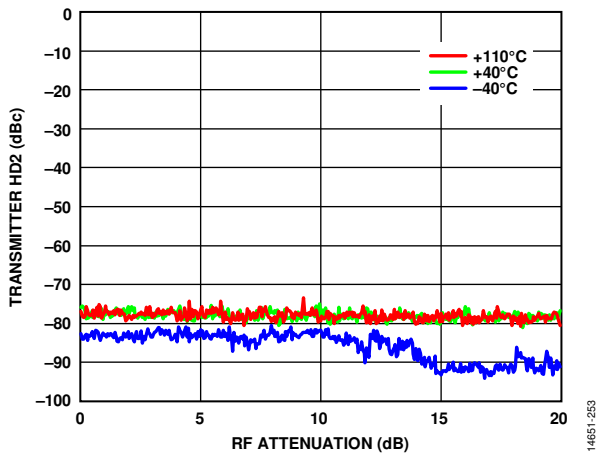

Figure 214. Transmitter HD2 vs. RF Attenuation, 5850 MHz LO, 5855 MHz CW Desired Signal, 75 MHz RF Bandwidth, 245.76 MSPS Sample Rate

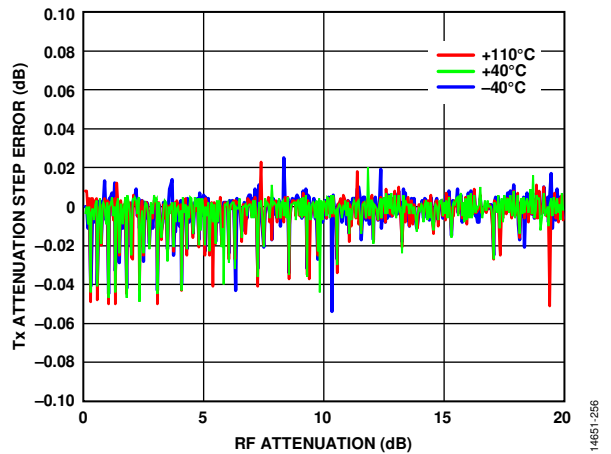

Figure 217. Tx Attenuation Step Error vs. RF Attenuation, 5850 MHz LO, 5855 MHz CW Desired Signal, 75 MHz RF Bandwidth, 245.76 MSPS Sample Rate

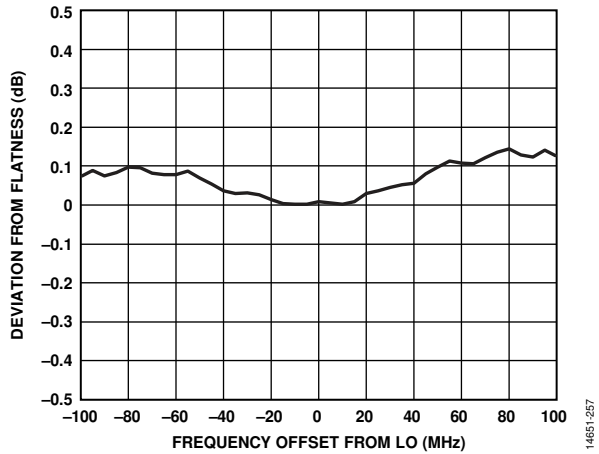

Figure 218. Transmitter Frequency Response Deviation from Flatness vs. Frequency Offset from LO, 5850 MHz LO, 200 MHz Synthesis Bandwidth, 6 dB Digital Backoff, 245.76 MSPS Sample Rate

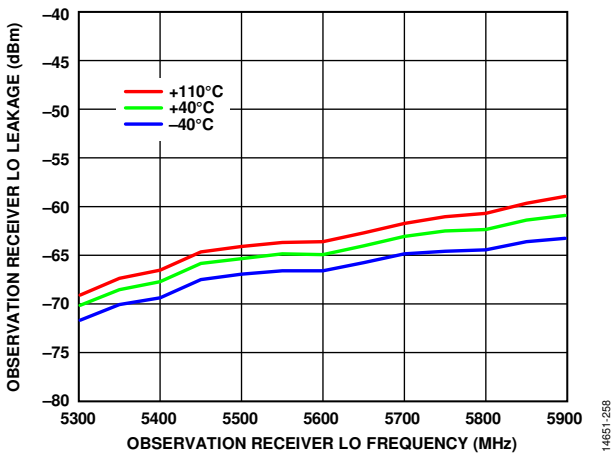

Figure 219. Observation Receiver LO Leakage vs. Observation Receiver LO Frequency, 0 dB Receiver Attenuation, 200 MHz RF Bandwidth, 245.76 MSPS Sample Rate

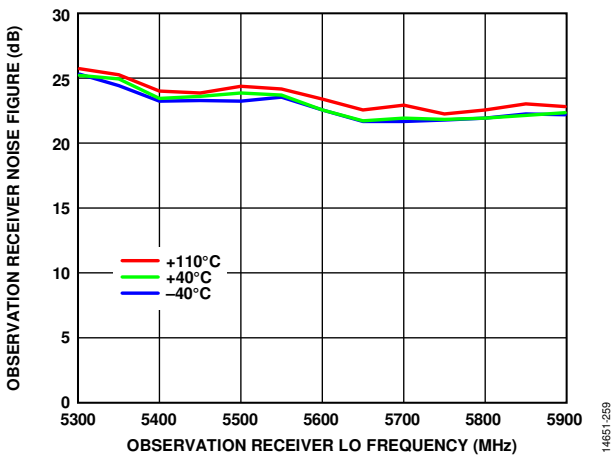

Figure 220. Observation Receiver Noise Figure vs. Observation Receiver LO Frequency, 0 dB Receiver Attenuation, 200 MHz RF Bandwidth, 245.76 MSPS Sample Rate, 100 MHz Integration Bandwidth

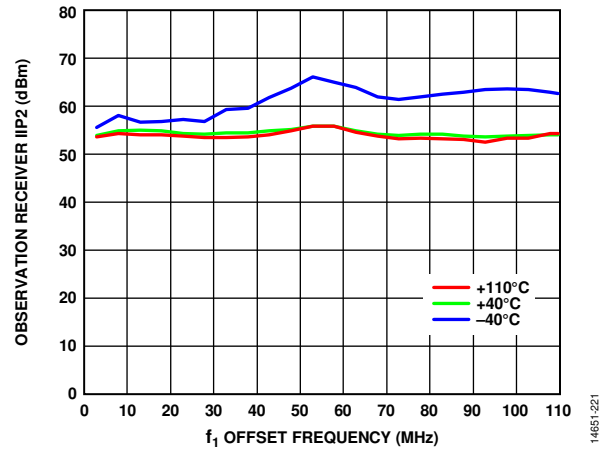

Figure 221. Observation Receiver IIP2 vs. f_1 Offset Frequency, 5600 MHz LO, 0 dB Attenuation, 200 MHz RF Bandwidth, $f_2 = f_1 + 1$ MHz, 245.76 MSPS Sample Rate

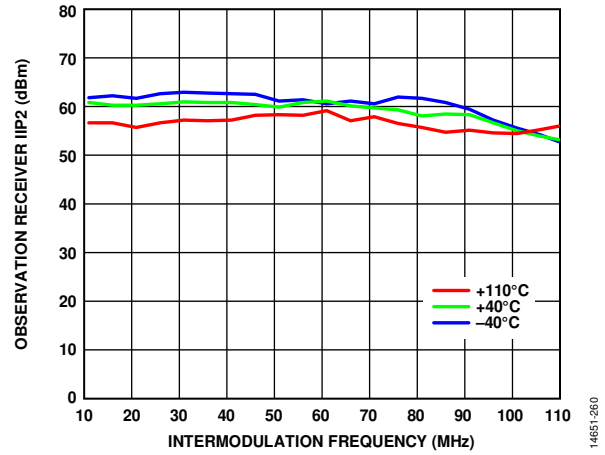

Figure 222. Observation Receiver IIP2 vs. Intermodulation Frequency ($f_2 - f_1$), 5600 MHz LO, 0 dB Attenuation, 200 MHz RF Bandwidth, 245.76 MSPS Sample Rate

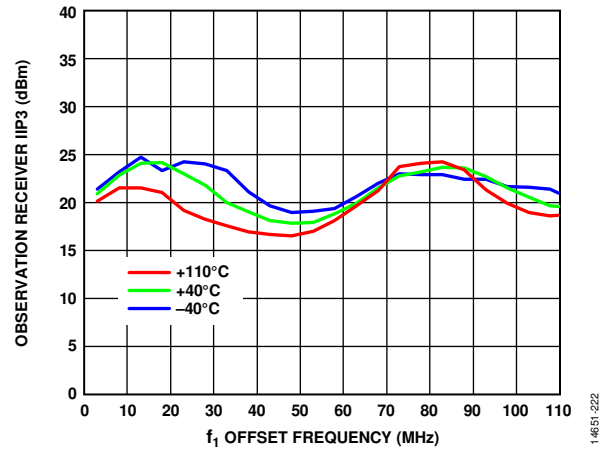

Figure 223. Observation Receiver IIP3 vs. f_1 Offset Frequency, 5600 MHz LO, 0 dB Attenuation, 200 MHz RF Bandwidth, $f_2 = 2 f_1 + 1$ MHz, 245.76 MSPS Sample Rate

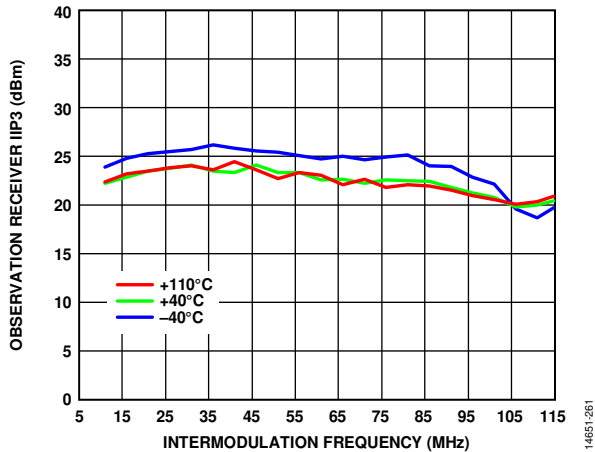

Figure 224. Observation Receiver IIP3 vs. Intermodulation Frequency ($f_2 - 2f_1$), 5600 MHz LO, 0 dB Attenuation, 200 MHz RF Bandwidth, 245.76 MSPS Sample Rate

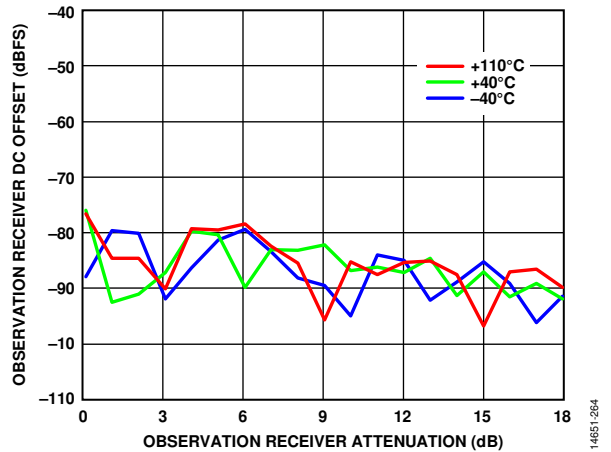

Figure 227. Observation Receiver DC Offset vs. Observation Receiver Attenuation, 5850 MHz LO, CW Signal 30 MHz Offset, -15 dBm Input, 200 MHz RF Bandwidth, 245.76 MSPS Sample Rate

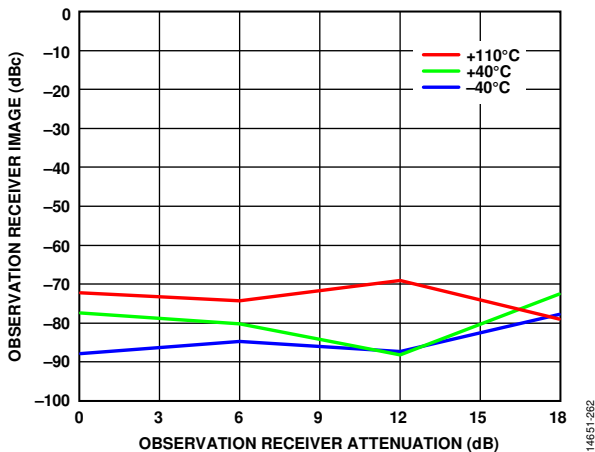

Figure 225. Observation Receiver Image vs. Observation Receiver Attenuation, 5600 MHz LO, CW Signal 30 MHz Offset, 200 MHz RF Bandwidth, BTC Active, 245.76 MSPS Sample Rate

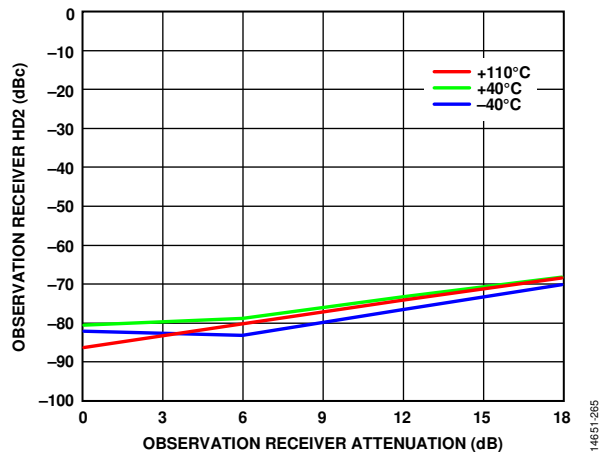

Figure 228. Observation Receiver HD2 vs. Observation Receiver Attenuation, 5600 MHz LO, CW Signal 30 MHz Offset, -15 dBm Input, Input Power Increasing Decibel for Decibel with Attenuation, 200 MHz RF Bandwidth, 245.76 MSPS Sample Rate

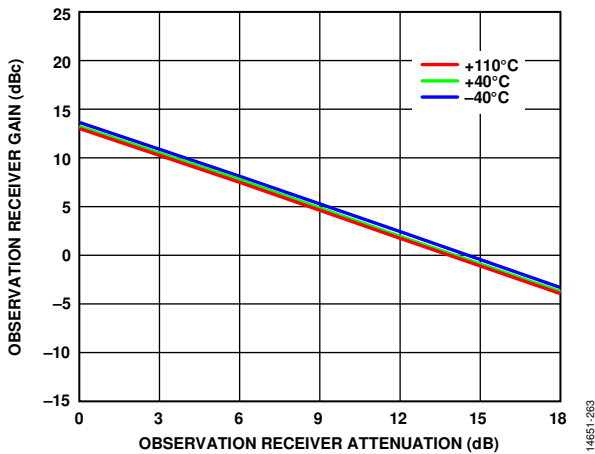

Figure 226. Observation Receiver Gain vs. Observation Receiver Attenuation, 5600 MHz LO, CW Signal 30 MHz Offset, 200 MHz RF Bandwidth, 245.76 MSPS Sample Rate

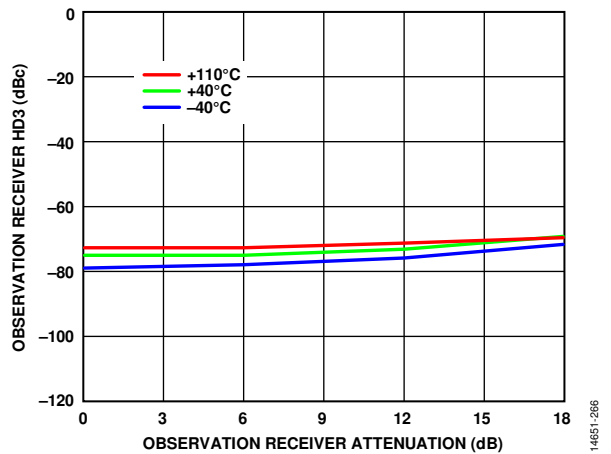

Figure 229. Observation Receiver HD3 vs. Observation Receiver Attenuation, 5600 MHz LO, CW Signal 30 MHz Offset, -15 dBm Input, Input Power Increasing Decibel for Decibel with Attenuation, 200 MHz RF Bandwidth, 245.76 MSPS Sample Rate

THEORY OF OPERATION

The AD9371 is a highly integrated RF transceiver that can be configured for a wide range of applications. The device integrates all the RF, mixed-signal, and digital blocks necessary to provide transmit and receive functions in a single device. Programmability allows the two receiver channels and two transmitter channels to be used in TDD and FDD systems for 3G and 4G cellular standards.

The observation receiver channel has two inputs for use in monitoring the transmitter outputs. This channel has a wide channel bandwidth that receives the entire transmit band and feeds it back to the digital section for error correction purposes. In addition, three sniffer receiver inputs can monitor different radio frequency bands (one at a time). These channels share the baseband ADC and digital processing with the two ORx inputs.

The AD9371 contains four high speed serial interface links for the transmit chain and four high speed serial interface links shared by the Rx, ORx, and SnRx channels (JESD204B, Subclass 1 compliant), providing a low pin count and reliable data interface to a field-programmable gate array (FPGA) or other custom integrated baseband solutions.

The AD9371 also provides self calibration for dc offset, LO leakage, and quadrature error correction using an integrated microcontroller core to maintain a high performance level under varying temperatures and input signal conditions. Firmware is supplied with the device to schedule all calibrations with no user interaction. The device includes test modes that allows system designers to debug designs during prototyping and optimize radio configurations.

TRANSMITTER (Tx)

The AD9371 employs a direct conversion transmitter architecture consisting of two identical and independently controlled channels that provide all the digital processing, mixed signal, and RF blocks necessary to implement a direct conversion system. Both channels share a common frequency synthesizer.

The digital data from the JESD204B lanes pass through a fully programmable 96-tap FIR filter with optional interpolation. The FIR output is sent to a series of conversion filters that provide additional filtering and data rate interpolation prior to reaching the DAC. Each DAC has an adjustable sample rate and is linear up to full scale.

When converted to baseband analog signals, the in-phase (I) and quadrature (Q) signals are filtered to remove sampling artifacts, and then the signals are fed to the upconversion mixers. At the mixer stage, the I and Q signals are recombined and modulated onto the carrier frequency for transmission to the output stage. Each transmit chain provides a wide attenuation adjustment range with fine granularity to help designers optimize SNR.

RECEIVER (Rx)

The AD9371 contains dual receiver channels. Each Rx channel is a direct conversion system that contains a programmable attenuator stage, followed by matched I and Q mixers that downconvert received signals to baseband for digitization.

To achieve gain control, a programmed gain index map is implemented. This gain map distributes attenuation among the various Rx blocks for optimal performance at each power level. In addition, support is available for both automatic and manual gain control modes.

The receiver includes Σ - Δ ADCs and adjustable sample rates that produce data streams from the received signals. The signals can be conditioned further by a series of decimation filters and a fully programmable 72-tap FIR filter with additional decimation settings. The sample rate of each digital filter block is adjustable by changing the decimation factors to produce the desired output data rate.

OBSERVATION RECEIVER (ORx)

The ORx operates in a similar manner to the main receivers. Each input is differential and uses a dedicated mixer. The ORx inputs share a baseband ADC and baseband section; therefore, only one can be active at any time. The mixed-signal and digital section is identical in design and operation to the main receiver channels. This channel can monitor the Tx channels and implement error correction functions. It can also be used as a general-purpose receiver.

SNIFFER RECEIVER (SnRx)

The sniffer receiver provides three differential inputs that can monitor different frequency bands. Each input has a low noise amplifier (LNA) that is multiplexed to feed a single mixer. The output of this mixer stage is multiplexed with the ORx receiver mixers to feed the same baseband section. The SnRx bandwidth is limited to 20 MHz. This receiver can also be used as a general-purpose receiver if the bandwidth and RF performance are acceptable for a given application. The sniffer channel has limited operation from 400 MHz to 4000 MHz. Performance cannot be guaranteed for LO settings above 4000 MHz.

These receiver inputs also provide an LNA bypass mode that removes the gain of the LNA when large signals are present. Note that no requirements for the LNA bypass mode are included in Table 1; performance specifications are only relative to the scenario in which the LNA is enabled.

CLOCK INPUT

The AD9371 requires a differential clock connected to the DEV_CLK_IN+/DEV_CLK_IN- pins. The frequency of the clock input must be between 10 MHz and 320 MHz, and it must have very low phase noise because this signal generates the RF local oscillator and internal sampling clocks.

SYNTHESIZERS

RF PLL

The [AD9371](#) contains three fractional-N PLLs to generate the RF LOs used by the transmitter, receiver, and observation receiver. The PLL incorporates an internal VCO and loop filter that require no external components. The internal VCO LDO regulators eliminate the need for additional external power supplies for the PLLs. These regulators only require an external bypass capacitor for each supply.

Clock PLL

The [AD9371](#) contains a PLL synthesizer that generates all of the baseband related clock signals and SERDES clocks. This PLL is programmed based on the data rate and sample rate requirements of the system.

External LO Inputs

The [AD9371](#) provides two external LO inputs to allow an external synthesizer to be used with the device. These inputs must be 2× the desired LO frequency. Note that operation for the external LO option is limited to a maximum of 4000 MHz. One input pair is dedicated to the receiver LO generation circuit and the other input provides the input to the transmitter and observation receiver LO generation blocks. Note that the observation receiver can obtain the LO from either the Tx LO generator block or its own dedicated PLL. When the sniffer channel is enabled, the LO for this block can only come from the dedicated internal observation channel PLL.

SERIAL PERIPHERAL INTERFACE (SPI) INTERFACE

The [AD9371](#) uses a SPI to communicate with the baseband processor (BBP). This interface can be configured as a 4-wire interface with dedicated receive and transmit ports, or it can be configured as a 3-wire interface with a bidirectional data communications port. This bus allows the BBP to set all device control parameters using a simple address data serial bus protocol.

Write commands follow a 24-bit format. The first bit sets the bus direction of the bus transfer. The next 15 bits set the address where data is written. The final eight bits are the data being transferred to the specific register address.

Read commands follow a similar format with the exception that the first 16 bits are transferred on the SDIO pin, and the final eight bits are read from the [AD9371](#), either on the SDO pin in 4-wire mode or on the SDIO pin in 3-wire mode.

GPIO_x AND GPIO_3P3_x PINS

The [AD9371](#) general-purpose input/output signals referenced to the VDD_IF supply can be configured for numerous functions. Some of these pins, when configured as outputs, are used by the BBP as real-time signals to provide a number of internal settings and measurements. This configuration allows the BBP to monitor receiver performance in different situations. A pointer register selects what information is output to these pins. Signals used for

manual gain mode, calibration flags, state machine states, and various receiver parameters are among the outputs that can be monitored on these pins. In addition, certain pins can be configured as inputs and used in various functions such as setting the receiver gain in real time.

The GPIO_3P3_x pins referenced to the VDDA_3P3 supply are also included in the device and can provide control signals to the external components such as VGAs or attenuators in the RF section that typically use a higher reference voltage.

AUXILIARY CONVERTERS

Auxiliary ADC Inputs (AUXADC_x)

The [AD9371](#) contains an auxiliary ADC that is multiplexed to four input pins (AUXADC_0 through AUXADC_3). This block can monitor system voltages without adding additional components. The auxiliary ADC is 12 bits with an input voltage range of 0.05 V to VDDA_3P3 – 0.25 V. When enabled, the auxiliary ADC is free running. Software reads of the output value provide the last value latched at the ADC output.

Auxiliary DACs (AUXDAC_x)

The [AD9371](#) contains 10 identical auxiliary DACs (AUXDAC_0 to AUXDAC_9) that can supply bias voltages, analog control voltages, or other system functionality. The inputs of these auxiliary DACs (AUXDAC_0 to AUXDAC_9) are multiplexed with the GPIO_3P3_x pins according to Table 7. The auxiliary DACs are 10 bits and have an output voltage range of approximately 0.5 V to VDDA_3P3 – 0.3 V and have a current drive of 10 mA.

Table 7. AUXDAC Input Pin Assignments

GPIO_3P3 Pin	AUXDAC Output
GPIO_3P3_9	AUXDAC_0
GPIO_3P3_7	AUXDAC_1
GPIO_3P3_6	AUXDAC_2
GPIO_3P3_10	AUXDAC_3
GPIO_3P3_0	AUXDAC_4
GPIO_3P3_1	AUXDAC_5
GPIO_3P3_3	AUXDAC_6
GPIO_3P3_4	AUXDAC_7
GPIO_3P3_5	AUXDAC_8
GPIO_3P3_8	AUXDAC_9

JESD204B DATA INTERFACE

The digital data interface for the [AD9371](#) uses JEDEC Standard JESD204B Subclass 1. The serial interface operates at speeds of up to 6144 Mbps. The benefits of the JESD204B interface include a reduction in required board area for data interface routing and smaller package options due to the need for fewer pins. Digital filtering is included in all receiver and transmitter paths to provide proper signal conditioning and sampling rates to meet the JESD204B data requirements. Examples of the digital filtering configurations for the Tx and Rx paths are shown in Figure 230 and Figure 231, respectively.

Table 8. Example Rx/Tx Interface Rates (Two Rx/Two Tx Channels, Maximum JESD Lane Rates)

Tx/Tx Synthesis/ Rx Bandwidth (MHz)	Tx Input Rate (MSPS)	Rx Output Rate (MSPS)	JESD204B Lane Rate (Mbps), Two Tx/Two Rx	JESD204B (No. of Lanes) Tx/Rx	Reference Clock Options (MHz)
100/250/100	307.2	153.6	6144	4/2	122.88, 153.6, 245.76, 307.2
75/200/100	245.76	122.88	4915.2	4/2	122.88, 245.76
20/100/40	122.88	61.44	2457.6	4/2	122.88, 245.76
20/100/20	122.88	30.72	2457.6	4/1	122.88, 245.76

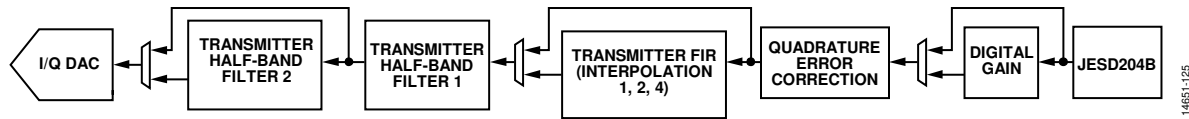

Figure 230. Example Tx Data Path Filter Implementation

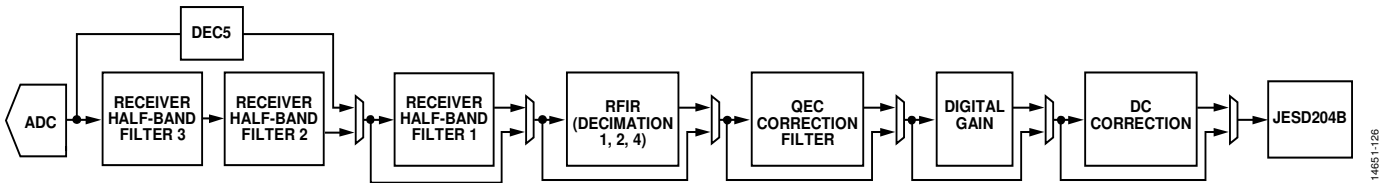

Figure 231. Data Rx Data Path Filter Implementation

POWER SUPPLY SEQUENCE

The AD9371 requires a specific power-up sequence to avoid undesired power-up currents. The optimal power-on sequence starts the process by powering up the VDIG and the VDDA_1P3 (analog) supplies simultaneously. If they cannot power up simultaneously, the VDIG supply must power up first. The VDDA_3P3, VDDA_1P8, and JESD_VTT_DES supplies must then power up after the VDIG and VDDA_1P3 supplies. Note that the VDD_IF supply can power up at any time. It is also recommended to toggle the RESET signal after power has stabilized prior to configuration. Follow the reverse order of the power-up sequence to power-down.

Note that VDDA_1P3 refers to all analog 1.3 V supplies including the following: VDDA_BB, VDDA_CLKSYNTH, VDDA_TXLO, VDDA_RXRF, VDDA_RXSYNTH, VDDA_RXVCO, VDDA_RXTX, VDDA_TXSYNTH, VDDA_TXVCO, VDDA_CALPLL, VDDA_SNRXSYNTH, VDDA_SNRXVCO, VDDA_CLK, and VDDA_RXLO.

JTAG BOUNDARY SCAN

The AD9371 provides support for a JTAG boundary scan. There are five dual-function pins associated with the JTAG interface. These pins, listed in Table 9, are used to access the on-chip test access port. To enable the JTAG functionality, set the GPIO_0 through GPIO_3 pins according to Table 10 depending on how the desired JESD204B sync pin (that is, SYNCINB0+, SYNCINB0-, SYNCINB1+, SYNCINB1-, SYNCBOUTB0+, or SYNCBOUTB0-) is configured in the software (LVDS or CMOS mode). Pull the TEST pin high to enable the JTAG mode.

Table 9. Dual-Function Boundary Scan Test Pins

Mnemonic	JTAG Mnemonic	Description
GPIO_4	TRST	Test access port reset
GPIO_5	TDO	Test data output
GPIO_6	TDI	Test data input
GPIO_7	TMS	Test access port mode select
GPIO_18	TCK	Test clock

Table 10. JTAG Modes

Test Pin Level	GPIO_0 to GPIO_3	Description
0	XXXX ¹	Normal operation
1	1001	JTAG mode with LVDS JESD204B sync signals
1	1011	JTAG mode with CMOS JESD204B sync signals

¹ X means don't care.

OUTLINE DIMENSIONS

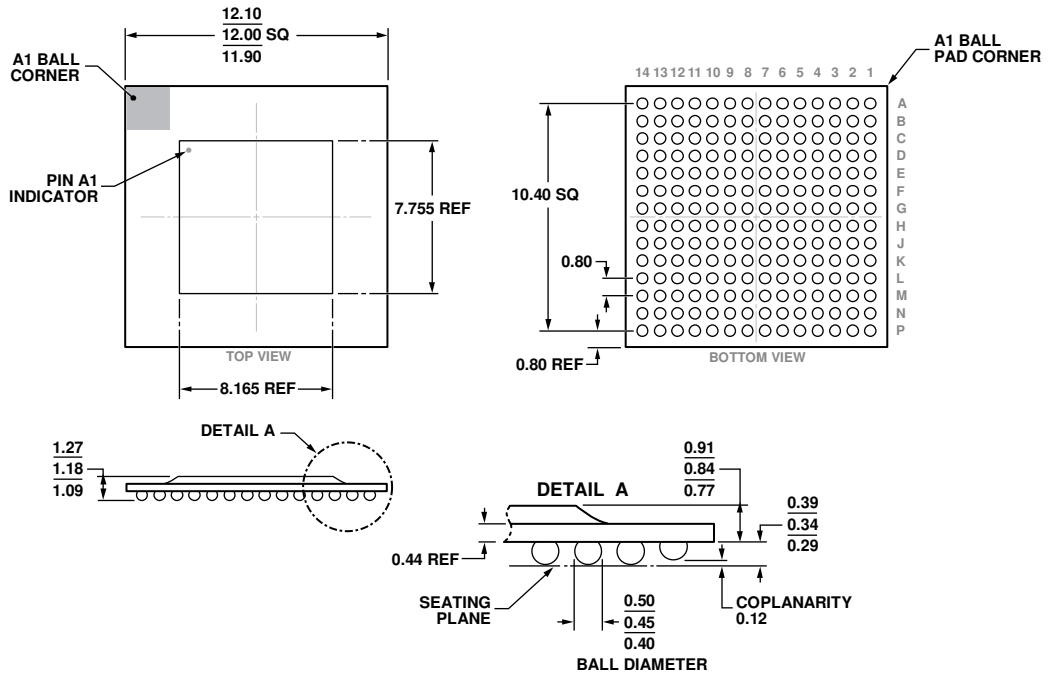

COMPLIANT TO JEDEC STANDARDS MO-275-GGAB-1.

Figure 232. 196-Ball Chip Scale Package Ball Grid Array [CSP_BGA] (BC-196-12)
Dimensions shown in millimeters

ORDERING GUIDE

Model ¹	Temperature Range	Package Description	Package Option
AD9371BBCZ	-40°C to +85°C	196-Ball Chip Scale Package Ball Grid Array [CSP_BGA]	BC-196-12
AD9371BBCZ-REEL	-40°C to +85°C	196-Ball Chip Scale Package Ball Grid Array [CSP_BGA]	BC-196-12
ADRV9371-N/PCBZ		Evaluation Board, 2600 MHz Matching Circuits	
ADRV9371-W/PCBZ		Evaluation Board, 300 MHz to 6000 MHz Matching Circuits	

¹ Z = RoHS Compliant Part.