

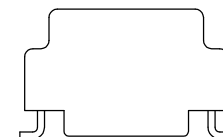

NOTES:

1. ROHS COMPLIANT
2. STORAGE TEMPERATURE: -50°C TO +125°C
3. COMPLIANCE TO J-STD:
 - A. J-STD-002: SOLDERABILITY AT 245°C REFLOW PROFILE
 - B. J-STD-020: LEVEL 1, NO MOISTURE SENSITIVE
 - C. J-STD-075: R7, 245°C MAXIMUM THROUGH REFLOW SOLDER
4. TO ORDER TAPE & REEL PACKAGING ADD A "T" SUFFIX TO THE PART NUMBER(i.e HXXXXXXNL BECOMES HXXXXXXNLT).

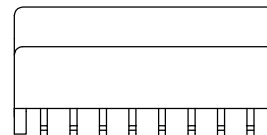
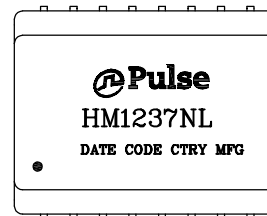

FINAL OUTLINE

© Copyright, 2017. Pulse Electronics Corp. All rights reserved. Pulse confidential & proprietary. (10/18/17)

PRODUCT DESCRIPTION	TLA DRAWING	PS DRAWING	SHEET	PART NO.	DATASHEET REV.
TRANSFORMER/CMC,3.2kVDC ISO,SGL,SM	HM1237NL-10	PS-2755.002-A	1 OF 3	HM1237NL	F

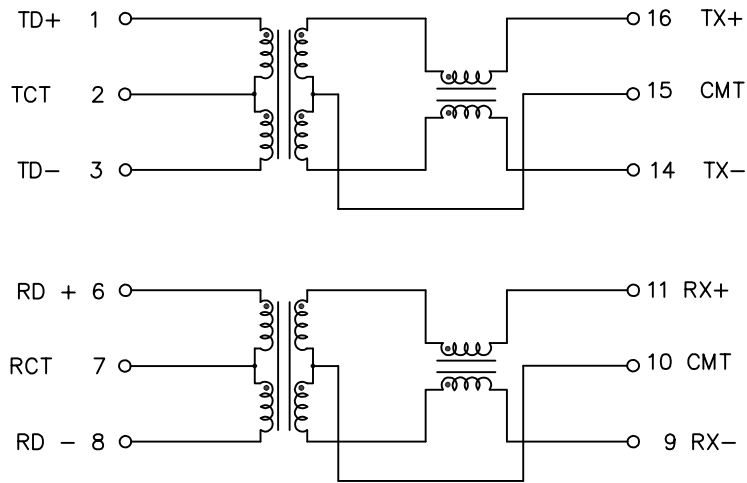

SCHEMATIC

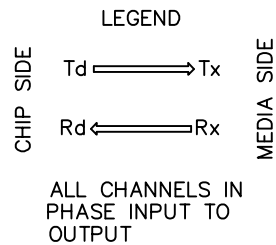

ELECTRICAL CHARACTERISTICS AT +25°C UNLESS OTHER SPECIFIED
MEETS IEEE 802.3 SPECIFICATION

PARAMETER	SPECIFICATIONS	
QUALIFICATION	AEC-Q200 (PENDING)	
PARAMETER	SPECIFICATIONS	
OPERATING TEMP	-40°C TO +125°C	
TURNS RATIO	1 : 1 ±2%	
POLARITY	PER SCHEMATIC	
INDUCTANCE (OCL) 100 KHZ, 100 mVRMS	650 uH MIN (@25°C) 500 uH MIN (@-40°C~+125°C)	
INSERTION LOSS	1-80 MHz	125 MHz
	-1.0 dB MAX	-3.0 dB MAX
RETURN LOSS Z _{OUT} = 100 OHMS	5 MHz	30-80 MHz
	-25 dB MIN	-16 + 20LOG ₁₀ (f/30 MHz) dB MIN
CROSSTALK (TX-RX)	1 MHz	5-100 MHz
	-62 dB MIN	-45 + 21LOG ₁₀ (f/30 MHz) dB MIN
DIFFERENTIAL TO COMMON MODE REJECTION	5-200 MHz	
	-50 + 17LOG ₁₀ (f/5 MHz) dB MIN	
WORKING VOLTAGE	600 VDC FOR 15 YEARS	
INPUT - OUTPUT ISOLATION	2500 VRMS MINIMUM FOR 60 SECONDS	

NOTE: f IS FREQUENCY IN MHZ.

© Copyright, 2017. Pulse Electronics Corp. All rights reserved. Pulse confidential & proprietary. (10/18/17)

PRODUCT DESCRIPTION	TLA DRAWING	PS DRAWING	SHEET	PART NO.	DATASHEET REV.
TRANSFORMER/CMC,3.2kVDC ISO,SGL,SM	HM1237NL-10	PS-2755.002-A	2 OF 3	HM1237NL	F

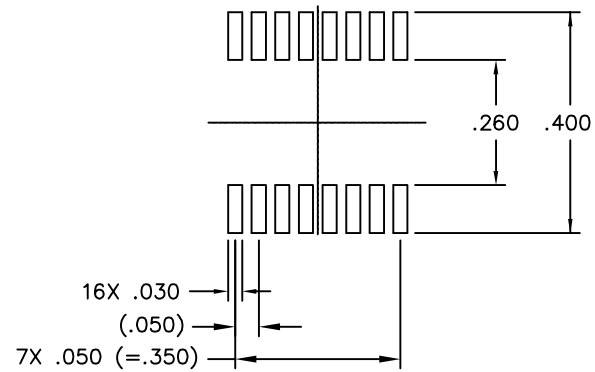
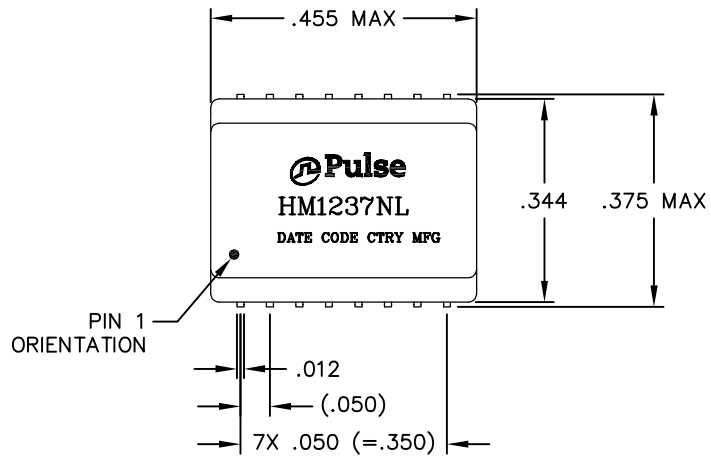

SUGGESTED LAND PATTERN

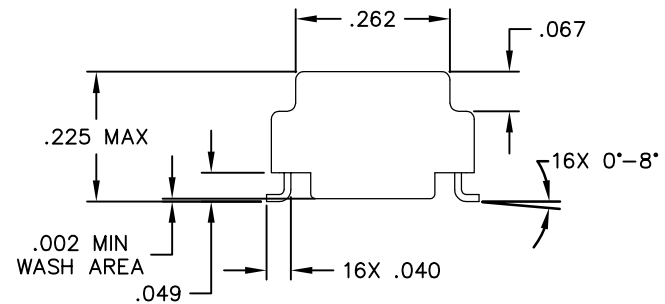
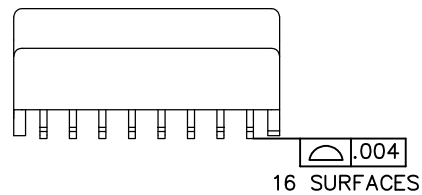

DIMENSIONS ARE IN INCHES WITH THE FOLLOWING
TOLERANCES:
.XX= ±.01
.XXX= ±.005

© Copyright, 2017. Pulse Electronics Corp. All rights reserved. Pulse confidential & proprietary. (10/18/17)

PRODUCT DESCRIPTION	TLA DRAWING	PS DRAWING	SHEET	PART NO.	DATASHEET REV.
TRANSFORMER/CMC,3.2kVDC ISO,SGL,SM	HM1237NL-10	PS-2755.002-A	3 OF 3	HM1237NL	F