



# MPQ3369

## 6-Channel, Maximum 100mA/Ch Boost WLED Driver with 15000:1 Dim Ratio and I<sup>2</sup>C

### DESCRIPTION

The MPQ3369 is a step-up converter with six channel current sources. It is designed to drive white LED arrays as backlighting for small- or medium-sized LCD panels.

The device uses peak current mode as its PWM control architecture to regulate the boost converter. Six channel current sources are applied into the LED cathode to adjust the LED brightness. The MPQ3369 regulates the current in each LED string to the value set via an external current-setting resistor, with 2.5% current regulation accuracy between strings.

A low on resistor MOSFET and a low headroom voltage are provided to improve efficiency. The MPQ3369 has a standard I<sup>2</sup>C digital interface for easy use. The switching frequency can be configured via a resistor, I<sup>2</sup>C interface, or external clock.

The MPQ3369 provides analog, PWM, and mix dimming modes with a PWM input. The dimming mode can be selected with the I<sup>2</sup>C interface or the MIX/AD pin. The device also has a phase shift function to eliminate noise during PWM dimming.

Robust protections guarantee safe operation of the device, and include over-current protection (OCP), over-voltage protection (OVP), over-temperature protection (OTP), and LED short and open protection. The MPQ3369 can also be configured to automatically decrease the LED current at high temperatures.

The MPQ3369 is available in a QFN-24 (4mmx4mm) package.

### FEATURES

- 3.5V to 36V Input Voltage Range
- 6 Channels with Max 100mA per Channel
- Internal 100mΩ, 50V MOSFET
- Configurable Switching Frequency Up to 2.2MHz
- External Sync SW Function
- Multi-Dimming Operation Mode through PWM Input, Including:
  - Direct PWM Dimming
  - Analog Dimming
  - Mix Dimming with 25% or 12.5% Transfer Point
- 15000:1 Dimming Ratio in PWM Dimming at  $f_{PWM} \leq 200\text{Hz}$
- 200:1 Dimming Ratio at Analog Dimming through PWM Dimming Signal Input
- Excellent EMI Performance, Frequency Spread Spectrum
- I<sup>2</sup>C Interface
- Phase Shift Function for PWM Dimming
- 2.5% Current Matching
- Cycle-by-Cycle Current Limit
- Disconnect VOUT from VIN
- Optional LED Current Auto-Decrement at High Temperatures
- LED Short/Open, OTP, OCP, Inductor Short Protection
- Configurable LED Short Threshold
- Configurable OVP Threshold
- Fault Indicator Signal Output
- Allow to Connect Multiple LEDx Pins for One LED String
- Available in a QFN-24 (4mmx4mm) Package

### APPLICATIONS

- Tablets/Notebooks
- Automotive Displays

All MPS parts are lead-free, halogen-free, and adhere to the RoHS directive. For MPS green status, please visit the MPS website under Quality Assurance. "MPS", the MPS logo, and "Simple, Easy Solutions" are trademarks of Monolithic Power Systems, Inc. or its subsidiaries.



### ORDERING INFORMATION

Part Number*	Package	Top Marking	MSL Rating
MPQ3369GR*	QFN-24 (4mmx4mm)	See Below	1

\* For Tape & Reel, add suffix -Z (e.g. MPQ3369GR - Z).

### TOP MARKING

MPSYWW

MP3369

LLLLLL

MPS: MPS prefix  
 Y: Year code  
 WW: Week code  
 MP3369: Part number  
 LLLLLL: Lot number

### PACKAGE REFERENCE

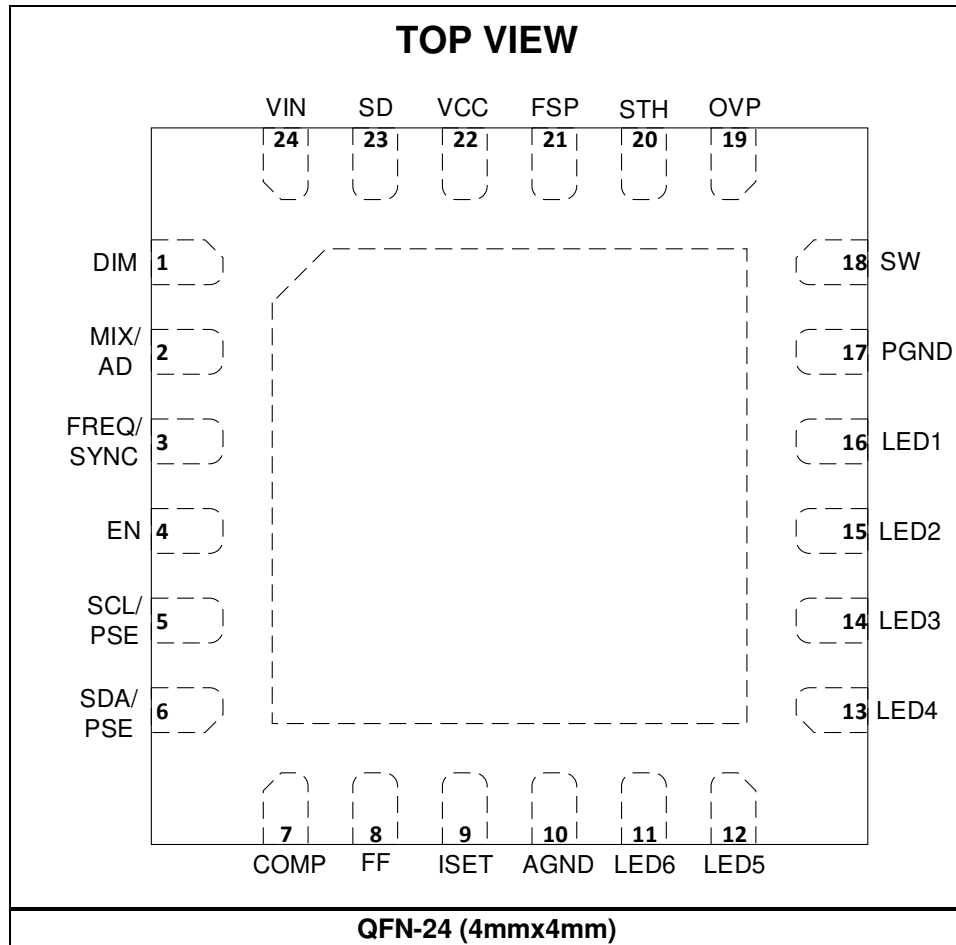

## PIN FUNCTIONS

Pin #	Name	Description
1	DIM	<b>PWM signal input pin.</b> Apply a PWM signal on DIM for brightness control. This pin is pulled low internally. It is recommended to set the PWM signal between 100Hz and 20kHz.
2	MIX/AD	<b>Dimming mode set pin.</b> MIX/AD is a current-source output (18μA). Connect a resistor to MIX/AD to program its voltage. When MIX/AD is at a low level (<0.3V), the device uses mix dimming. When MIX/AD is at a middle level (0.5V to 0.8V), the device uses PWM dimming. When MIX/AD is at a high level (1.0V to 1.3V), the device uses analog dimming. When MIX/AD is floating, the dimming mode is set by the internal MODE register.
3	FREQ/ SYNC	<b>Switching frequency setting and SYNC pin.</b> The switching frequency is determined by the voltage and current on this pin. Connect a resistor between FREQ/SYNC and GND to set the converter's switching frequency, or connect an external clock to the sync boost switching frequency. Leave FREQ/SYNC floating if the internal switching frequency is set by register FSW1:0.
4	EN	<b>IC enable pin.</b> Pull EN high to enable the IC. When EN is pulled low, the IC shuts down.
5	SCL/PSE	<b>I<sup>2</sup>C interface clock input pin.</b> To enable the phase shift PWM dimming function, tie SDA/PSE to SCL/PSE and pull up both pins between 0.75V and 1V.
6	SDA/PSE	<b>I<sup>2</sup>C interface data input pin.</b> To enable the phase shift PWM dimming function, tie SCL/PSE to SDA/PSE and pull up both pins between 0.75V and 1V.
7	COMP	<b>Compensation pin.</b>
8	FF	<b>Fault flag pin.</b> Open drain during normal operation. FF pulls low when any fault is triggered.
9	ISET	<b>LED current setting.</b> Tie a current-setting resistor from ISET to GND to program the current in each LED string.
10	AGND	<b>Analog ground.</b>
11	LED6	<b>LED string 6 current input.</b> Connect the LED string 6 cathode to this pin.
12	LED5	<b>LED string 5 current input.</b> Connect the LED string 5 cathode to this pin.
13	LED4	<b>LED string 4 current input.</b> Connect the LED string 4 cathode to this pin.
14	LED3	<b>LED string 3 current input.</b> Connect the LED string 3 cathode to this pin.
15	LED2	<b>LED string 2 current input.</b> Connect the LED string 2 cathode to this pin.
16	LED1	<b>LED string 1 current input.</b> Connect the LED string 1 cathode to this pin.
17	PGND	<b>Power ground.</b>
18	SW	<b>Drain for the internal low-side MOSFET switch.</b> Connect the power inductor to SW.
19	OVP	<b>Over-voltage protection pin.</b> Connect a resistor divider from OVP to GND to program the over-voltage protection (OVP) threshold.
20	STH	<b>Short LED protection threshold set pin.</b> STH is a current-source output (18μA). Connect a resistor to STH to program its voltage. Float this pin if the internal short LED protection threshold is set by register TH_S 1:0.
21	FSP	<b>Switching frequency spread spectrum pin.</b> FSP is a current-source output (18μA). Connect a resistor to program its voltage. Float this pin if using the internal register setting.
22	VCC	<b>5V LDO output pin.</b> VCC provides power for the internal logic and gate driver. Place a ceramic capacitor as close to this pin as possible to reduce noise.
23	SD	<b>External disconnect PMOS gate drive pin.</b> This pin turns off the external PMOS if a fault occurs. Float this pin if not used.
24	VIN	<b>Power supply input.</b> VIN supplies power to the IC.
Exposed pad	AGND	<b>Chip ground.</b> Connect exposed pad to AGND.

**ABSOLUTE MAXIMUM RATINGS** <sup>(1)</sup>

V <sub>IN</sub> .....	-0.3V to +42V
V <sub>SW</sub> , V <sub>LED1</sub> to V <sub>LED6</sub> .....	-0.5V to +50V
V <sub>SW</sub> .....	-1.0V for <100ns
V <sub>SD</sub> .....	V <sub>IN</sub> - 6V to V <sub>IN</sub>
All other pins .....	-0.3V to +6V
Junction temperature .....	150°C
Lead temperature .....	260°C
Continuous power dissipation (T <sub>A</sub> = 25°C) <sup>(2)</sup>	
QFN-24 (4mmx4mm) .....	2.97W

**ESD Rating**

Human body model (HBM)	
LED1-6 ESD .....	8kV
All other pins .....	2kV
Charged device model (CDM) .....	2kV

**Recommended Operating Conditions** <sup>(3)</sup>

Supply voltage (V <sub>IN</sub> ) .....	3.5V to 36V
Operating junction temp (T <sub>J</sub> ) ....	-40°C to +125°C

<b>Thermal Resistance</b> <sup>(4)</sup>	<b>θ<sub>JA</sub></b>	<b>θ<sub>JC</sub></b>
QFN-24 (4mmx4mm) .....	42	9

**Notes:**

- 1) Exceeding these ratings may damage the device.
- 2) The maximum allowable power dissipation is a function of the maximum junction temperature, T<sub>J</sub> (MAX), the junction-to-ambient thermal resistance, θ<sub>JA</sub>, and the ambient temperature, T<sub>A</sub>. The maximum allowable continuous power dissipation at any ambient temperature is calculated by P<sub>D</sub> (MAX) = (T<sub>J</sub> (MAX) - T<sub>A</sub>) / θ<sub>JA</sub>. Exceeding the maximum allowable power dissipation will cause excessive die temperature, and the regulator will go into thermal shutdown. Internal thermal shutdown circuitry protects the device from permanent damage.
- 3) The device is not guaranteed to function outside of its operating conditions.
- 4) Measured on JESD51-7, 4-layer PCB.

## ELECTRICAL CHARACTERISTICS

V<sub>IN</sub> = 12V, V<sub>EN</sub> = 2V, T<sub>J</sub> = -40°C to +125°C, typical value is at T<sub>J</sub> = 25°C, unless otherwise noted.

Parameter	Symbol	Condition	Min	Typ	Max	Units
Operating input voltage	V <sub>IN</sub>		3.5		36	V
Supply current (quiescent)	I <sub>Q</sub>	No switching		5		mA
Supply current (shutdown)	I <sub>ST</sub>	V <sub>EN</sub> = 0V, V <sub>IN</sub> = 12V			1	μA
Input UVLO threshold	V <sub>IN_UVLO</sub>	Rising edge		3.1		V
Input UVLO hysteresis				100		mV
LDO output voltage	V <sub>CC</sub>	V <sub>EN</sub> = 2V, 6V < V <sub>IN</sub> < 24V, 0 < I <sub>VCC</sub> < 10mA		5		V
EN on threshold	V <sub>EN_ON</sub>	V <sub>EN</sub> rising	1.2			V
EN off threshold	V <sub>EN_OFF</sub>	V <sub>EN</sub> falling			0.4	V
EN pull-down resistance	R <sub>EN</sub>			1		MΩ
<b>Step-Up Converter</b>						
Low-side MOSFET on resistance	R <sub>D<sub>LS</sub></sub>	V <sub>IN</sub> = 12V		100		mΩ
SW leakage current	I <sub>SW_LK</sub>	V <sub>SW</sub> = 45V			1	μA
Switching frequency	f <sub>SW</sub>	R <sub>FREQ</sub> = 10kΩ	1.98	2.2	2.42	MHz
		R <sub>FREQ</sub> = 40kΩ	495	550	605	kHz
		FSW1:0 = 01, FREQ float	340	400	460	kHz
FREQ voltage	V <sub>FREQ</sub>		0.57	0.6	0.63	V
FSP pull-up current	I <sub>FSP</sub>			18		μA
Maximum duty cycle	D <sub>MAX</sub>	f <sub>SW</sub> = 1MHz	90			%
Cycle-by-cycle current limit	I <sub>SW_LIMIT</sub>	T <sub>J</sub> = 25°C, 90% duty cycle	2.6			A
		90% duty cycle	2.3			A
Current limit protection	I <sub>CL</sub>	To trigger current limit protection		7.5		A
SYNC input low threshold	V <sub>SYNC_LO</sub>	V <sub>SYNC</sub> falling			0.4	V
SYNC input high threshold	V <sub>SYNC_HI</sub>	V <sub>SYNC</sub> rising	1.2			V
PSE active threshold	V <sub>PSE</sub>	Phase shift enabled	0.75	0.9	1.0	V
COMP transconductance	G <sub>COMP</sub>	ΔI <sub>COMP</sub> ≤ 10μA		100		μA/V
COMP source current limit	I <sub>COMP_SO</sub>			90		μA
COMP sink current limit	I <sub>COMP_SI</sub>			30		μA
<b>Current Dimming</b>						
DIM input low threshold	V <sub>DIM_LO</sub>	V <sub>DIM</sub> falling			0.4	V
DIM input high threshold	V <sub>DIM_HI</sub>	V <sub>DIM</sub> rising	1.2			V
MIX/AD input low threshold	V <sub>MIX_LO</sub>	Mix dimming threshold			0.3	V
MIX/AD input middle threshold	V <sub>MIX_MID</sub>	PWM dimming threshold	0.5		0.8	V
MIX/AD input high threshold	V <sub>MIX_HI</sub>	Analog dimming threshold	1.0		1.3	V

**ELECTRICAL CHARACTERISTICS (continued)**
**V<sub>IN</sub> = 12V, V<sub>EN</sub> = 2V, T<sub>J</sub> = -40°C to +125°C, typical value is at T<sub>J</sub> = 25°C, unless otherwise noted.**

Parameter	Symbol	Condition	Min	Typ	Max	Units
MIX/AD pull-up current	I <sub>MIX</sub>	MIX/AD pull-up current		18		μA
Mix dimming transfer point		MIXTP bit = 0		25		%
Transfer point hysteresis				0.5		%
Mix dimming output dimming frequency	f <sub>MIX</sub>	MIXFR bit = 0		200		Hz
<b>LED Current Regulator</b>						
LEDx regulation voltage	V <sub>HD</sub>	I <sub>LED</sub> = 20mA		350		mV
		I <sub>LED</sub> = 100mA		850	1000	mV
Current matching <sup>(5)</sup>		I <sub>LED</sub> = 20mA	-2.5		+2.5	%
		I <sub>LED</sub> = 100mA	-2.5		+2.5	%
ISET voltage	V <sub>ISET</sub>			1.2		V
LED current	I <sub>LED</sub>	R <sub>ISET</sub> = 24.9kΩ	48.75	50	51.25	mA
		I <sub>LED</sub> = 1/50 x 50mA = 1mA	0.9	1.05	1.2	mA
Phase shift degree		LED1 to 6 enable		60		°
		LED1 to 4 enable		90		°
<b>Protection</b>						
Over-voltage protection threshold	V <sub>OVP</sub>		1.9	2	2.1	V
OVP hysteresis				200		mV
OVP UVLO threshold	V <sub>OVP_UV</sub>	Step-up converter fails		100		mV
LEDx over-voltage threshold	V <sub>LEDX_OV</sub>	LEDS bits = 01		5		V
LEDx over-voltage fault timer				7.7		ms
LEDx UVLO threshold	V <sub>LEDX_UV</sub>			100		mV
Thermal shutdown threshold <sup>(6)</sup>	T <sub>ST</sub>	Rising edge		170		°C
		Hysteresis		20		°C
SD pull-down current	I <sub>SD</sub>			60		μA
SD voltage (relative to V <sub>IN</sub> )	V <sub>SD-IN</sub>	V <sub>IN</sub> = 12V, V <sub>IN</sub> - V <sub>SD</sub>		6		V
STH pull-up current	I <sub>STH</sub>	STH pull-up current		18		μA
<b>I<sup>2</sup>C Interface</b>						
Input logic low	V <sub>IL</sub>				0.4	V
Input logic high	V <sub>IH</sub>		1.2			V
Output logic low	V <sub>OL</sub>	I <sub>LOAD</sub> = 3mA			0.4	V
SCL clock frequency	f <sub>SCL</sub>				400	kHz
SCL high time	t <sub>HIGH</sub>		0.6			μs
SCL low time	t <sub>LOW</sub>		1.3			μs
Data set-up time	t <sub>SU,DAT</sub>		100			ns
Data hold time	t <sub>HD,DAT</sub>		0		0.9	μs
Set-up time for repeated start	t <sub>SU,STA</sub>		0.6			μs

## ELECTRICAL CHARACTERISTICS *(continued)*

V<sub>IN</sub> = 12V, V<sub>EN</sub> = 2V, T<sub>J</sub> = -40°C to +125°C, typical value is at T<sub>J</sub> = 25°C, unless otherwise noted.

Parameter	Symbol	Condition	Min	Typ	Max	Units
Hold time for start	t <sub>HD,STA</sub>		0.6			μs
Bus free time between start and stop condition	t <sub>BUF</sub>		1.3			ms
Set-up time for stop condition	t <sub>SU,STO</sub>		0.6			μs
Rise time of SCL and SDA	t <sub>R</sub>		20 + 0.1 x C <sub>B</sub>		300	ns
Fall time of SCL and SDA	t <sub>F</sub>		20 + 0.1 x C <sub>B</sub>		300	ns
Pulse width of suppressed spike	t <sub>SP</sub>		0		50	ns
Capacitance bus for each bus line	C <sub>B</sub>				400	pF

### Notes:

- 5) Matching is defined as the difference of the maximum to minimum current divided by 2 times the average current.
- 6) Guarantee by design.

## I<sup>2</sup>C-COMPATIBLE INTERFACE TIMING DIAGRAM

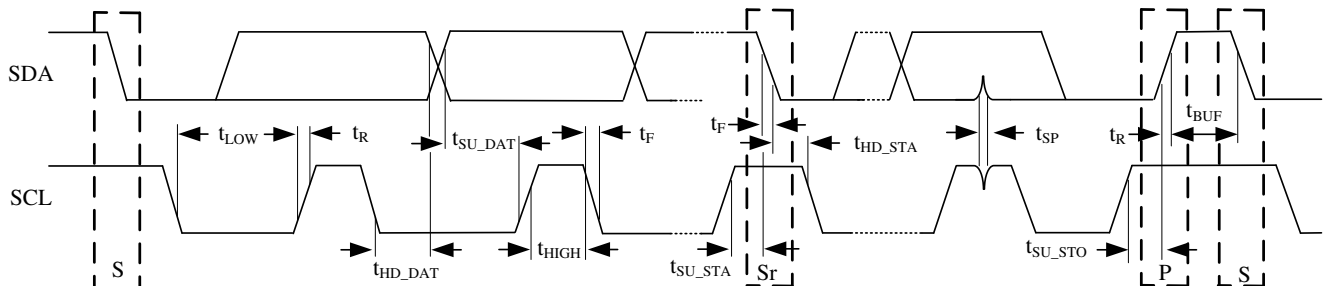

S = START CONDITION

S<sub>r</sub> = REPEATED START CONDITION

P = STOP CONDITION



## TYPICAL PERFORMANCE CHARACTERISTICS

$V_{IN} = 12V$ ,  $L = 22\mu H$ , LED = 6P12S,  $f_{SW} = 400kHz$ ,  $I_{SET} = 50mA$ ,  $T_A = 25^\circ C$ , unless otherwise noted.

### Steady State

$f_{sw} = 400kHz$

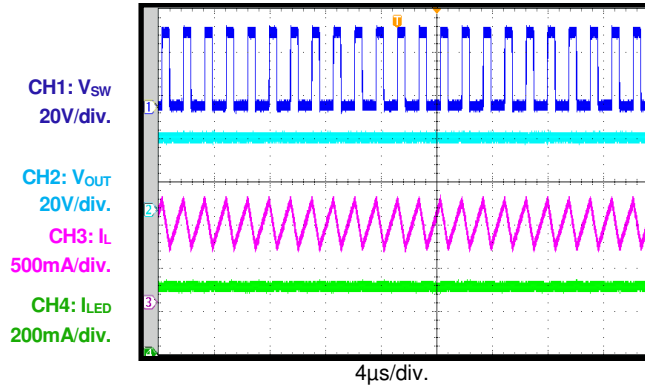

### Steady State

$f_{sw} = 2.2MHz$

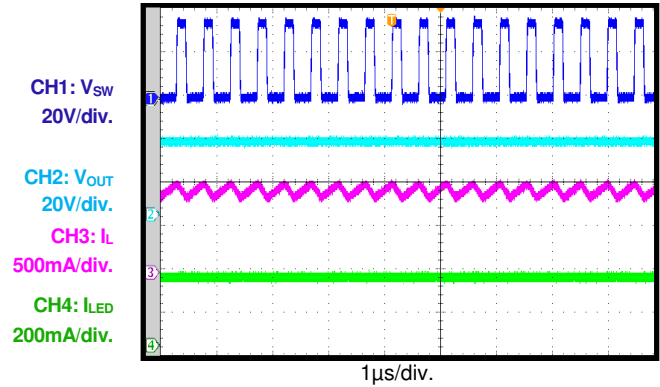

### VIN Power On

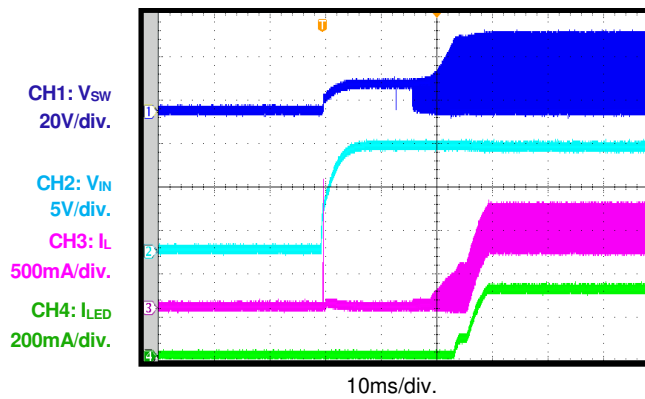

### EN Power On

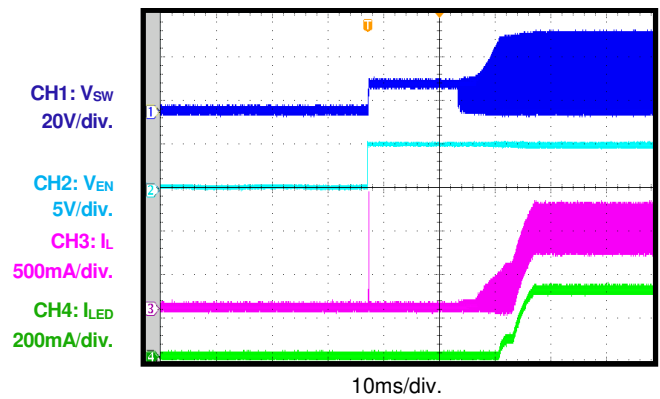

### PWM Dimming

$f_{PWM} = 200Hz$ , 50% duty cycle

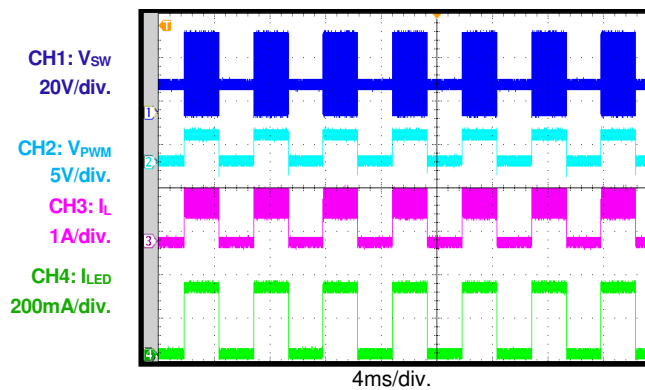

### PWM Dimming

$f_{PWM} = 20kHz$ , 50% duty cycle

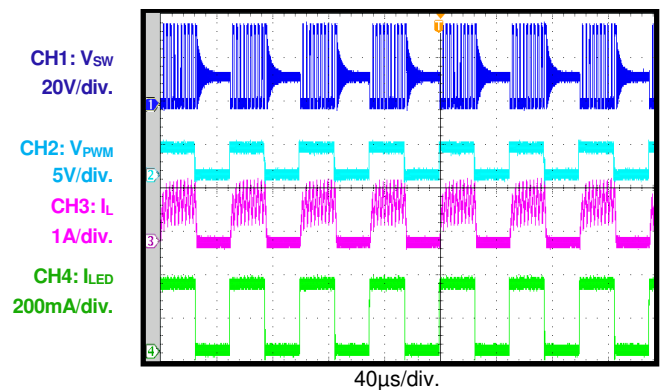

**TYPICAL PERFORMANCE CHARACTERISTICS (continued)**
 $V_{IN} = 12V$ ,  $L = 22\mu H$ , LED = 6P12S,  $f_{SW} = 400kHz$ ,  $I_{SET} = 50mA$ ,  $T_A = 25^\circ C$ , unless otherwise noted.

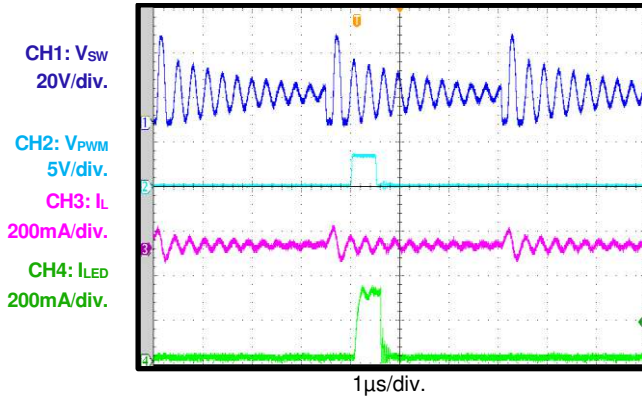
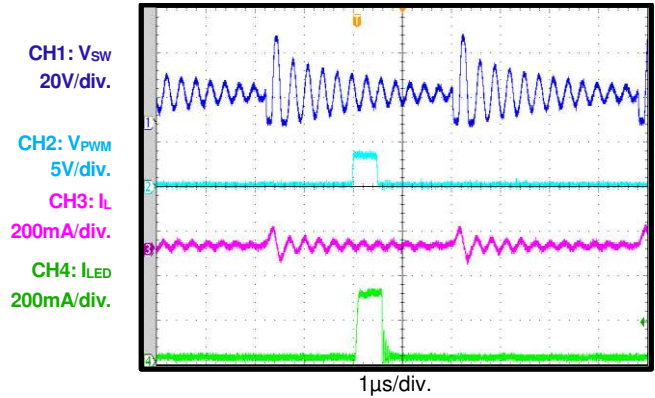
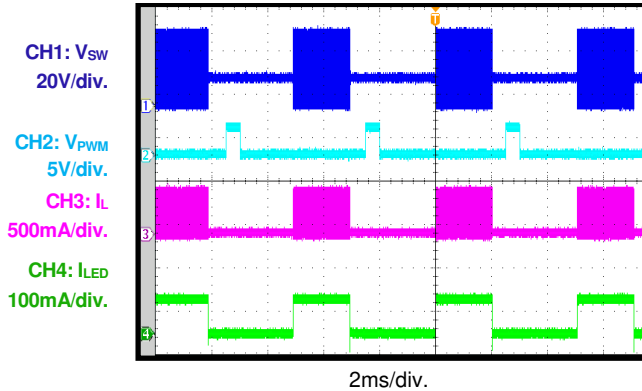
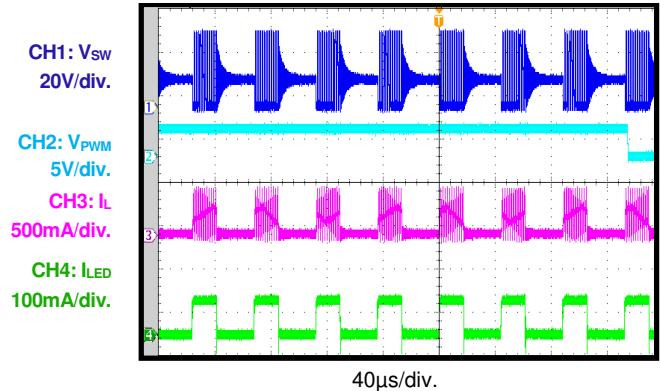
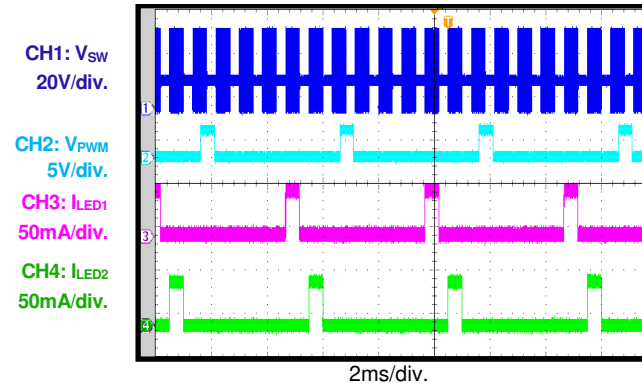
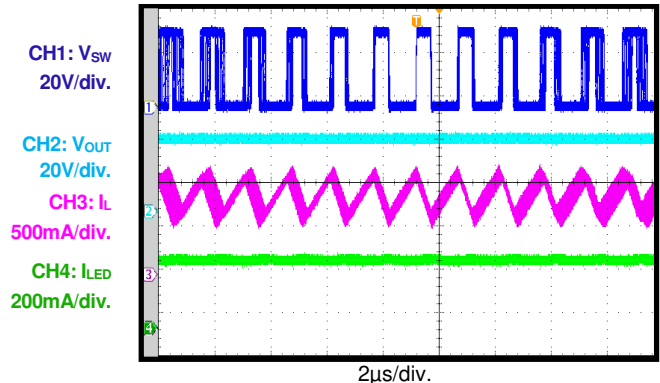
**PWM Dimming**
 $f_{PWM} = 200Hz$ , 0.01% duty cycle

**PWM Dimming**
 $f_{PWM} = 100Hz$ , 0.005% duty cycle

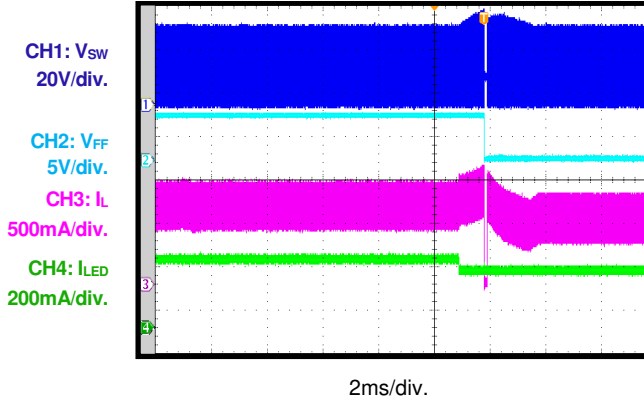
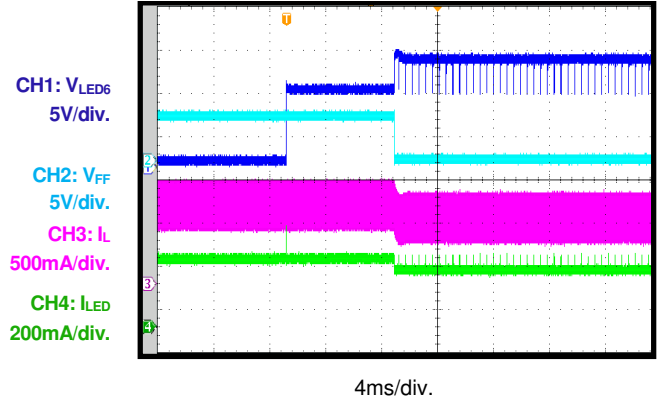
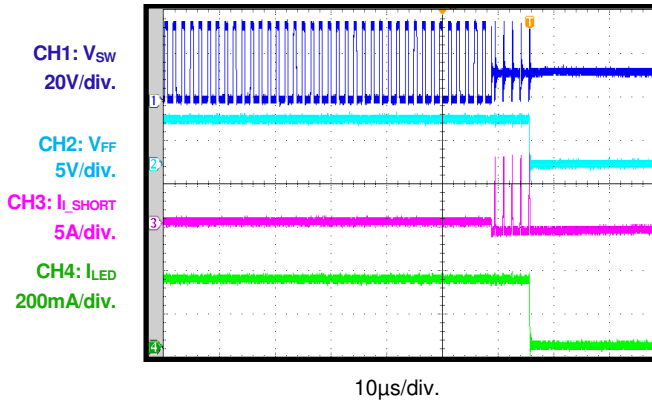
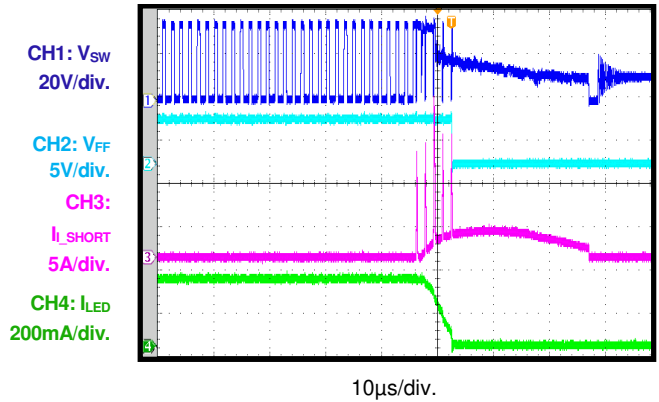
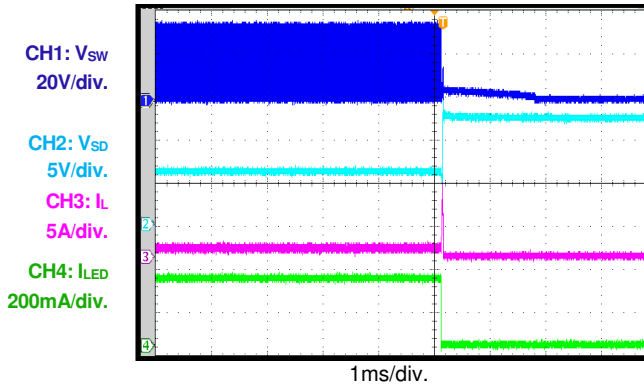
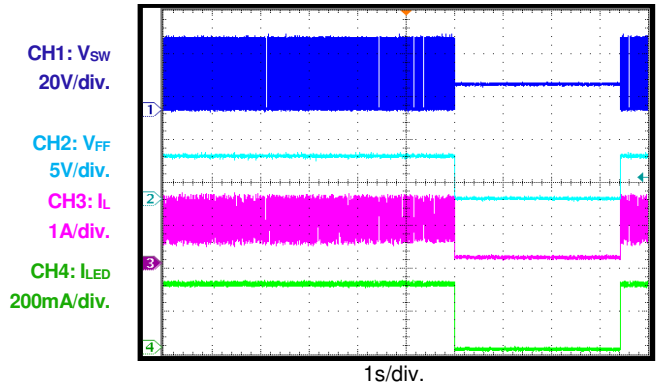
**Mix Dimming**
 $f_{PWM} = f_{(ILED)} = 200Hz$ , 10% duty cycle

**Mix Dimming**
 $f_{PWM} = 200Hz$ ,  $f_{(ILED)} = 23kHz$ , 10% duty cycle

**Phase Shift Function**
 $f_{PWM} = 200Hz$ , PWM dimming,  
6-channel enable

**Frequency Spread Spectrum**
 $f_{PWM} = 400Hz$ , 1/100 of center frequency

**TYPICAL PERFORMANCE CHARACTERISTICS (continued)**
 $V_{IN} = 12V$ ,  $L = 22\mu H$ , LED = 6P12S,  $f_{SW} = 400kHz$ ,  $I_{SET} = 50mA$ ,  $T_A = 25^\circ C$ , unless otherwise noted.

**Open LED Protection**  
 Open 1 string when working

**Short LED Protection**  
 Short 1 string when working

**Short Inductor Protection**

**Short Diode Protection**

**Short VOUT to GND Protection**

**Thermal Protection**

### FUNCTIONAL BLOCK DIAGRAM

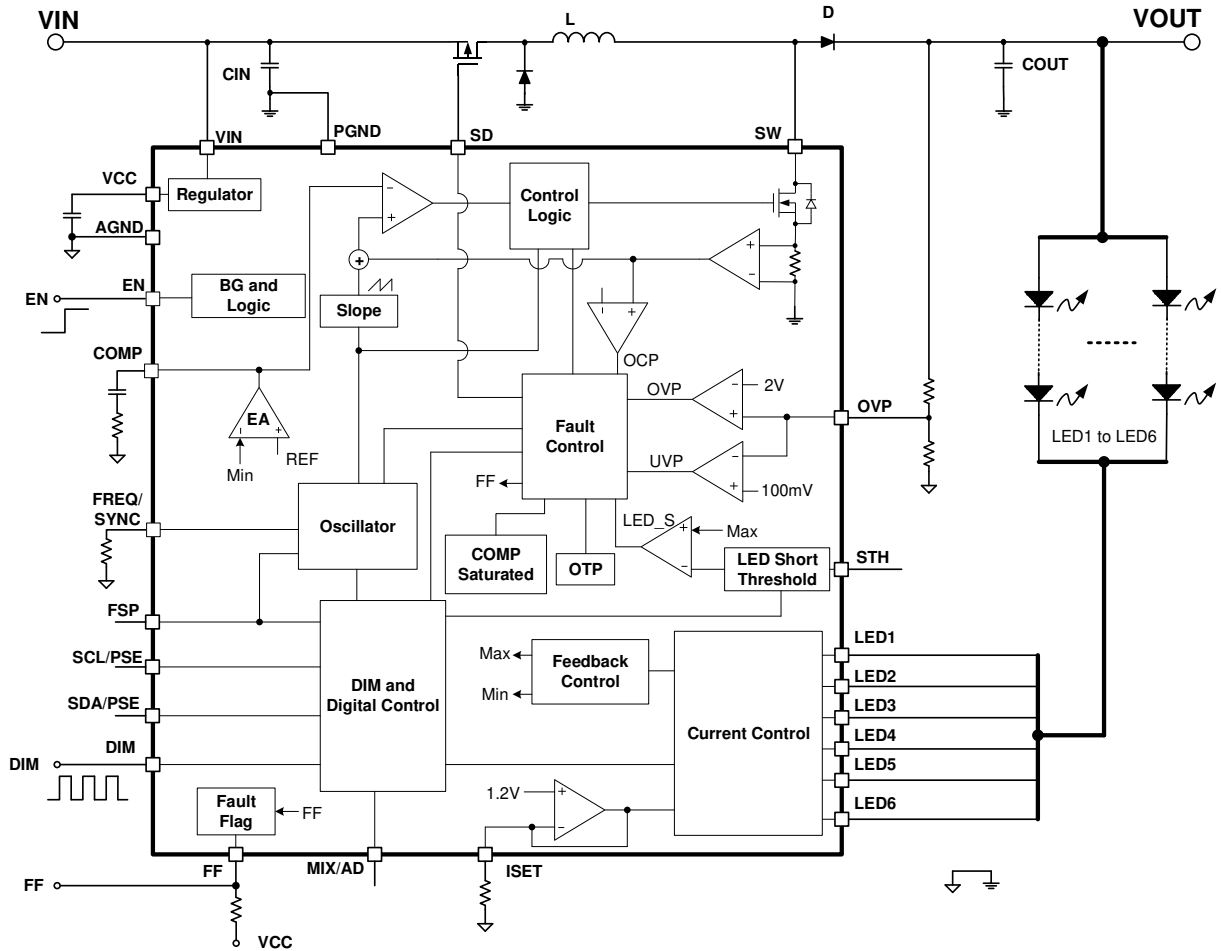

Figure 1: Functional Block Diagram

## OPERATION

The MPQ3369 is a configurable, constant-frequency, peak current mode, step-up converter with up to six channels of regulated current sources to drive an array of white LEDs.

### Internal 5V Regulator

The MPQ3369 has an internal linear regulator (VCC). When  $V_{IN}$  exceeds 6V, the regulator outputs a 5V power supply to the internal MOSFET switch gate driver and internal control circuitry. The VCC voltage drops to 0V when the chip shuts down. The chip remains disabled until VCC exceeds the under-voltage lockout (UVLO) threshold.

### System Start-Up

When enabled, the MPQ3369 checks the topology connection. The IC draws current from SD to enable the input disconnect PMOS to be turned on (if this PMOS is used).

After a 500 $\mu$ s delay, the IC monitors the OVP pin to see if the output is shorted to GND. If the OVP pin voltage is below 100mV, the IC is disabled and latches off. The MPQ3369 then continues to check other safety limits (e.g. LED open, over-voltage protection). If all protection tests pass, the IC starts boosting the step-up converter with an internal soft start.

The recommended start-up sequence is:

1.  $V_{IN}$
2. EN
3. I<sup>2</sup>C (optional)
4. PWM dimming signal

### Step-Up Converter

The MPQ3369 employs peak current mode control to regulate the output energy. At the beginning of each switching cycle, the internal clock turns on the internal N-channel MOSFET. In normal operation, the minimum turn-on time is about 100ns.

To prevent subharmonic oscillations for duty cycles greater than 50%, add a stabilizing ramp to the output of the current-sense amplifier. This result is fed into the PWM comparator. When the summed voltage reaches the output voltage of the error amplifier, the internal MOSFET turns off.

The output voltage of the internal error amplifier is an amplified signal of the difference between the reference voltage ( $V_{REF}$ ) and the feedback voltage ( $V_{FB}$ ). The converter automatically chooses the lowest active LEDx pin voltage to provide a sufficient output voltage to power all the LED arrays.

If  $V_{FB}$  drops below  $V_{REF}$ , the output of the error amplifier increases. More current flows through the MOSFET, which increases the power delivered to the output. This forms a closed loop that regulates the output voltage.

During light-load operation (e.g. when  $V_{OUT}$  is approximately equal to  $V_{IN}$ ), the converter runs in pulse-skip mode. In this mode, the MOSFET turns on for a minimum on time, then the converter discharges the power to the output for the remaining period. The external MOSFET remains off until the output voltage requires a boost.

### Dimming Control

The MPQ3369 provides analog, PWM, and mix dimming mode. The dimming mode can be set with the I<sup>2</sup>C, or by connecting a resistor to MIX/AD. The MIX/AD voltage is calculated with Equation (1):

$$V_{MIX/AD}(mV) = 18(\mu A) \times R_{MIX/AD}(k\Omega) \quad (1)$$

Where  $V_{MIX/AD}$  is the voltage on MIX/AD, and  $R_{MIX/AD}$  is the resistor at MIX/AD.

### Mix Dimming Mode

The MPQ3369 works in mix dimming mode with 12.5% or 25% as its transfer points (selected through the internal register). There are two methods to force the MPQ3367 into mix dimming mode:

1. The first method is to connect a resistor to the MIX/AD pin and set its voltage below 0.3V.
2. The second is to float MIX/AD and set the internal mode selection register (MODE1:0) to 00 through the I<sup>2</sup>C.

A PWM dimming signal is applied to DIM. When the dimming duty exceeds 25%, analog dimming is activated and the LED current amplitude follows the PWM duty.

When the dimming duty drops below 25%, PWM dimming is activated (see Figure 2). The LED current amplitude ( $I_{LED}$ ) remains at 1/4 of the full-scale current, and the output dimming duty is 4 times the duty of the input PWM signal.

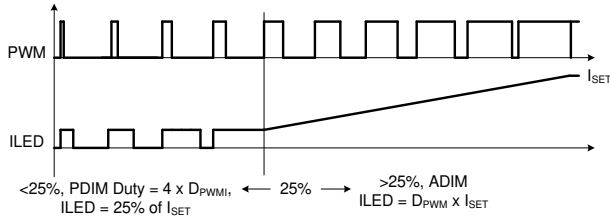

**Figure 2: Mix Dimming with 25% Transfer Point**

There are two options for the output dimming frequency when the device operates in mix dimming mode: 200Hz (default) or 23kHz (no audible noise, but larger minimum dimming duty). This does not change based on the input PWM dimming frequency. The output dimming frequency is selected with the mix dimming output frequency selection bit (MIXFR) via the I<sup>2</sup>C.

This function eliminates audible noise and improves the dimming performance in small dimming ratio. **Direct PWM Dimming**

For direct PWM dimming, use a resistor to set MIX/AD to a middle level (0.5V to 0.8V), or float MIX/AD and set the internal mode select register (MODE1:0) to 01 through the I<sup>2</sup>C.

When a PWM signal is applied to DIM, the amplitude of the LED current ( $I_{LED}$ ) remains at the LED full scale, and  $I_{LED}$  is reduced by the input PWM signal. The LED current duty follows the PWM input duty, and the LED current frequency is equal to the PWM input.

### Analog Dimming Mode

For analog dimming mode, use a resistor to set MIX/AD to a high level (1V to 1.3V), or float MIX/AD and set the internal mode selection register (MODE) to 10 through the I<sup>2</sup>C.

The PWM input signal is calculated by an internal counter. The amplitude of the LED current is equal to  $I_{SET} \times D_{DIM}$ , where  $I_{SET}$  is the full-scale LED current, and  $D_{DIM}$  is the duty of the input PWM signal. To improve analog dimming performance, it is recommended to set the PWM signal between 100Hz and 20kHz.

To ensure good performance with a small dimming ratio, the minimum LEDx voltage shifts up to 2V when the dimming duty is below 10%. Analog dimming supports a 200:1 dimming ratio.

### Deep Dimming Ratio for PWM Dimming

When the output dimming on time is shorter than 7 $\mu$ s, the output voltage is regulated to 93% of the OVP voltage (see Figure 3).

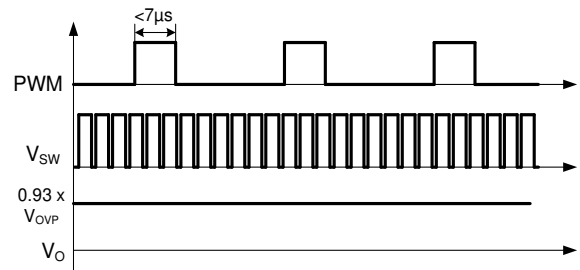

**Figure 3: Deep Dimming Ratio for PWM Dimming**

### Unused LED Channel Setting

If the LEDx pin of an unused channel is connected to GND, the MPQ3367 can automatically detect the unused LED string and remove it from the control loop during start-up. If employing 5 strings, connect the LED6 pin to GND. If using 4 strings, connect LED5 and LED6 to GND, and so on.

The MPQ3369 can also disable the unused string via the internal register (CH2:0 bit):

- CH2:0 = 000: All 6 channels are in use
- CH2:0 = 001: LED1 – 5 are in use
- CH2:0 = 010: LED1 – 4 are in use
- CH2:0 = 011: LED1 – 3 are in use
- CH2:0 = 100: LED1–2 are in use
- CH2:0 = 101: LED1 is in use

### Phase Shift Function

To reduce inrush current and eliminate audible noise during PWM dimming, the MPQ3367 employs a phase shift function.

Two methods can be used to enable the phase shift function:

1. The first method is to connect SCL/PSE to SDA/PSE (to about 0.75V to 1V).
2. The second method is to set the internal register PSE bit to 1 through the I<sup>2</sup>C.



The LED channels' current source is phase-shifted when the IC employs PWM dimming. The phase shift is based on which LED channels are in use, calculated with Equation (2):

$$\text{Phase}(\text{°}) = \frac{360}{n}(\text{°}) \quad (2)$$

Where n is the LED channel in use. If all six channels are in use, the shifted phase is 60°. LED1 directly follows the input PWM signal, and LED2 lags 60° behind (see Figure 4).

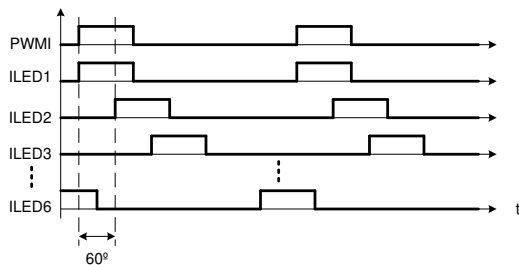

**Figure 4: Phase Shift with 6 Channels**

Figure 5 shows the phase shift function with four channels enabled. The shifted phase in this case is 90°.

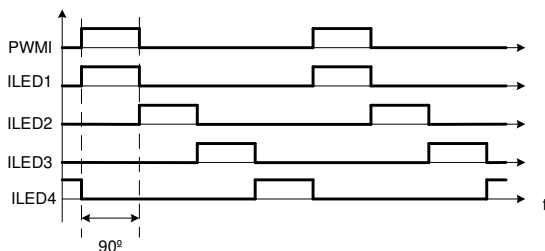

**Figure 5: Phase Shift with 4 Channels**

In phase shift operation, the channels must be disabled in descending order of channel number. For example, if three strings are employed in application, then channels 6, 5, and 4 are disabled.

It is not recommended to tie two channels for one LED string with the phase shift function.

### Frequency Spread Spectrum

The MPQ3369 uses switching frequency jitter to spread the switching frequency spectrum. This reduces the spectrum spike around the switching frequency and its harmonic frequencies.

The modulation frequency is fixed to 1/150 of switching frequency.

The FSP pin can configure the dithering range:

- When FSP is below 0.3V, the jitter frequency is 1/20 of the central frequency
- When FSP is between 0.4V and 1.4V, the jitter frequency is 1/32 of the central frequency

Float FSP to follow the internal I<sup>2</sup>C setting. The frequency jitter range can be selected via the FSPR bit:

- When FSPR = 0 (default), the jitter frequency is 1/20 of the central frequency
- When FSPR = 1, the jitter frequency is 1/32 of the central frequency

Float FSP to follow the internal I<sup>2</sup>C setting. The modulation frequency is selected via the FSPMF1:0 bits.

- When FSPMF1:0 = 00, the modulation frequency is 1/100 of the switching frequency
- When FSPMF1:0 = 01, the modulation frequency is 1/150 of the switching frequency
- When FSPMF1:0 = 10, the modulation frequency is 1/200 of the central frequency
- When FSPMF1:0 = 11 (default), the function is disabled

### Protection

The MPQ3369 includes open LED protection, short LED protection, short LEDx-to-GND protection, over-current protection, short VOUT-to-GND protection, and thermal protection. Once a protection is triggered, FF pulls to GND and the corresponding fault bit is set to 1. After the IC recovers from protection, FF releases to high with a 750µs delay.

### Open LED Protection

Open string protection is achieved by detecting the voltage of the OVP and LEDx pins. If one string is open, and the respective LEDx voltage is low to ground, the IC charges the output voltage until it reaches the over-voltage protection (OVP) threshold.

If OVP is triggered, the chip stops switching and marks off the fault string, which has an LEDx pin voltage below 100mV. Once marked off, the remaining LED strings force the output voltage back into normal regulation. The string with the

largest voltage drop determines the output regulation value.

Open string protection is recoverable. The marked-off string sends a 10µs pulse current to check whether an open fault is removed after every 500µs delay.

### Short String Protection

The MPQ3369 monitors the LEDx voltages to determine whether a short string fault has occurred. When one or more strings are shorted, the respective LEDx pins tolerate high voltage stress. If an LEDx voltage exceeds the short protection threshold, an internal counter starts. When this fault condition lasts for 7.7ms (100% duty cycle), the fault string is marked off. Once a string is marked off, it disconnects from the output voltage loop until the short is removed.

Two methods can be used to set the short protection threshold:

The first method is to connect a resistor at STH. STH outputs an 18µA current source. The short protection threshold is 10 times the voltage on STH. The threshold is calculated using Equation (3):

$$V_{\text{STH}}(\text{V}) = 0.18 \times R_{\text{STH}}(\text{k}\Omega) \quad (3)$$

The second method is to set the internal register (TH\_S1:0) when STH is floating.

When the LEDx voltage exceeds the threshold for 480ms (100% duty cycle), all strings are marked off. The IC remains on standby until the strings are released from shorting. This function can be enabled or disabled through SEN.

Short string protection is recoverable. The marked-off string sends a 10µs pulse current to check if the short fault has been removed after every 500µs delay.

### Short LEDx-to-GND Protection

When LEDx shorts to GND, the COMP voltage increases and saturates. When the COMP voltage is saturated for 20ms or 40ms (this time can be selected by internal register bit TCOMP), the protection is triggered. The IC latches off, FF pulls low, and SD pulls high to turn on the external P-channel MOSFET.

### Short VOUT-to-GND Protection

When VOUT shorts to GND, the output voltage decreases. When the voltage of the OVP pin reaches the OVP pin's under-voltage lockout (UVLO) threshold for 10µs, the protection is triggered, and SD pulls high to turn off the external P-channel MOSFET. VOUT disconnects from VIN, and the IC latches off.

### Cycle-by-Cycle Current Limit

To prevent the external components from exceeding the current stress rating, the IC has cycle-by-cycle current limit protection. When the current exceeds the current limit value, the IC stops switching until the next clock cycle.

### Latch-Off Current Limit Protection

The device may be damaged under extreme conditions, such as an inductor or diode short to GND. To help prevent damage, the MPQ3369 provides a latch-off current limit protection when the current flowing through the internal MOSFET reaches the threshold (7.5A), and lasts for 5 switching cycles.

### Thermal Protection

To prevent the IC from damage when operating at exceedingly high temperatures, the MPQ3369 implements thermal protection by detecting the silicon die temperature.

### Over-Temperature LED Current Decrement

When the die temperature exceeds 140°C, the MPQ3369 automatically decreases the LED current amplitude (I<sub>LED</sub>) (see Figure 6).

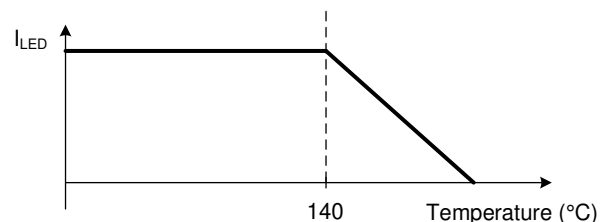

**Figure 6: ILED Decrease with Temperature**

This function is enabled by the over-temperature current decrement bit (OTID):

- When OTID = 0, the over-temperature current decrement is disabled
- When OTID = 1 (default), the over-temperature current decrement is enabled



**Thermal Shutdown**

When the die temperature exceeds the upper threshold (TST), the IC shuts down and resumes normal operation. When the temperature drops below the lower threshold, the IC recovers. The hysteresis value is typically 20°C.

**I<sup>2</sup>C Interface Register Description****I<sup>2</sup>C Chip Address**

The 7-bit MSB device address is 0x38. After the start condition, the I<sup>2</sup>C-compatible master sends a 7-bit address followed by an 8th data direction bit that is either 1 (indicating a read) or 0 (indicating a write).

The following bit indicates the register address to/from which the data will be written/read.

**Table 1: The I<sup>2</sup>C-Compatible Device Address**

0	1	1	1	0	0	0	R/W
---	---	---	---	---	---	---	-----

**REGISTER MAP <sup>(7)</sup>**

Addr	D7	D6	D5	D4	D3	D2	D1	D0
00H	OTID	MODE1	MODE0	MIXTP	MIXFR	FSPMF1	FSPMF0	FSPR
01H	PSEN	TH_S1	TH_S0	FSW1	FSW0	CH2	CH1	CH0
02H	SEN	TCOMP	FT_LEDG	FT_OTP	FT_UVP	FT_OCP	FT_LEDS	FT_LED0
03H	ID7	ID6	ID5	ID4	ID3	ID2	ID1	ID0

**Note:**

7) Leave corresponding pins floating if internal registers are used.

**Register 1**

Addr: 0x00				
Bit	Bit Name	Access	Default	Description
7	OTID	R/W	1	Over-temperature LED current decrement function enable bit. 0: Disabled 1: Enabled
6:5	MODE	R/W	00	Dimming mode selection bit. 00: Mix dimming 01: PWM dimming 10: Analog dimming 11: Reserved Float MIX/AD if this register is being used.
4	MIXTP	R/W	0	Mix dimming transfer point selection bit. 0: 25% transfer point 1: 12.5% transfer point
3	MIXFR	R/W	0	Mix dimming output frequency selection bit. 0: 200Hz 1: 23kHz
2:1	FSPMF1:0	R/W	11	Frequency spread spectrum modulation frequency selection bit. 00: 1/100 of central frequency 01: 1/150 of central frequency 10: 1/200 of central frequency 11: Disable the frequency spread spectrum function Float FSP if this register is being used.
0	FSPR	R/W	0	Frequency spread spectrum jitter range selection bit. 0: 1/20 of central frequency 1: 1/32 of central frequency Float FSP if this register is being used.

**Register 2**

Addr: 0x01				
Bit	Bit Name	Access	Default	Description
7	PSE	R/W	0	Phase shift enable bit. 0: Phase shift disabled 1: Phase shift enabled

6:5	TH_S1:0	R/W	01	LED short protection threshold set bit. 00: 2.5V 01: 5V 10: 7.5V 11: 10V
4:3	FSW1:0	R/W	01	Switching frequency set bit. 00: 200kHz 01: 400kHz 10: 1MHz 11: 2.2MHz  Float FREQ if this register is being used.
2:0	CH2:0	R/W	000	Channel selection bit. 000: All 6 channels are in use 001: LED1–5 are in use 010: LED1–4 are in use 011: LED1–3 are in use 100: LED1–2 are in use 101: LED1 is in use 110, 111: Reserved

### Fault Register

Addr: 0x02				
Bit	Bit Name	Access	Default	Description
7	SEN	R/W	0	Short all LED protection when the PWM duty cycle exceeds 2%. 0: Disable 1: Enable
6	TCOMP	R/W	0	COMP-saturated time select bit for LEDx-to-GND short. 0: 20ms 1: 40ms
5	FT_LEDG	R	0	LEDx short to GND protection fault indication bit. If this short occurs, the fault bit remains set to 1 until a read-back or power reset. 0: No fault 1: Fault  Once this bit is read, the fault status cannot latch off until it is reset to 0.
4	FT_OTP	R	0	Over-temperature protection (OVP) fault indication bit. If OVP occurs, the fault bit is set to 1 until read-back or power reset. 0: No fault 1: Fault  Once this bit is read, the fault status cannot latch off until it is reset to 0.
3	FT_UVP	R	0	Output under-voltage protection (UVP) fault indication bit. If UVP occurs, the fault bit is set to 1 until readback or power reset. 0: No fault 1: Fault  Once this bit is read, the fault status cannot latch off until it is reset to 0.

2	FT_OCP	R	0	Over-current protection (OCP) fault indication bit. If OCP occurs, the fault bit is set to 1 until readback or power reset. 0: No fault 1: Fault Once this bit is read, the fault status cannot latch off until it is reset to 0.
1	FT_LEDS	R	0	LED current source short fault indication bit. If this short occurs, the fault bit is set to 1 until readback or power reset. 0: No fault 1: Fault Once this bit is read, the fault status cannot latch off until it is reset to 0.
0	FT_LED0	R	0	LED current source open fault indication bit. If this fault occurs, the fault bit is set to 1 until readback or power reset. 0: No fault 1: Fault Once this bit is read, the fault status cannot latch off until it is reset to 0.

**Table 4: ID Register**

Addr: 0x03				
Bit	Bit Name	Access	Default	Description
7:0	ID7:0	R	01100111	Device ID bits.

## APPLICATION INFORMATION

### LED Current Setting

The LED current amplitude ( $I_{LED}$ ) is set by an external resistor connected from ISET to GND.  $I_{LED}$  can be estimated with Equation (4):

$$I_{LED}(mA) = \frac{1245}{R_{ISET}(k\Omega)} \quad (4)$$

When  $R_{ISET} = 24.9k\Omega$ , and  $I_{LED} = 50mA$ .

### Switching Frequency

The switching frequency can be configured with a resistor, I<sup>2</sup>C interface, or external clock.

To program the frequency on FREQ/SYNC with an external resistor, the switching frequency can be calculated with Equation (5):

$$f_{sw}(kHz) = \frac{22000}{R_{OSC}(k\Omega)} \quad (5)$$

When  $R_{OSC} = 44.2k\Omega$ ,  $f_{sw} = 500kHz$ .

Synchronize the switching frequency with an external clock to improve EMI, efficiency, and thermal performance.

For details on how to set the switching frequency bit (fSW1:0), see Register Map 2 on page 20. Float FREQ if the fSW1:0 bit is used.

### Selecting the Input Capacitor

The input capacitor reduces the switching noise from the device and the surge current drawn from the input supply. The input capacitor impedance at the switching frequency should be below the input source impedance to prevent the high-frequency switching current from passing through to the input. Ceramic capacitors with X5R or X7R dielectrics are recommended for their low ESR and small temperature coefficients. For most applications, a 10 $\mu$ F ceramic capacitor is sufficient.

### Selecting the Inductor

The MPQ3369 requires an inductor to supply a higher output voltage while being driven by the input voltage. A larger-value inductor results in less ripple current, lower peak inductor current, and less stress on the internal N-channel MOSFET.

However, a larger-value inductor has a larger physical size, higher series resistance, and lower saturation current.

Choose an inductor that does not saturate under worst-case conditions (minimum  $V_{IN}$ , maximum LED current). Select the minimum inductor value to ensure that the boost converter works in continuous conduction mode with high efficiency and good EMI performance.

Calculate the required inductance value with Equation (6):

$$L \geq \frac{\eta \times V_{OUT} \times D \times (1-D)^2}{2 \times f_{sw} \times I_{LOAD}} \quad (6)$$

Where  $V_{OUT}$  is the output voltage,  $f_{sw}$  is the switching frequency,  $I_{LOAD}$  is the LED load current,  $\eta$  is the efficiency, and  $D$  can be estimated with Equation (7):

$$D = 1 - \frac{V_{IN}}{V_{OUT}} \quad (7)$$

Where  $V_{IN}$  is the input voltage.

With the given inductor value, the inductor DC current rating is at least 40% greater than the maximum input peak inductor current for most applications. The inductor's DC resistance should be as small as possible to improve efficiency.

### Selecting the Output Capacitor

The output capacitor keeps the output voltage ripple small and ensures feedback loop stability. The output capacitor impedance must be low at the switching frequency. Ceramic capacitors with X7R dielectrics are recommended for their low ESR. For most applications, a 10 $\mu$ F ceramic capacitor is sufficient.

### PCB Layout Guidelines

Careful attention must be paid to the PCB board layout and components placement. Proper layout of the high-frequency switching path is critical to prevent noise and electromagnetic interference problems.

The IC exposed pad is internally connected to AGND pin, and all logic signals are referred to

the AGND. For the best results, follow the guidelines below:

1. Keep the loop between the SW to PGND pin, output diode, and capacitor as short as possible due to the high-frequency pulse current.
2. Externally connect PGND to AGND.
3. Route PGND away from the logic signals.



**PACKAGE INFORMATION**

**QFN-24 (4mmx4mm)**

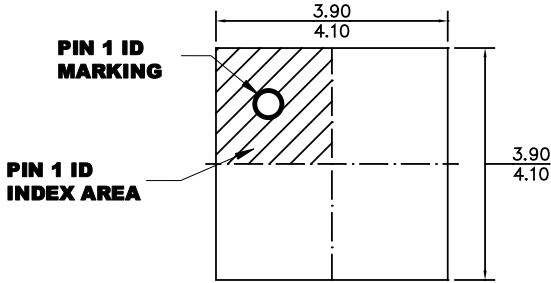

**TOP VIEW**

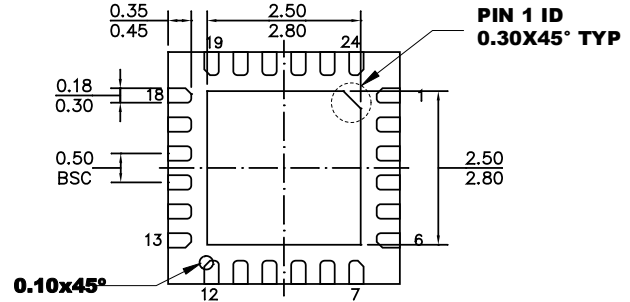

**BOTTOM VIEW**

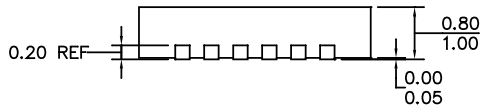

**SIDE VIEW**

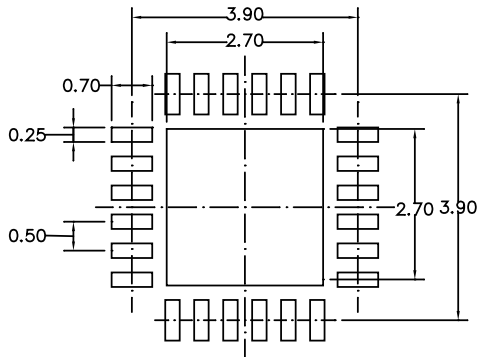

**RECOMMENDED LAND PATTERN**

**NOTE:**

- 1) ALL DIMENSIONS ARE IN MILLIMETERS.
- 2) EXPOSED PADDLE SIZE DOES NOT INCLUDE MOLD FLASH.
- 3) LEAD COPLANARITY SHALL BE 0.08 MILLIMETERS MAX.
- 4) JEDEC REFERENCE IS MO-220.
- 5) DRAWING IS NOT TO SCALE.

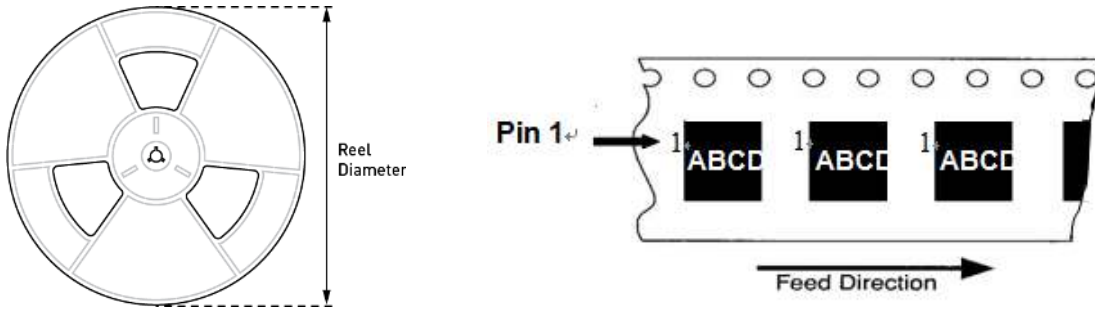

**CARRIER INFORMATION**

Part Number	Package Description	Quantity/ Reel	Quantity/ Tube	Reel Diameter	Carrier Tape Width	Carrier Tape Pitch
MPQ3369GR-Z	QFN-24 (4mmx4mm)	5000	N/A	13in	12mm	8mm

**Notice:** The information in this document is subject to change without notice. Users should warrant and guarantee that third-party Intellectual Property rights are not infringed upon when integrating MPS products into any application. MPS will not assume any legal responsibility for any said applications.