

# SDCLA1V40

## Automotive grade semi-shielded power inductors



### Product features

- AEC-Q200 qualified
- High current carrying capacity
- High power density, low core losses
- Magnetically semi-shielded
- Inductance range from 1  $\mu\text{H}$  to 22  $\mu\text{H}$
- Current range from 0.72 A to 3.2 A
- 4.2 mm x 4.2 mm surface mount package in a maximum 1.8 mm height
- NiZn ferrite magnetic material
- Moisture sensitivity level (MSL): 1

### Applications

- LED lighting
- Advanced driver assistance systems (ADAS)
- Adaptive cruise control (ACC)
- Collision avoidance
- Infotainment and cluster electronics
- Electronic control unit (ECU)

### Environmental compliance and general specifications

- Storage temperature range (component): -55 °C to +125 °C
- Operating temperature range: -55 °C to +125 °C (ambient plus self-temperature rise)
- Solder reflow temperature: J-STD-020 (latest revision) compliant



## Product specifications

Part number <sup>5</sup>	OCL <sup>1</sup> ( $\mu$ H)	Tolerance	FLL <sup>2</sup> ( $\mu$ H) minimum	$I_{DC}$ <sup>3</sup> (A)	$I_{sat}$ <sup>4</sup> (A)	DCR (m $\Omega$ ) $\pm$ 20% @ +25 °C	SRF (MHz) typical
SDCLA1V4018-1R0-R	1.0	$\pm$ 30%	0.49	3.2	4.0	27	90
SDCLA1V4018-1R5-R	1.5	$\pm$ 30%	0.74	2.4	3.3	37	75
SDCLA1V4018-2R2-R	2.2	$\pm$ 20%	1.23	2.2	3.0	42	60
SDCLA1V4018-3R3-R	3.3	$\pm$ 20%	1.85	2.0	2.3	55	46
SDCLA1V4018-4R7-R	4.7	$\pm$ 20%	2.63	1.7	2.0	70	35
SDCLA1V4018-6R8-R	6.8	$\pm$ 20%	3.81	1.45	1.6	98	30
SDCLA1V4018-100-R	10	$\pm$ 20%	5.6	1.2	1.3	150	25
SDCLA1V4018-150-R	15	$\pm$ 20%	8.4	0.85	1.1	210	18
SDCLA1V4018-220-R	22	$\pm$ 20%	12.32	0.72	0.9	290	15

1. Open circuit inductance (OCL) test parameters: 100 kHz, 1.0 Vrms, 0.0 Adc, +25 °C

2. Full load inductance (FLL) test parameters: 100 kHz, 1.0 Vrms,  $I_{sat}$ , +25 °C

3.  $I_{DC}$ : DC current for an approximate temperature rise of 40 °C without core loss. Derating is necessary for AC currents. PCB layout, trace thickness and width, air-flow, and proximity of other heat generating components will affect the temperature rise. It is recommended that the temperature of the part not exceed +125 °C under worst case operating conditions verified in the end application.

4.  $I_{sat}$ : Peak current for approximately 30% maximum rolloff @ +25 °C

5. Part number definition: SDCLA1V4018-xxx-R

SDCLA1V4018 = Product code and size

xxx= Inductance value in  $\mu$ H, R=decimal point, If no R is present last digit indicates number of zeros

-R suffix = RoHS compliant

6. Absolute maximum voltage 20 V DC Buck

**Dimensions-mm**

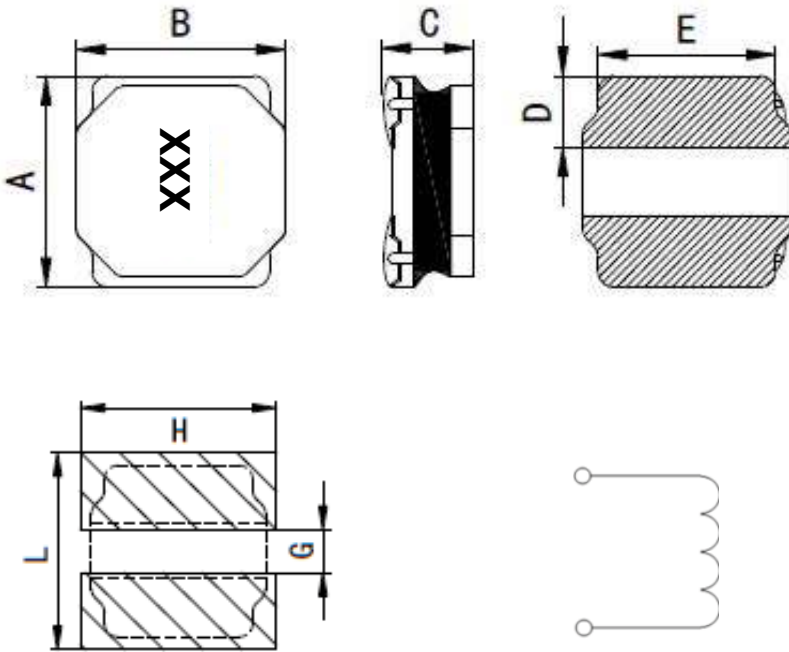

Recommended PCB Layout

Schematic

<b>Dimension</b>	<b>SDCLA1V4018-xxx-R</b>
A	4.0 ± 0.2
B	4.0 ± 0.2
C	1.6 ± 0.2
D	1.1 ± 0.2
E	3.5 ± 0.3
G	1.5
H	4.5
L	4.5

Part marking: xxx= inductance value in uH, R= decimal point. If no R is present then last character equals number of zeros  
 All soldering surfaces to be coplanar within 0.1 millimeters  
 PCB layout is referred to standard IPC-7351B  
 PCB layout reference only  
 Recommend solder paste thickness at 0.12 mm and above  
 Traces or vias underneath the inductor is not recommended

**Packaging information- mm**

**SDCLA1V4018**

Supplied in tape and reel packaging, 3500 parts per 13" diameter reel (EIA-481 compliant)

Drawing not to scale

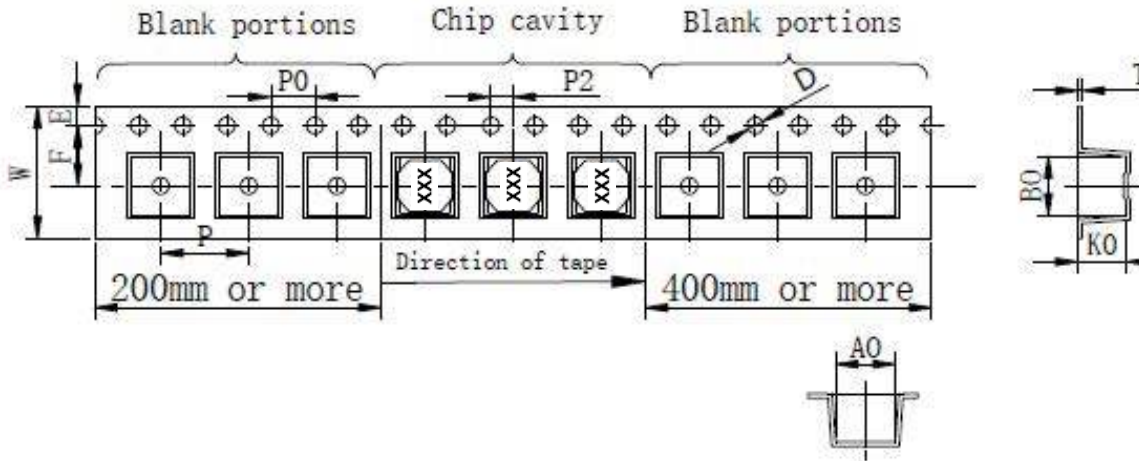

Dimension	Value
W	12.0 ± 0.3
F	5.5 ± 0.1
E	1.75 ± 0.1
P0	4.0 ± 0.1
P	8.0 ± 0.1
P2	2.0 ± 0.1
D	1.5 ± 0.1
A0	4.4 ± 0.1
B0	4.4 ± 0.1
K0	2.0 ± 0.1
T	0.35 ± 0.1

Inductance and temperature rise vs current  
SDCLA1V4018

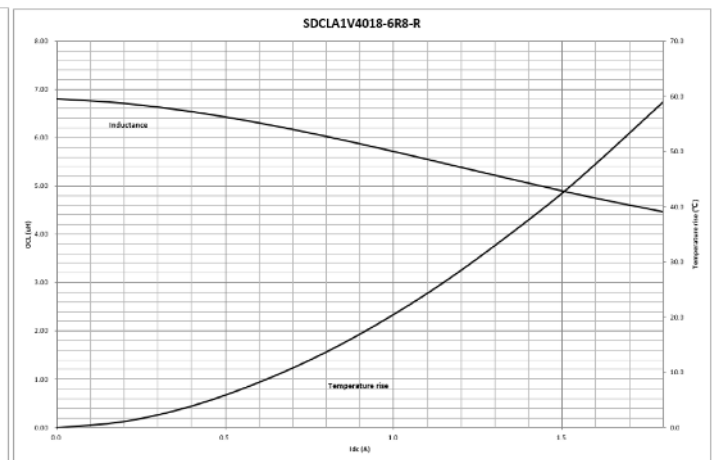
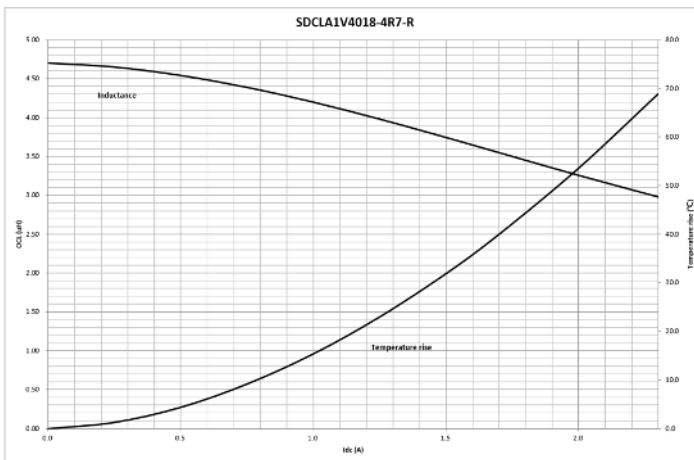
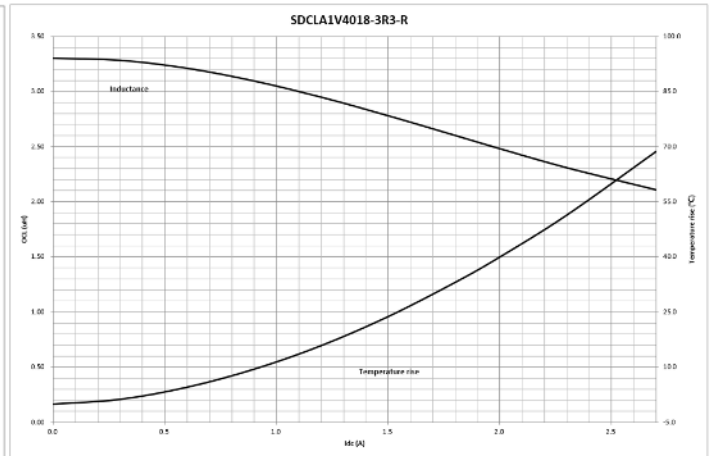
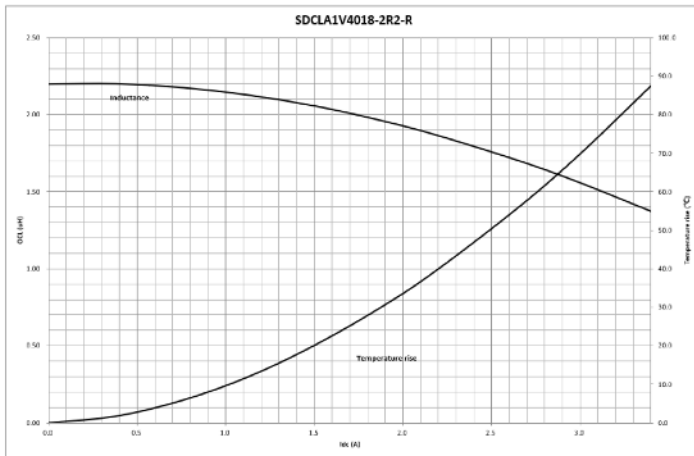
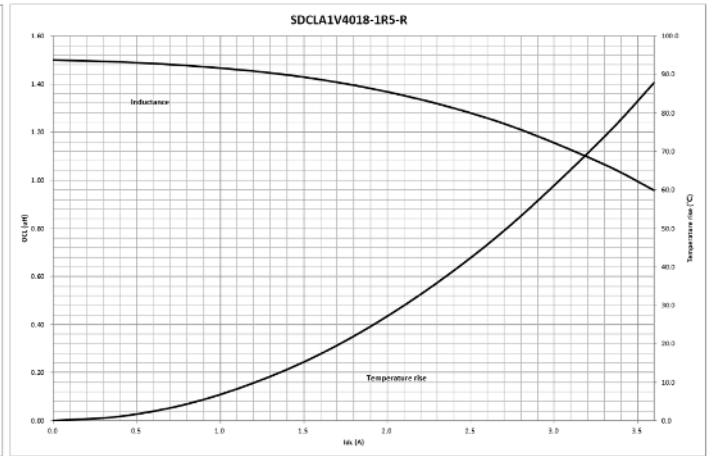
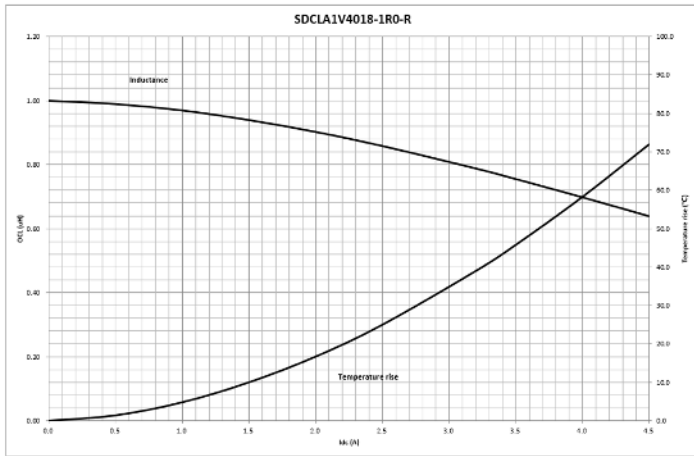

**Inductance and temperature rise vs current**

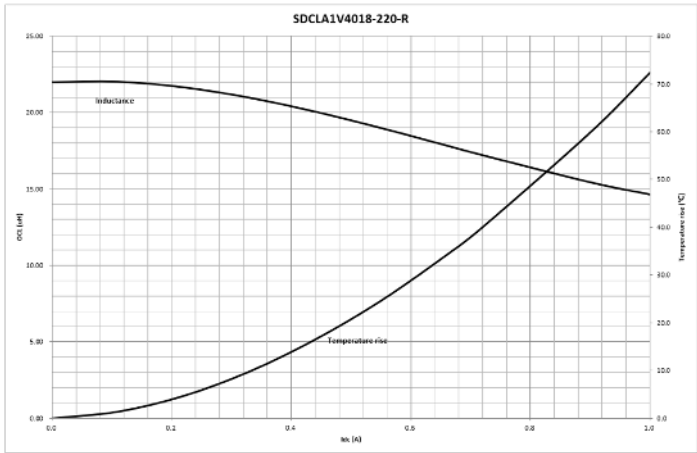
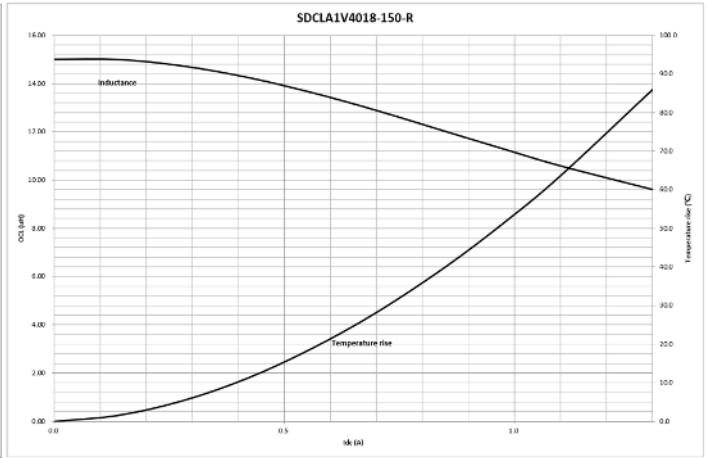
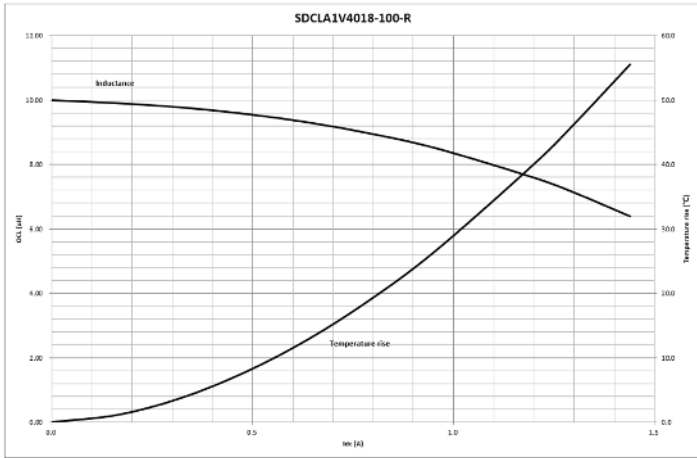

Inductance and impedance vs. frequency curve

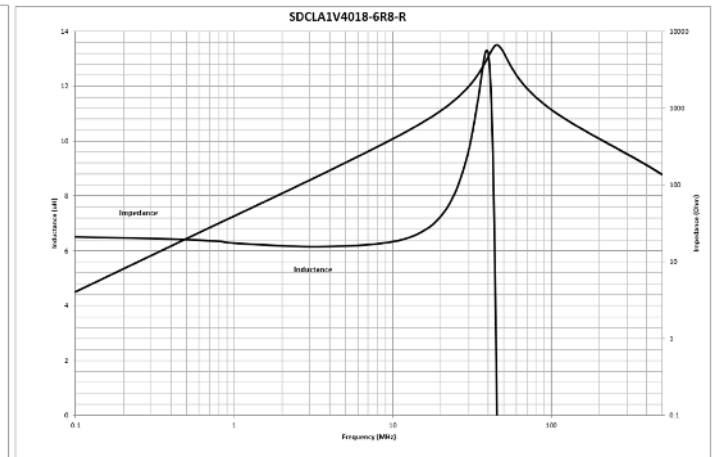
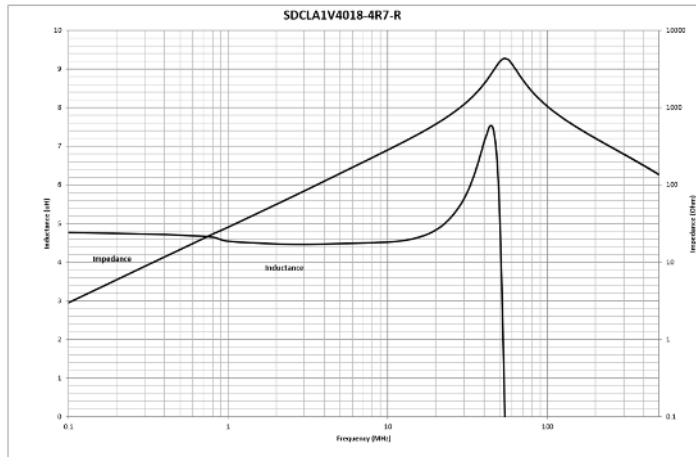
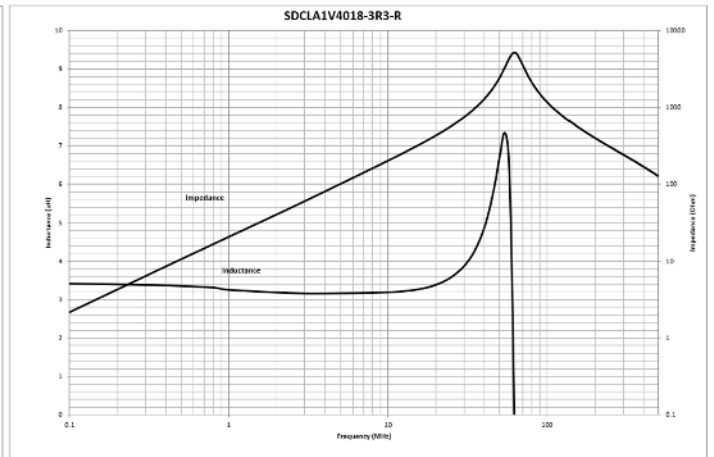
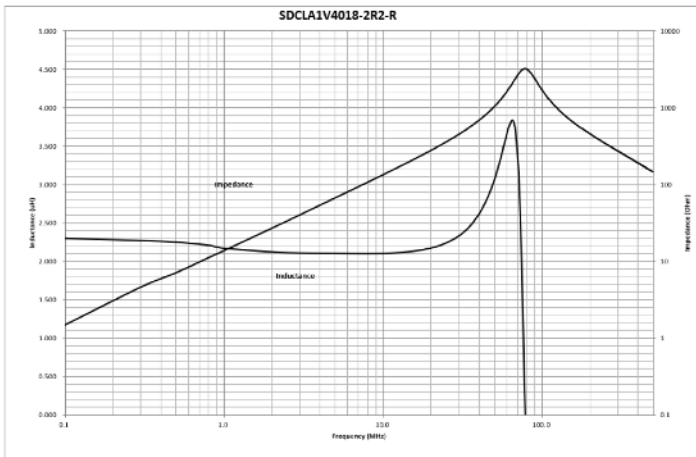
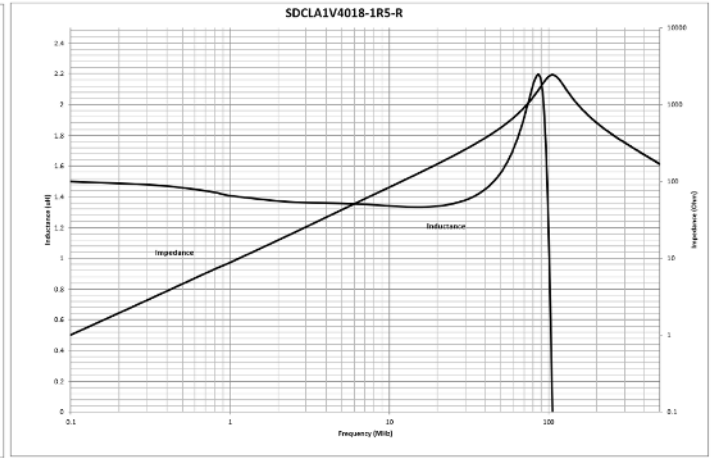
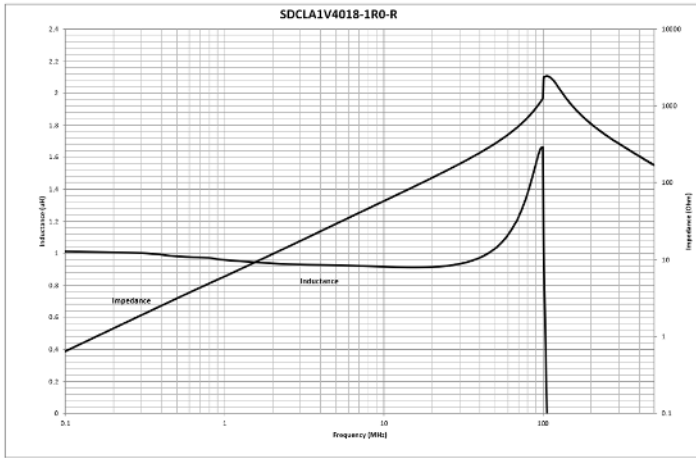

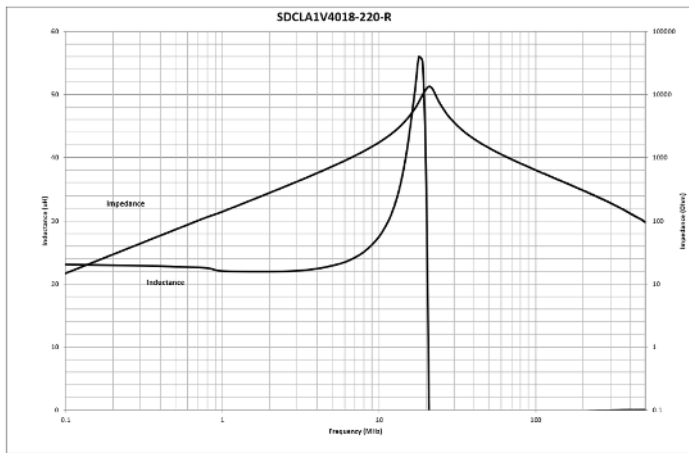
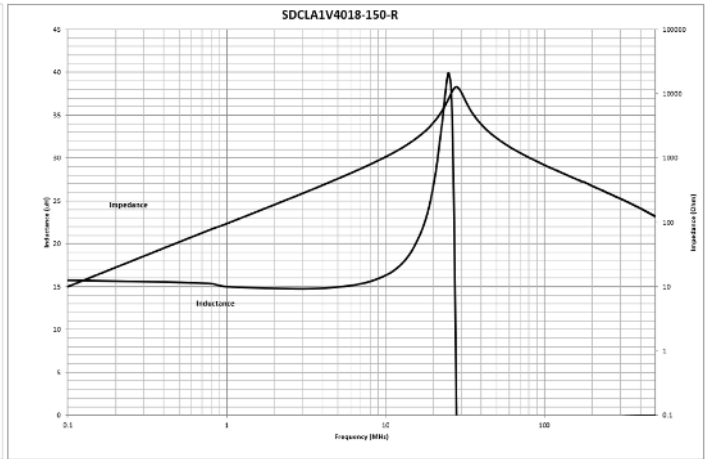
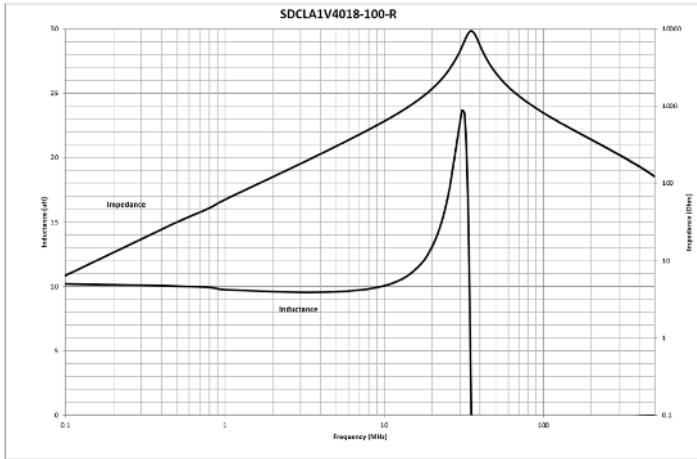



**Solder reflow profile**

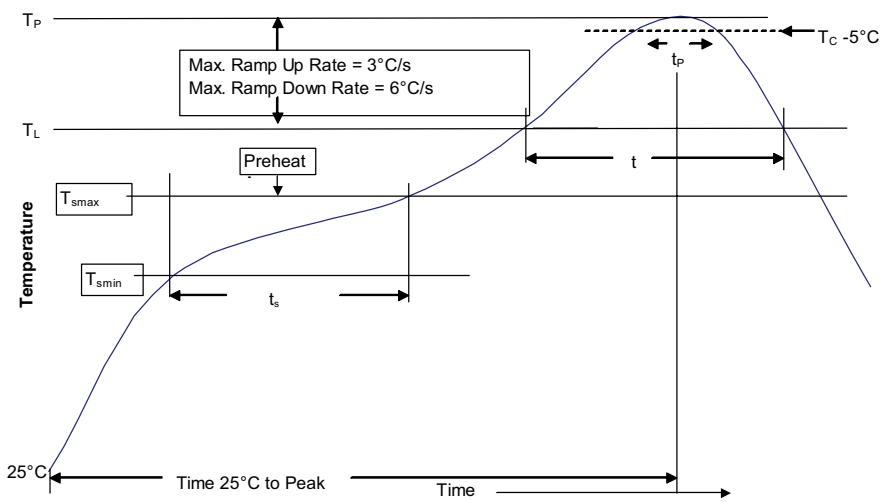

**Table 1 - Standard SnPb solder (T<sub>C</sub>)**

Package thickness	Volume mm <sup>3</sup> <350	Volume mm <sup>3</sup> ≥350
<2.5 mm	235 °C	220 °C
≥2.5 mm	220 °C	220 °C

**Table 2 - Lead (Pb) free solder (T<sub>C</sub>)**

Package thickness	Volume mm <sup>3</sup> <350	Volume mm <sup>3</sup> 350 - 2000	Volume mm <sup>3</sup> >2000
<1.6 mm	260 °C	260 °C	260 °C
1.6 – 2.5 mm	260 °C	250 °C	245 °C
>2.5 mm	250 °C	245 °C	245 °C

**Reference J-STD-020**

Profile feature	Standard SnPb solder	Lead (Pb) free solder
Preheat and soak		
• Temperature min. (T <sub>smin</sub> )	100 °C	150 °C
• Temperature max. (T <sub>smax</sub> )	150 °C	200 °C
• Time (T <sub>smin</sub> to T <sub>smax</sub> ) (t <sub>s</sub> )	60-120 seconds	60-120 seconds
Ramp up rate T <sub>L</sub> to T <sub>p</sub>	3 °C/ second max.	3 °C/ second max.
Liquidous temperature (T <sub>L</sub> )	183 °C	217 °C
Time (t <sub>L</sub> ) maintained above T <sub>L</sub>	60-150 seconds	60-150 seconds
Peak package body temperature (T <sub>p</sub> )*	Table 1	Table 2
Time (t <sub>p</sub> )* within 5 °C of the specified classification temperature (T <sub>C</sub> )	20 seconds*	30 seconds*
Ramp-down rate (T <sub>p</sub> to T <sub>L</sub> )	6 °C/ second max.	6 °C/ second max.
Time 25 °C to peak temperature	6 minutes max.	8 minutes max.

\* Tolerance for peak profile temperature (T<sub>p</sub>) is defined as a supplier minimum and a user maximum.

Life Support Policy: Eaton does not authorize the use of any of its products for use in life support devices or systems without the express written approval of an officer of the Company. Life support systems are devices which support or sustain life, and whose failure to perform, when properly used in accordance with instructions for use provided in the labeling, can be reasonably expected to result in significant injury to the user.

Eaton reserves the right, without notice, to change design or construction of any products and to discontinue or limit distribution of any products. Eaton also reserves the right to change or update, without notice, any technical information contained in this bulletin.

**Eaton**  
**Electronics Division**  
1000 Eaton Boulevard  
Cleveland, OH 44122  
United States  
Eaton.com/electronics

© 2022 Eaton  
All Rights Reserved  
Printed in USA  
Publication No. ELX1098  
September 2022

Eaton is a registered trademark.  
All other trademarks are property of their respective owners.

Follow us on social media to get the latest product and support information.

