

Click to
ORDER
samples

AM250ST-NZ



Enclosed

The AM250ST-NZ is a 250W DC/DC converter that offers greater cost effectiveness due to material normalization and production automation also leading to improved reliability and performance. Offering a wide input voltage range of 43-160VDC and an output voltage are 5-54V, this series will offer many benefits to your new system design. This new series offers great operating temperatures, from -40°C to 100°C. It also features an isolation of 3000VAC for improved reliability and system safety. Furthermore, a high MTBF of 250,000h, output short circuit protection (OSCP), over temperature protection (OTP), output over-voltage protection (OVP), output over-current protection (OCP), input undervoltage protection (UVLO), input reverse polarity protection come standard with the series. The AM250ST-NZ is suitable for street lighting controls, grid power, LED, instrumentation, industrial controls, communication and civil applications.

Features



- Wide Input Range: 43VDC – 160VDC
- Operating Temp: -40 °C to +100 °C
- Low ripple & noise, up to 200mV(p-p) max
- Efficiency up to 89%
- Output short circuit, over temperature, over voltage, over current, input undervoltage, input reverse polarity protection

Summary

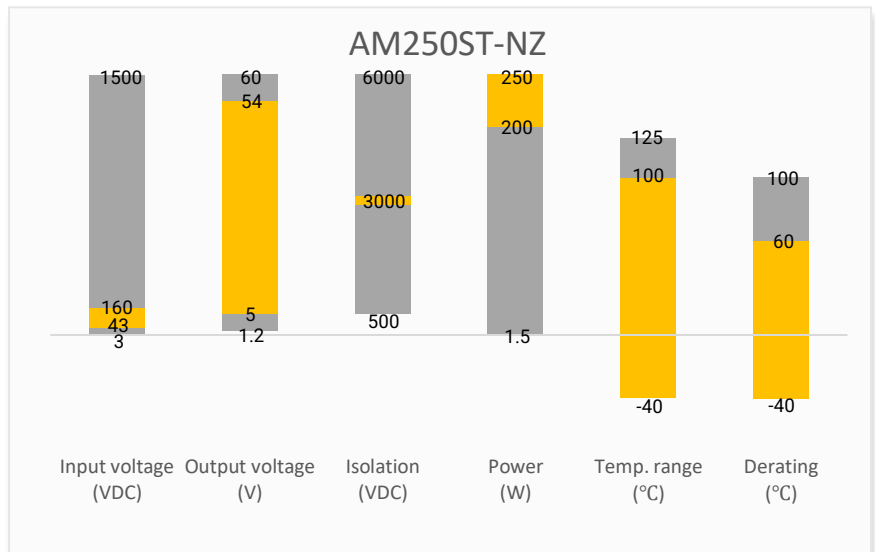

Training



Applications



Product Training Video
(click to open)

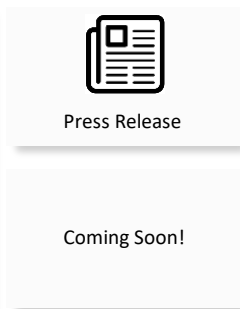

Application Notes



Power Grid



Industrial



Telecom



Instrumentation

Models & Specifications

Single Output								
Model	Input Voltage (VDC)		Output Voltage (VDC)	Input Current Max (mA)		Output Current Max (A)	Maximum Capacitive Load (μF)	Efficiency (%) Full Load
	110	(43 ~ 160)		No Load	Full Load			
AM250ST-11005SA30NZ	110	(43 ~ 160)	5	80	2643	40	22000	87
AM250ST-11012SA30NZ	110	(43 ~ 66) (66 ~ 160)	12	80	2643	16.67 20.84	10000	89
AM250ST-11015SA30NZ	110	(43 ~ 66) (66 ~ 160)	15	80	2643	13.33 16.67	6800	89
AM250ST-11024SA30NZ	110	(43 ~ 66) (66 ~ 160)	24	80	2643	8.33 10.42	4000	89
AM250ST-11048SA30NZ	110	(43 ~ 66) (66 ~ 160)	48	80	2643	4.16 5.2	680	89
AM250ST-11054SA30NZ	110	(43 ~ 66) (66 ~ 160)	54	80	2643	3.7 4.63	680	89

Input Specification				
Parameters	Conditions	Typical	Maximum	Units
Voltage range	See models table			VDC
Filter	Pi filter			
Absolute maximum rating	1 sec. max		185	VDC
Reflected ripple current	Nominal input voltage	80		mA pk-pk
Inrush current		15	30	A
Start-up voltage			43	VDC
Under voltage protection		37		VDC
Start-up time		40	100	mS
Ctrl *	Module ON	Ctrl pin open or pulled high(4.5~12VDC)		
	Module OFF	Ctrl pin pulled low to GND(0~1.2VDC)		
	Input current when OFF	2	10	mA

* The Ctrl pin voltage is referenced to input GND.

Isolation Specification				
Parameters	Conditions	Typical	Maximum	Units
Tested I/O voltage	60 sec, leakage current of 5mA max	>3000		VAC
Tested I/O to case voltage	60 sec, leakage current of 5mA max	>1500		VAC
Resistance	Resistance at 500VDC	≥100		MΩ
Capacitance	I/O capacitance at 100KHz/0.1V	6000		pF
	Input to case capacitance at 100KHz/0.1V, 15V/24V output	7000		pF
	Input to case capacitance at 100KHz/0.1V, Others	6000		pF
	Output to case capacitance at 100KHz/0.1V	4000		pF

Output Specification				
Parameters	Conditions	Typical	Maximum	Units
Voltage accuracy		± 1	± 3	%
Line regulation	Full load	± 0.2	± 0.5	%
Load regulation	0 ~ 100% load, 5V output		± 1.5	%
	0 ~ 100% load, Others		± 0.5	%
Over voltage protection		≥110	160	% Vout
Over current protection		≥110	150	% Iout
Short circuit protection	Continuous, Auto recovery			
Temperature coefficient	Full load		± 0.03	%/°C
Ripple & Noise*	20MHz bandwidth, full load	120	200	mV pk-pk
Transient recovery time	25% load step change	200	500	µS
Transient response deviation	25% load step change	±3	±5	%
Voltage adjustment		± 10		% Vout

* Ripple and Noise are measured at 20MHz bandwidth by using a 0.1µF (M/C) and 220µF (E/C) parallel capacitor and typical input with full load

General Specifications				
Parameters	Conditions	Typical	Maximum	Units
Switching frequency	PWM mode	260		KHz
Operating temperature	See derating graph	-40 to +100		°C
Storage temperature		-55 to +125		°C
Shock and Vibration	IEC/EN61373 – Category 1, Grade B			
Cooling	Free air convection (20 LFM) or forced air convection			
Humidity	Non-condensing		95	% RH
Case material	Aluminum alloy			
Weight		418		g
Dimensions (L x W x H)	6.50 x 3.07 x 1.63 inches, 165.00 x 78.00 x 41.50mm			
MTBF	> 250 000 hrs (MIL-HDBK -217F, t=+25°C) / Full Load			

Safety Specifications		
Parameters		
Standards	Designed to meet EN 50155	
	EMC - Conducted and radiated emission	CISPR32/EN55032, CLASS A EN50121-3-2/EN55016-2-1
	Electrostatic Discharge Immunity	IEC 61000-4-2, Contact ±6KV/Air ±8KV, Criteria A EN50121-3-2, Contact ±6KV/Air ±8KV, Criteria A
	RF, Electromagnetic Field Immunity	IEC 61000-4-3, 20V/m, Criteria A EN50121-3-2, 20V/m, Criteria A
	Electrical Fast Transient/Burst Immunity	IEC 61000-4-4, ±2KV, Criteria A EN50121-3-2, ±2KV 5/50ns 5kHz, Criteria A
	Surge Immunity	IEC 61000-4-5, L-L ±1KV/L-G ±2KV, Criteria A EN50121-3-2, L-L ±1KV/L-G ±2KV, Criteria A
	RF, Conducted Disturbance Immunity	IEC 61000-4-6, 10Vr.m.s, Criteria A EN50121-3-2, 0.15MHz-80MHz, 10Vr.m.s, Criteria A

Derating



AM250ST-11005SA30NZ Thermal Curves

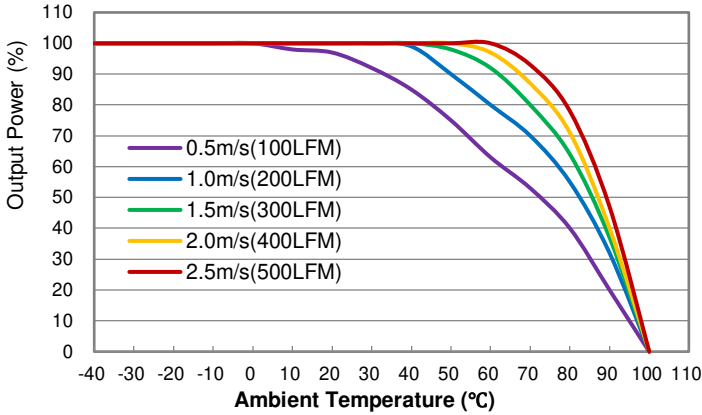

AM250ST-11012SA30NZ Thermal Curves

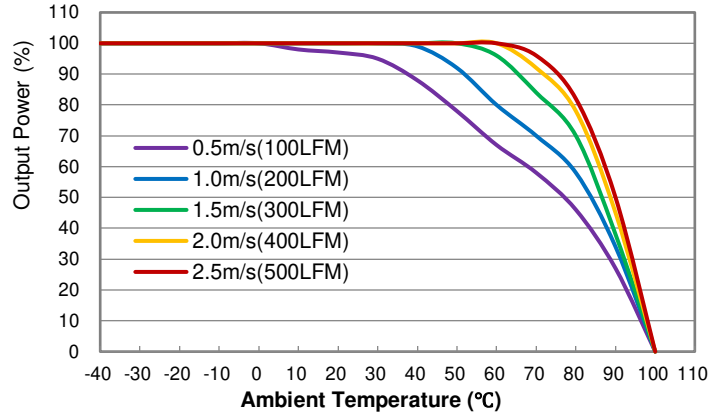

AM250ST-11015SA30NZ Thermal Curves

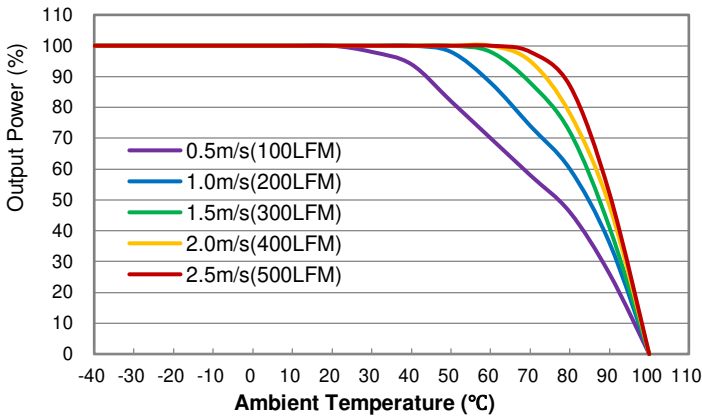

AM250ST-11024SA30NZ Thermal Curves

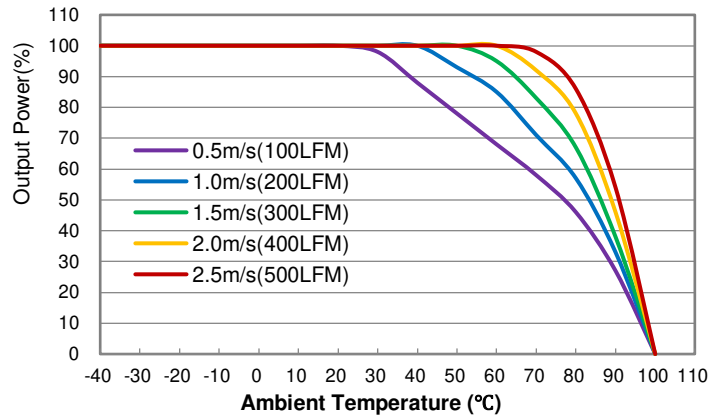

AM250ST-11048SA30NZ Thermal Curves

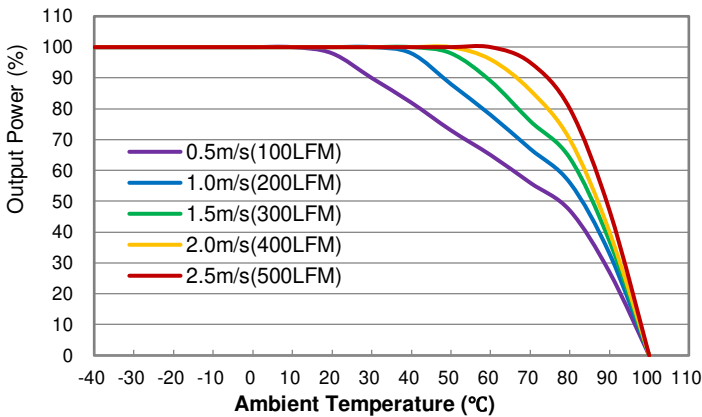

AM250ST-11054SA30NZ Thermal Curves

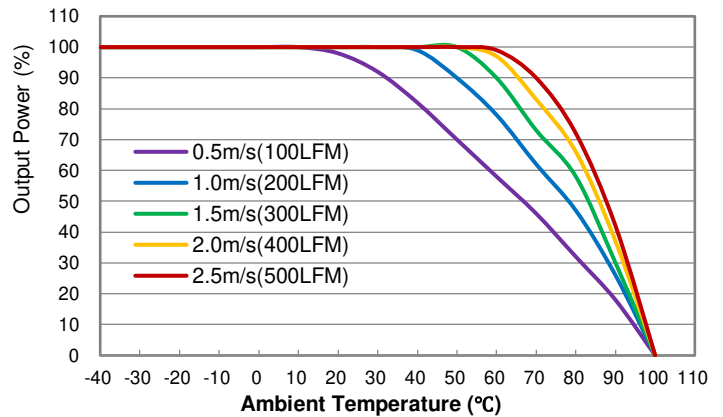

Note: Temperature derating curves are typical test values (Vin=110V)

Typical Application Circuit

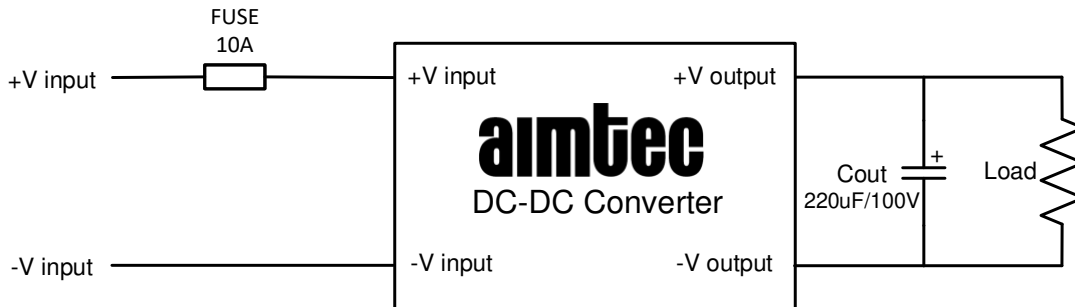

Trimming

Output voltage can be externally trimmed by utilizing the methods as shown below

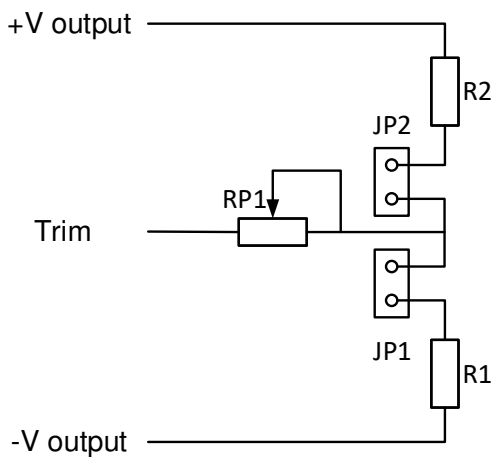

Output voltage can at $\pm 10\%$ change to regulate the adjustable resistor RP1.

Output voltage up : Short circuit JP1, rotate RP1 clockwise to increase the output voltage, anticlockwise to reduce the output voltage.

Output voltage down : Short circuit JP2, rotate RP1 clockwise to reduce the output voltage, anticlockwise to increase the output voltage.

Note:

Adjustable Voltage range will be slightly greater than $\pm 10\%$ Voutput. In order to ensure reliable use of the product, please adjust the output voltage range within $\pm 10\%$ Voutput .

The products do not support parallel connection of their output.

Dimensions

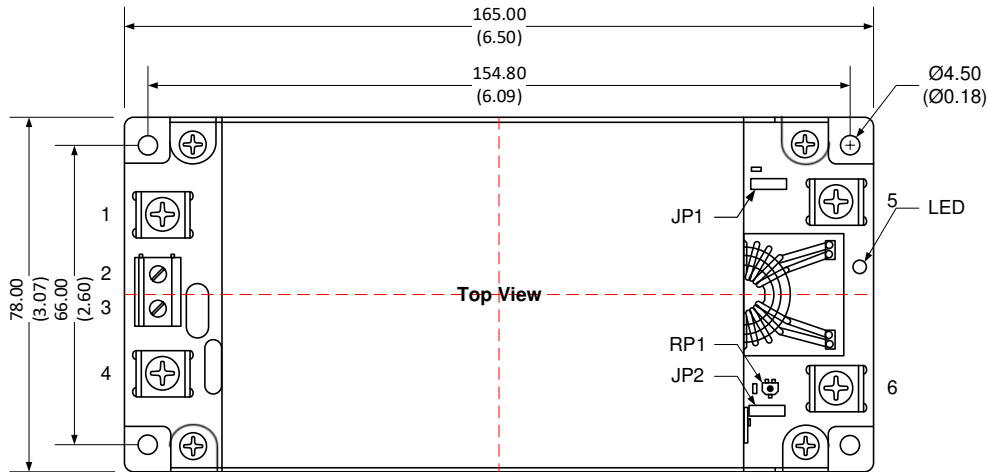

Pin Output Specifications	
Pin	Positive output
1	-V Input
2	Ctrl (ON/OFF)
3	Ctrl (ON/OFF)
4	+V Input
5	-V Output
6	+V Output

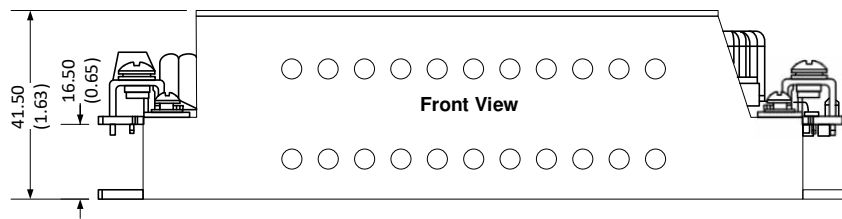

Notes:
 All dimensions are typical in millimeters (inches)
 Wire range : 22-12AWG
 Tightening torque : CN1 M2.5 Max 0.4 N.m
 CN2 M5 Max 1.9 N.m
 Stand-off tolerance : ±1.00 (±0.04)

NOTE: 1. Datasheets are updated as needed and as such, specifications are subject to change without notice. Once printed or downloaded, datasheets are no longer controlled by Aimtec; refer to www.aimtec.com for the most current product specifications. 2. Product labels shown, including safety agency certifications on labels, may vary based on the date manufactured. 3. Mechanical drawings and specifications are for reference only. 4. All specifications are measured at an ambient temperature of 25°C, humidity<75%, nominal input voltage and at rated output load unless otherwise specified. 5. Aimtec may not have conducted destructive testing or chemical analysis on all internal components and chemicals at the time of publishing this document. CAS numbers and other limited information are considered proprietary and may not be available for release. 6. This product is not designed for use in critical life support systems, equipment used in hazardous environments, nuclear control systems or other such applications which necessitate specific safety and regulatory standards other than the ones listed in this datasheet. 7. Warranty is in accordance with Aimtec's standard Terms of Sale available at www.aimtec.com.