

320630 ✓ ACTIVE



## PIDG

TE Internal #: 320630

Ring Terminals & Spade Terminals, Ring Tongue, 16 – 14 AWG

Wire Size, 1.25 – 2 mm<sup>2</sup> Wire Size, 2050 – 5180 CMA Wire Size, Stud

Size #10, PIDG

[View on TE.com >](#)

Terminals & Splices > Ring Terminals & Spade Terminals > PIDG Ring Tongue Terminals

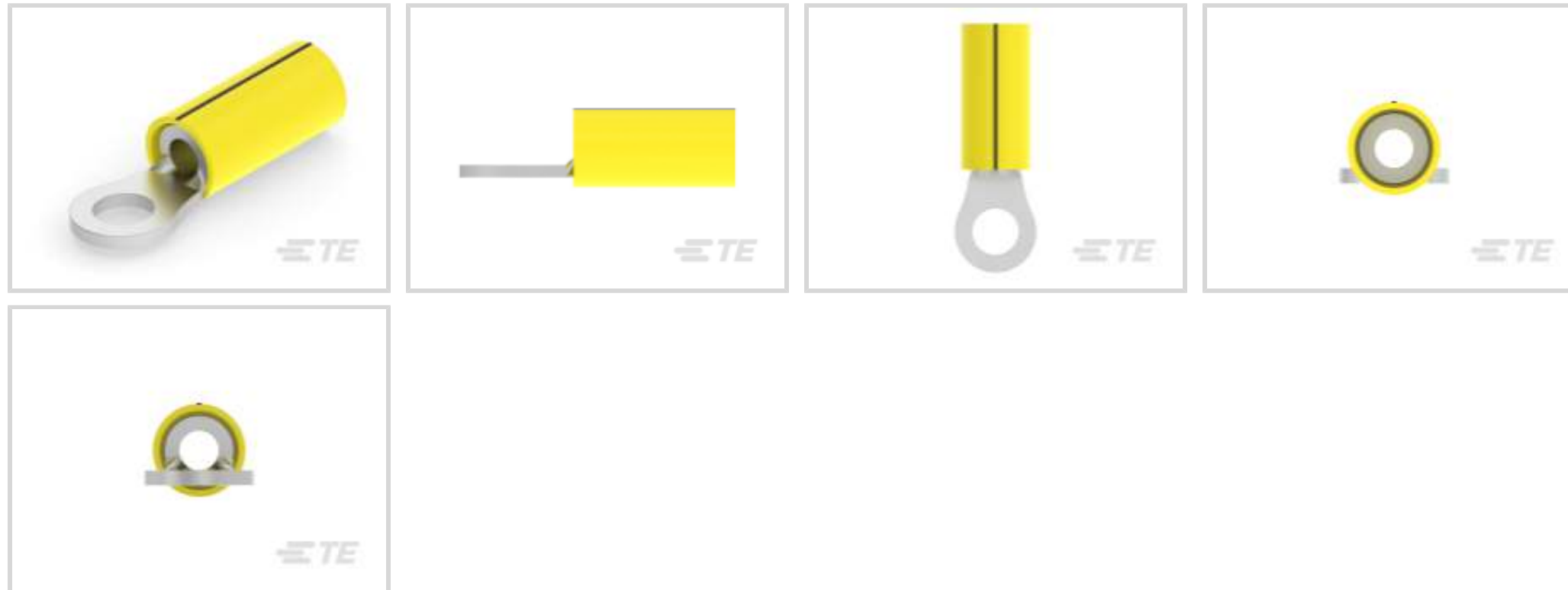

Ring & Spade Terminal Type: **Ring Tongue**

Wire Size: **2050 – 5180 CMA**

Stud Size: **#10**

[All PIDG Ring Tongue Terminals \(421\)](#)

## Features

### Product Type Features

Terminal Features	Heavy Duty
Stud Size	#10
Sealable	No
Wire Insulation Support Retention Type	Non-Insulation Support

### Configuration Features

Number of Holes	1
-----------------	---

### Electrical Characteristics

Voltage Rating	300 V
----------------	-------

### Body Features

Product Weight	10 g
Stripe Color	Black

### Contact Features

Ring & Spade Terminal Type	Ring Tongue
----------------------------	-------------



Barrel Type	Closed
-------------	--------

Terminal Orientation	Straight
----------------------	----------

Terminal Plating Material	Tin
---------------------------	-----

### Mechanical Attachment

Wire Insulation Support	With
-------------------------	------

### Dimensions

Wire Size	2050 – 5180 CMA
-----------	-----------------

Stud Diameter	4.82 mm[.19 in]
---------------	-----------------

Tongue Thickness	.79 mm[.031 in]
------------------	-----------------

Product Length	26.6 mm[1.046 in]
----------------	-------------------

Compatible Insulation Diameter (Max)	5.84 mm[.23 in]
--------------------------------------	-----------------

Compatible Insulation Diameter Range	3.81 – 5.84 mm[.15 – .23 in]
--------------------------------------	------------------------------

### Usage Conditions

Insulation Option	Partially Insulated
-------------------	---------------------

Operating Temperature Range	105 °C[221 °F]
-----------------------------	----------------

### Operation/Application

Compatible With Wire Base Material	Copper
------------------------------------	--------

Compatible With Wire Plating Material	Tin
---------------------------------------	-----

### Industry Standards

Government Qualified Terminal	No
-------------------------------	----

### Packaging Features

Packaging Quantity	500
--------------------	-----

Packaging Method	Loose Piece
------------------	-------------

### Other

Terminals & Splices Comment	Heavy Duty for extra mechanical strength
-----------------------------	--

### Product Compliance

[For compliance documentation, visit the product page on TE.com>](#)

EU RoHS Directive 2011/65/EU	Compliant
------------------------------	-----------

EU ELV Directive 2000/53/EC	Compliant
-----------------------------	-----------

China RoHS 2 Directive MIIT Order No 32, 2016	No Restricted Materials Above Threshold
---	---

EU REACH Regulation (EC) No. 1907/2006	
--	--



Current ECHA Candidate List: JUNE 2023 (235)  
 Candidate List Declared Against: JUNE 2023 (235)  
 Does not contain REACH SVHC

Halogen Content

Low Halogen - Br, Cl, F, I < 900 ppm per homogenous material. Also BFR/CFR/PVC Free

Solder Process Capability

Not applicable for solder process capability

Product Compliance Disclaimer

This information is provided based on reasonable inquiry of our suppliers and represents our current actual knowledge based on the information they provided. This information is subject to change. The part numbers that TE has identified as EU RoHS compliant have a maximum concentration of 0.1% by weight in homogenous materials for lead, hexavalent chromium, mercury, PBB, PBDE, DBP, BBP, DEHP, DIBP, and 0.01% for cadmium, or qualify for an exemption to these limits as defined in the Annexes of Directive 2011/65/EU (RoHS2). Finished electrical and electronic equipment products will be CE marked as required by Directive 2011/65/EU. Components may not be CE marked. Additionally, the part numbers that TE has identified as EU ELV compliant have a maximum concentration of 0.1% by weight in homogenous materials for lead, hexavalent chromium, and mercury, and 0.01% for cadmium, or qualify for an exemption to these limits as defined in the Annexes of Directive 2000/53/EC (ELV). Regarding the REACH Regulation, the information TE provides on SVHC in articles for this part number is based on the latest European Chemicals Agency (ECHA) 'Guidance on requirements for substances in articles' posted at this URL: <https://echa.europa.eu/guidance-documents/guidance-on-reach>

## Compatible Parts



TE Part # 58433-3  
PRO CR ASSY, RBY IS9252



TE Part # 59239-4  
HHHT PIDG PG 12-10 ASSY



TE Part # 58423-1  
DIE, RBY IS9252



TE Part # 59824-1  
TETRA-CRIMP PIDG PG FASTON 22-10 ASSY



TE Part # 539691-2  
ERGO DIE R.B.Y



TE Part # 2063030-1  
SDE DIESET, RBY, UL



TE Part # 47808-6  
DIES PIDG 12-10 DIE SET

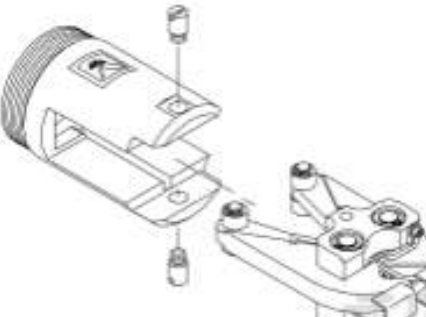

TE Part # 679300-1  
1210 PIDG CRIMP HEAD

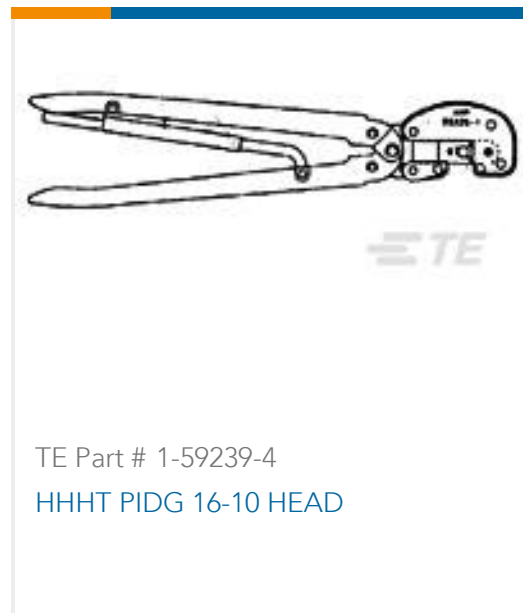

Also in the Series | PIDG

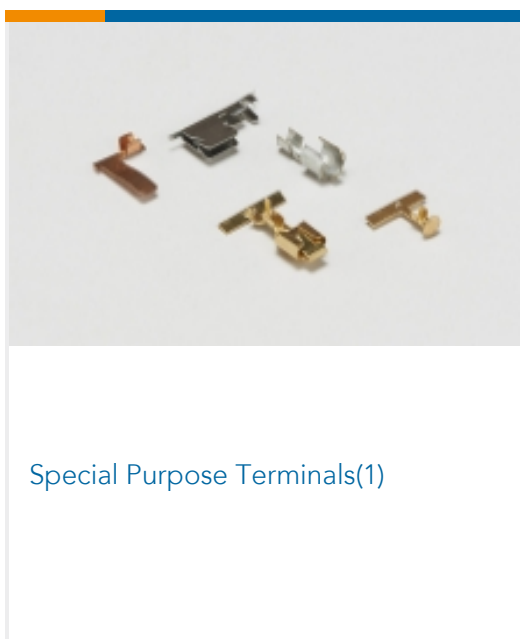
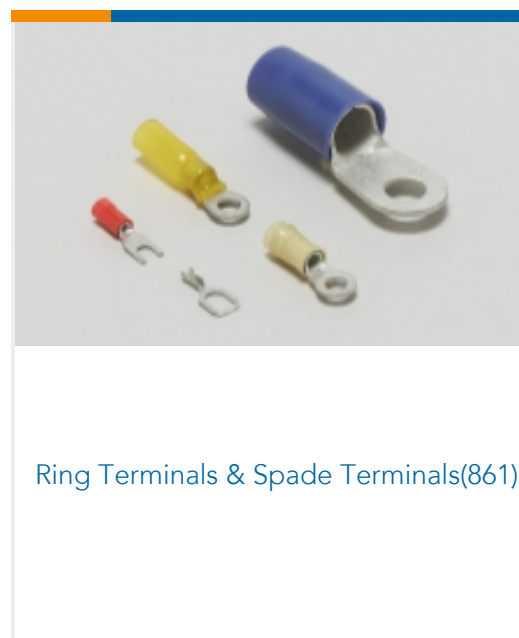
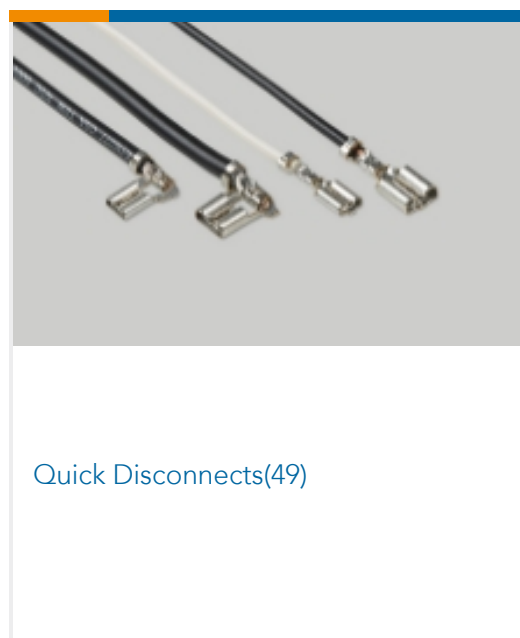
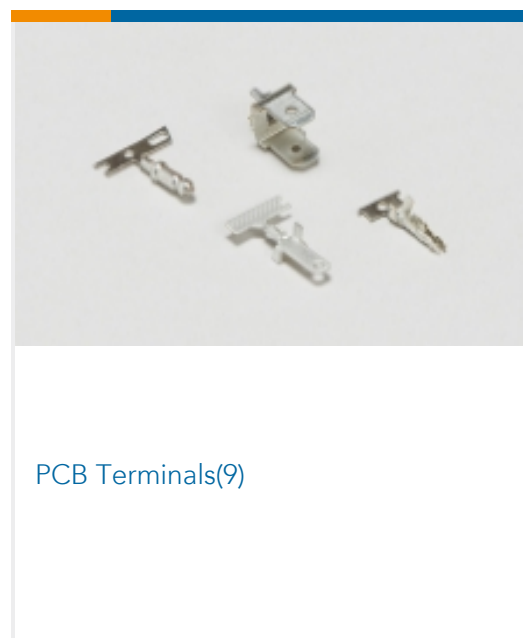
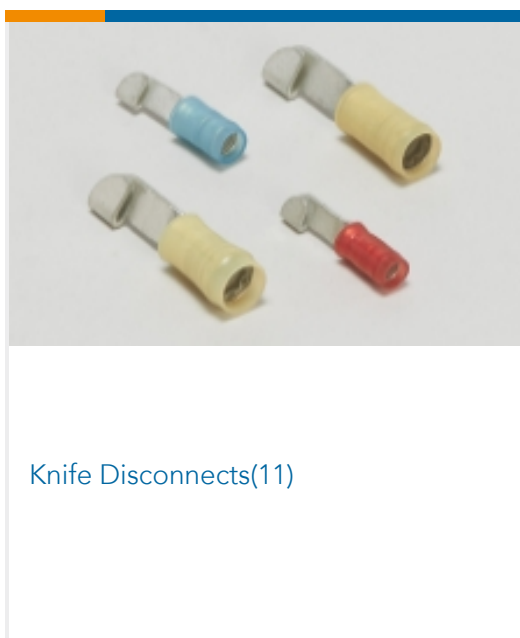
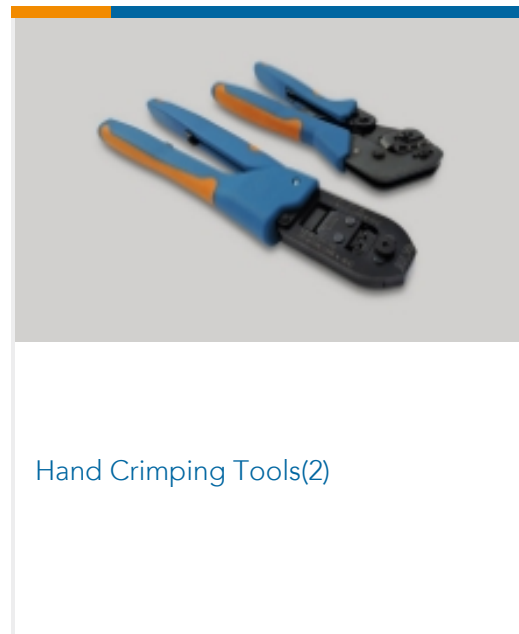
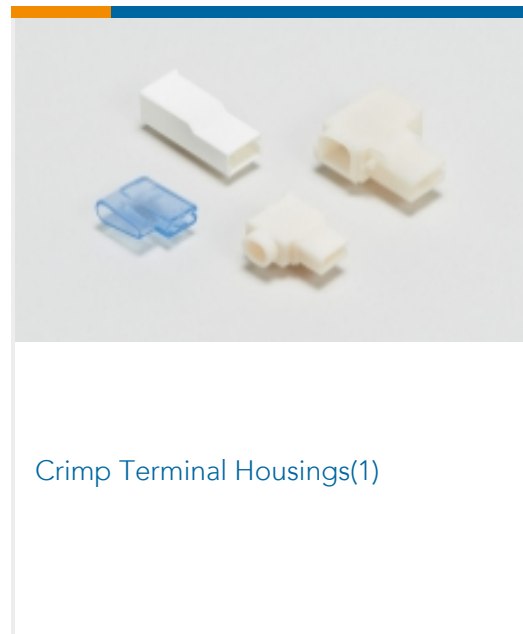
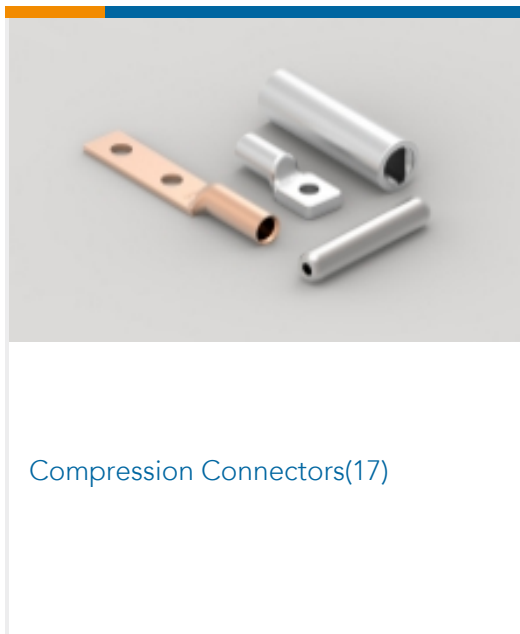

Customers Also Bought



TE Part #647401-6  
06P SL156 HSG W/RAMP,LRG OPEN



TE Part #6609017-5  
3EC1=F7282 S0



TE Part #5-1879071-1  
THS50 820R 5%



TE Part #104483-4  
26 SHORT PT RCPT HSG DR .100CL



TE Part #6-102398-8  
40 AMPMODU MT ASSY DR .100CL

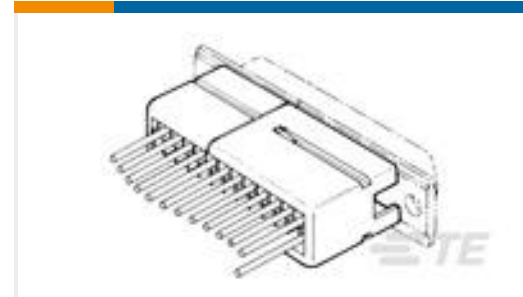

TE Part #745530-3  
25 POS COVER KIT



TE Part #5-102393-8  
20 AMPMODU MT ASSY DR.100CL SN

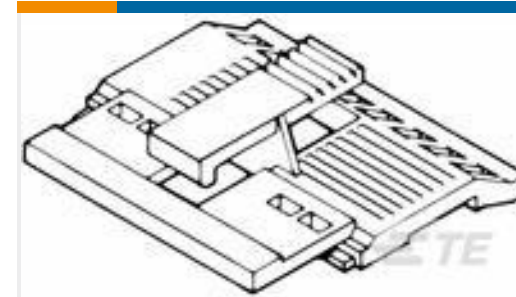

TE Part #102681-3  
16 AMPMODU MT COVER DR .100CL

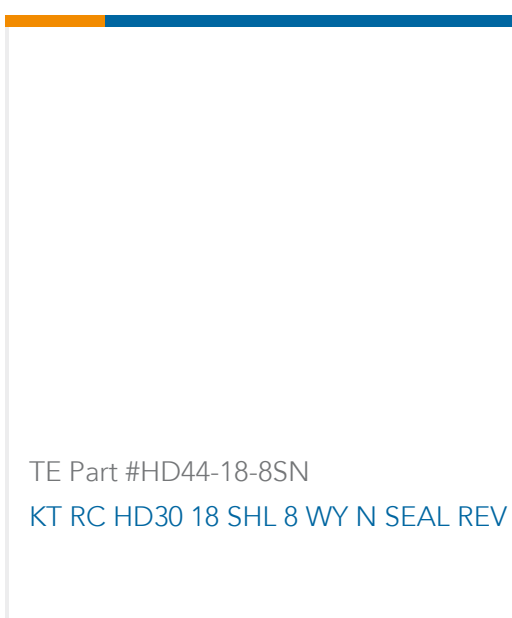

TE Part #HD44-18-8SN  
KT RC HD30 18 SHL 8 WY N SEAL REV

## Documents

### Product Drawings

[TERMINAL,PIDG R 16-14HD 10](#)

English

### CAD Files

[3D PDF](#)

3D

Customer View Model

[ENG\\_CVM\\_CVM\\_320630\\_P.2d\\_dxf.zip](#)

English

Customer View Model

[ENG\\_CVM\\_CVM\\_320630\\_P.3d\\_igs.zip](#)

English

Customer View Model

[ENG\\_CVM\\_CVM\\_320630\\_P.3d\\_stp.zip](#)

English

By downloading the CAD file I accept and agree to the [Terms and Conditions](#) of use.

## Product Specifications



### Application Specification

English

---

### Product Environmental Compliance

#### TE Material Declaration

English

---

### Agency Approvals

#### UL Report

English

#### UL Report

English