

## BWCT Series



Due to accurate wire winding technology, these chip inductors are designed for filtering, impedance matching, resonance and choke circuits for RF designer. Both standard series custom designs are available.

### Features

- RoHS compliant.
- Ceramic body and wire wound construction provide highest SRFs
- Exceptional Q values even at high frequencies
- Highest possible SRFs as well as excellent Q values
- The non-magnetic coil form assures utmost thermal stability, predictability and batch consistency

### Applications

- RF products for cellular phone
- GPS receiver
- Base Station
- Repeater
- Wireless LAN/ mouse/ keyboard/ earphone
- Remote control
- Security system and other RF modules

### Product Identification

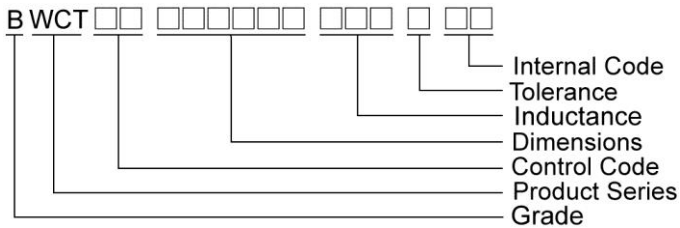

### Shape and Dimensions/ Recommended Pattern

**BWCT00160906**

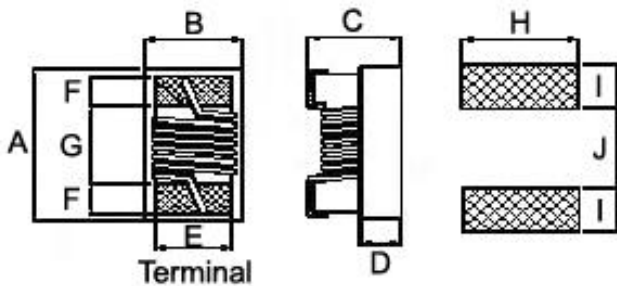

**BWCT00231711**

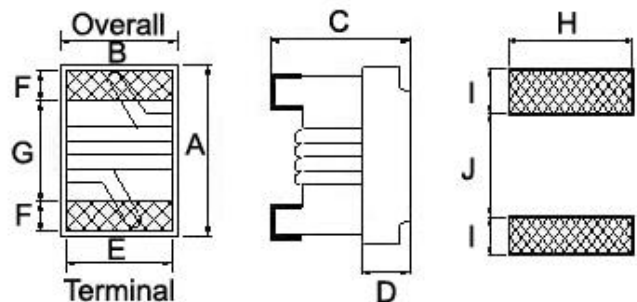

Dimensions

		A	B	C	D	E	F	G	H	I	J
<b>BWCT00160906</b>	mm	1.6 <sup>+0.2</sup> <sub>-0.1</sub>	0.9±0.1	0.55±0.05	0.25	0.76	0.30	0.92	1.02	0.64	0.64
		<b>A Max</b>	<b>B Max</b>	<b>C Max</b>	<b>D</b>	<b>E</b>	<b>F</b>	<b>G</b>	<b>H</b>	<b>I</b>	<b>J</b>
<b>BWCT00231711</b>	inch	0.093	0.068	0.039	0.020	0.050	0.020	0.040	0.070	0.040	0.030
	mm	2.35	1.73	1.10	0.51	1.27	0.51	1.02	1.78	1.02	0.76

## SMD Wire Wound Ceramic Chip Inductors – BWCT Series

### Electrical Characteristics

Part Number	Inductance (nH)	Tolerance (±%)	Test Frequency (MHz)	Q Min	Test Frequency (MHz)	SRF (MHz) Min	RDC (Ω) Max	Irms (mA) Max
BWCT001609061N0□00	1.0	10	250	13	250	16000	0.045	1600
BWCT001609061N2□00	1.2	10	250	12	250	16000	0.105	1100
BWCT001609062N0□00	2.0	5,10	250	21	250	12000	0.034	1900
BWCT001609062N2□00	2.2	5,10	250	21	250	10700	0.046	1600
BWCT001609062N3□00	2.3	5,10	250	25	250	11000	0.046	1600
BWCT001609062N5□00	2.5	5,10	250	20	250	11000	0.060	1300
BWCT001609063N0□00	3	5,10	250	25	250	10700	0.039	1600
BWCT001609063N3□00	3.3	3,5	250	26	250	7000	0.039	1600
BWCT001609063N6□00	3.6	3,5	250	28	250	7000	0.044	1600
BWCT001609063N9□00	3.9	3,5	250	26	250	6300	0.050	1400
BWCT001609064N3□00	4.3	3,5	250	22	250	6300	0.076	1300
BWCT001609064N7□00	4.7	3,5	250	22	250	5600	0.120	960
BWCT001609065N1□00	5.1	3,5	250	24	250	5500	0.050	1400
BWCT001609065N6□00	5.6	3,5	250	27	250	5050	0.058	1300
BWCT001609066N8□00	6.8	3,5	250	24	250	4500	0.080	1200
BWCT001609067N2□00	7.2	3,5	250	29	250	4500	0.047	1500
BWCT001609068N2□00	8.2	3,5	250	27	250	4250	0.075	1300
BWCT001609069N5□00	9.5	3,5	250	27	250	3950	0.092	1100
BWCT0016090610N□00	10	2,5	250	27	250	3950	0.075	1300
BWCT0016090611N□00	11	2,5	250	26	250	4000	0.110	1000
BWCT0016090612N□00	12	2,5	250	28	250	3500	0.130	920
BWCT0016090615N□00	15	2,5	250	26	250	3300	0.145	800
BWCT0016090616N□00	16	2,5	250	26	250	3100	0.175	760
BWCT0016090618N□00	18	2,5	250	26	250	2950	0.200	720
BWCT0016090620N□00	20	2,5	250	28	250	2900	0.175	760
BWCT0016090622N□00	22	2,5	250	28	250	2750	0.220	700
BWCT0016090624N□00	24	2,5	250	29	250	2700	0.240	680
BWCT0016090627N□00	27	2,5	250	27	250	2550	0.270	670
BWCT0016090630N□00	30	2,5	250	27	250	2450	0.330	600
BWCT0016090633N□00	33	2,5	250	27	250	2200	0.330	600
BWCT0016090636N□00	36	2,5	250	28	250	2300	0.335	600
BWCT0016090639N□00	39	2,5	250	28	250	2250	0.400	570
BWCT0016090643N□00	43	2,5	250	27	250	2100	0.440	530
BWCT0016090647N□00	47	2,5	250	27	250	1900	0.540	470
BWCT0016090651N□00	51	2,5	250	26	250	1850	0.570	440
BWCT0016090656N□00	56	2,5	250	26	250	1750	0.700	420

**Note: When ordering, please specify tolerance code. Tolerance : G=±2% , H=±3% , J=±5% , K=±10%**

- Operating temperature range - 40°C ~ 125°C(Including self - temperature rise)
- I rms for a 15°C temperature rise from 25°C ambient with current
- Measure Equipment :
  - L & Q : Agilent E4991A+Agilent HP16197A
  - SRF : Agilent/HP8753D/Agilent E4991A
  - RDC: HP4338B or Chroma 16502
  - I rms : HP4284A+HP42841A/HP4285A+HP42841A

Please be sure to request approval specifications that provide further details of the products. Kindly note that the content of these specifications are subject to change or may be discontinued without prior notice. This product may not be designed/used in medical or high risk applications without Chilisin approval. Please contact our sales department before ordering.

## SMD Wire Wound Ceramic Chip Inductors – BWCT Series

### Electrical Characteristics

Part Number	Inductance (nH)	Tolerance (±%)	Test Frequency (MHz)	Q Min	Test Frequency (MHz)	SRF (MHz) Min	RDC (Ω) Max	Irms (mA) Max	Color
BWCT002317111N8□00	1.8	10	250	55	1500	9400	0.03	800	Black
BWCT002317113N9□00	3.9	10	250	50	1000	6100	0.06	800	Brown
BWCT002317114N7□00	4.7	10 / 5	250	50	1000	5500	0.06	800	Red
BWCT002317115N1□00	5.1	10 / 5	250	50	1000	5500	0.06	800	-
BWCT002317116N8□00	6.8	10 / 5	250	50	1000	5500	0.08	800	Orange
BWCT002317118N2□00	8.2	10 / 5	250	50	1000	4800	0.08	800	Yellow
BWCT0023171110N□00	10	10 / 5 / 2	250	55	750	3300	0.08	800	Green
BWCT0023171112N□00	12	10 / 5 / 2	250	55	750	3800	0.10	800	Blue
BWCT0023171115N□00	15	10 / 5 / 2	250	50	500	2950	0.10	800	Violet
BWCT0023171118N□00	18	10 / 5 / 2	250	50	500	3100	0.13	800	Gray
BWCT0023171122N□00	22	10 / 5 / 2	250	50	500	2900	0.15	800	White
BWCT0023171127N□00	27	10 / 5 / 2	250	50	500	2450	0.23	600	Black
BWCT0023171133N□00	33	10 / 5 / 2	250	55	500	2350	0.28	600	Brown
BWCT0023171139N□00	39	10 / 5 / 2	250	55	500	2200	0.33	600	Red
BWCT0023171147N□00	47	10 / 5 / 2	200	50	500	2000	0.39	600	Orange
BWCT0023171156N□00	56	10 / 5 / 2	200	50	500	1850	0.39	500	Yellow
BWCT0023171168N□00	68	10 / 5 / 2	200	50	500	1500	0.40	500	Green
BWCT0023171182N□00	82	10 / 5 / 2	150	50	500	1500	0.44	500	Blue
BWCT00231711R10□00	100	10 / 5 / 2	150	50	500	1200	0.64	400	Violet
BWCT00231711R12□00	120	10 / 5 / 2	150	40	250	1150	0.68	300	Gray
BWCT00231711R15□00	150	10 / 5 / 2	150	40	250	1050	0.80	300	White
BWCT00231711R18□00	180	10 / 5 / 2	150	40	250	950	0.90	300	Black
BWCT00231711R22□00	220	10 / 5 / 2	150	40	250	900	0.98	300	Brown
BWCT00231711R27□00	270	10 / 5 / 2	150	40	250	850	1.30	300	Red
BWCT00231711R33□00	330	10 / 5 / 2	100	40	250	800	1.45	300	Orange
BWCT00231711R39□00	390	10 / 5 / 2	100	35	250	700	1.60	300	Yellow
BWCT00231711R47□00	470	10 / 5 / 2	50	25	100	600	1.80	300	Green
BWCT00231711R56□00	560	10 / 5 / 2	25	18	50	550	1.90	300	Blue
BWCT00231711R62□00	620	10 / 5 / 2	25	18	50	450	2.00	300	Violet
BWCT00231711R68□00	680	10 / 5 / 2	25	18	50	420	2.10	300	Gray
BWCT00231711R75□00	750	10 / 5 / 2	25	18	50	400	2.20	300	White
BWCT00231711R82□00	820	10 / 5 / 2	25	18	50	400	2.50	300	Black
BWCT00231711R0□00	1000	10 / 5	25	17	50	330	3.10	300	Brown

**Note: When ordering, please specify tolerance code. Tolerance : G=±2% , J=±5% , K=±10%**

- Operating temperature range - 40°C ~ 125°C(Including self - temperature rise)
- Irms for a 15°C temperature rise from 25°C ambient with current
- Measure Equipment :
  - L & Q : Agilent E4991A+Agilent HP16197A
  - SRF : Agilent/HP8753D/Agilent E4991A
  - RDC: HP4338B or Chroma 16502
  - Irms : HP4284A+HP42841A/HP4285A+HP42841A

Please be sure to request approval specifications that provide further details of the products. Kindly note that the content of these specifications are subject to change or may be discontinued without prior notice. This product may not be designed/used in medical or high risk applications without Chilisin approval. Please contact our sales department before ordering.

# SMD Wire Wound Ceramic Chip Inductors – BWCT Series

Test Instruments : Agilent E4991A Material/Impedance Analyzer

**BWCT00160906**

Typical **L** vs. **F** Frequency

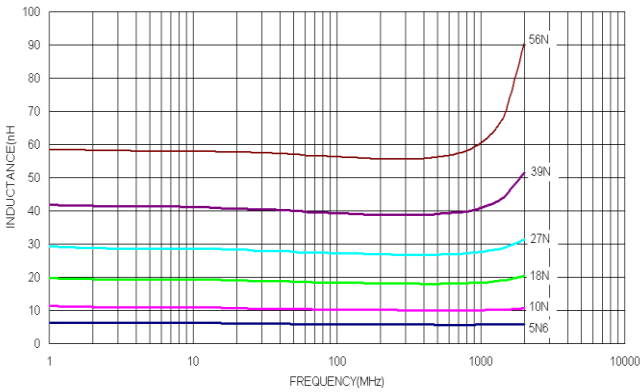

Typical **Q** vs. **F** Frequency

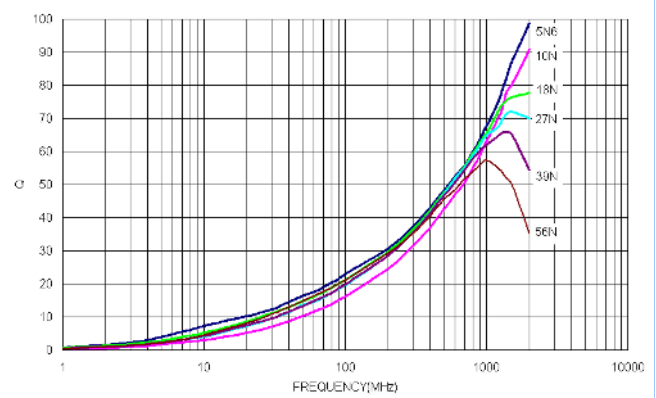

**BWCT00231711**

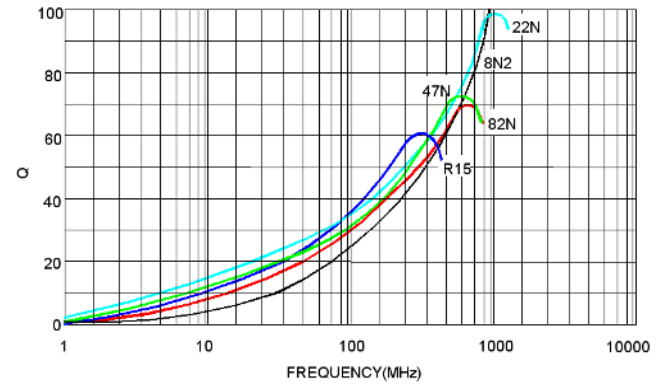
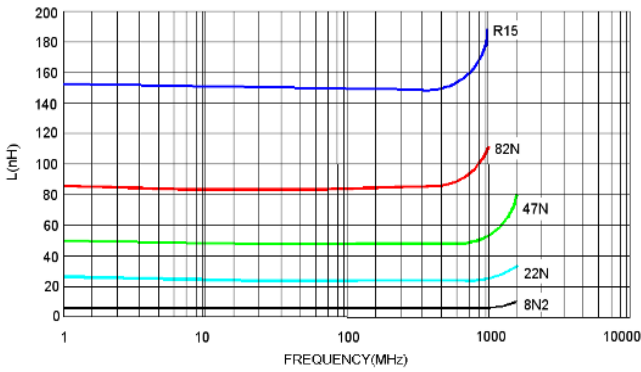

Please be sure to request approval specifications that provide further details of the products. Kindly note that the content of these specifications are subject to change or may be discontinued without prior notice. This product may not be designed/used in medical or high risk applications without Chilisin approval. Please contact our sales department before ordering.

# SMD Wire Wound Ceramic Chip Inductors - BWCT Series

## Packaging Specifications

### Tape Dimensions

Figure 1

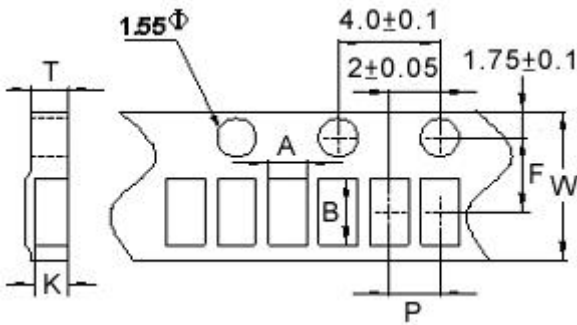

### Tape Material

Carrier Tape: Paper  
Cover Tape: Polystyrene

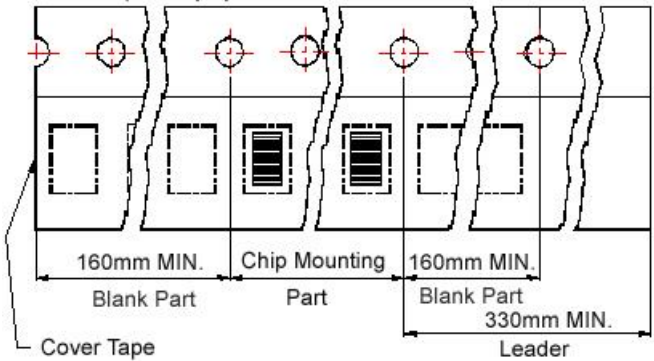
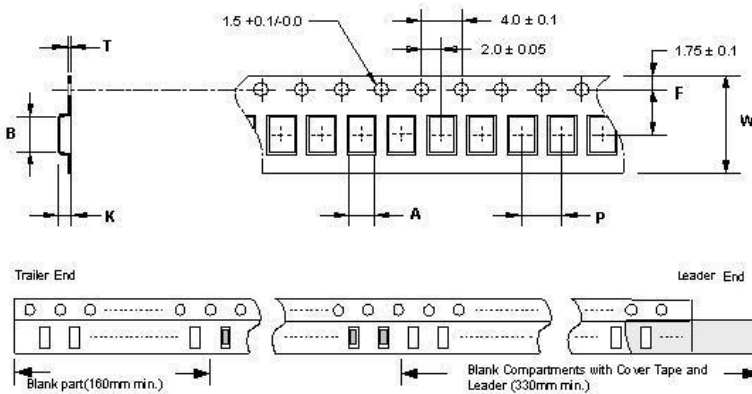
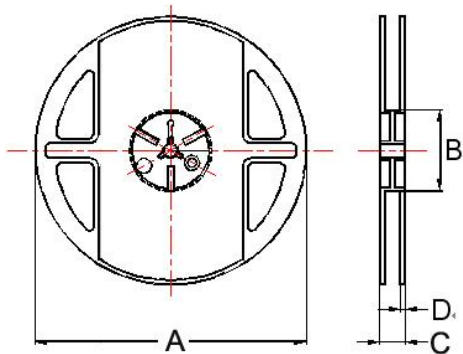

Figure 2



### Reel Dimensions



### Dimensions in mm

TYPE	Fig.	Tape Dimensions							Reel Dimensions				Quantity PCS / Reel
		A	B	T	W	P	F	K	A	B	C	D	
BWCT00160906	1	1.05	1.80	0.75	8	4	3.5	0.60	178	60	12	1.5	4000
BWCT00231711	2	1.85	2.45	0.23	8	4	3.5	1.10	178	60	12	1.5	2000