

## **Using the TPS92075 Buck-Boost Converter**

The TPS92075EVM is a 17-W maximum, 120-VAC non-isolated dimmable LED driver. The TPS92075EVM implements a dimming solution using the TPS92075 integrated circuit from Texas Instruments. This user's guide provides electrical specifications, performance data, typical characteristic curves, schematics, printed-circuit board layout, and a bill of materials.

### **Contents**

1	Introduction .....	2
2	Description .....	2
	2.1 Typical Applications .....	2
	2.2 TPS92075 Features .....	2
3	Electrical Performance Specifications .....	3
4	Schematic .....	3
5	Performance Data and Typical Characteristic Curves – Configured as Buck-Boost .....	4
	5.1 Efficiency .....	4
	5.2 Load Regulation .....	5
	5.3 Output Ripple .....	5
	5.4 Turn On Waveform .....	6
	5.5 Turn Off Waveform .....	6
	5.6 Dimming – Lutron Triac Dimmer at One Position .....	7
	5.7 Dimming – Leviton Triac Dimmer at One Position .....	7
	5.8 Thermal Scans .....	8
	5.9 EMI Scan – 9 LEDs .....	8
	5.10 Dimmer Testing .....	10
6	Reference Design, Assembly Drawing, PCB layout, and Bill of Materials .....	11
	6.1 Reference Design, Assembly Drawing and PCB layout .....	11
	6.2 Bill of Materials .....	13
Appendix A	Table Data – Buck-Boost Configuration .....	14
Appendix B	Table Data – Buck Configuration. (Exchange Diode and Inductor, Reverse Bulk Cap Polarity) Efficiency Calculated using $P_{out} = V_{out} \times I_{out}$ .....	16
Appendix C	Connection Snap-Shot .....	17

### **List of Figures**

1	TPS92075 Buck-Boost Schematic .....	3
2	Dimming Wiring Diagram .....	4
3	TPS92075 Buck-Boost Efficiency (Input and Output Power Meter Used).....	4
4	TPS92075 Buck-Boost Regulation .....	5
5	Output Ripple ( $V_{out}$ : 35.5 V, $I_{out}$ 375 mA, THD 18.5%).....	5
6	Enable Turn On Waveform – Turn On Time ~64 ms.....	6
7	Enable Turn Off Waveform .....	6
8	Lutron Leading Edge, Output = 100 mA .....	7
9	Leviton Leading Edge, Output = 20 mA.....	7
10	Thermal Scans .....	8
11	Conducted EMI Scan, 9 LEDs .....	8
12	Typical Top Overall View .....	11
13	TPS92075 Buck-Boost Top (left) and Bottom (right) Layer Assembly Drawing.....	11

14	TPS92075 Buck-Boost Bottom Copper (PCB is Single-Sided Copper) .....	12
15	Suggested Dimming Connection .....	17

### List of Tables

1	TPS92075 Buck-Boost REF DESIGN-001 Electrical Performance Specifications .....	3
2	System Scan of 27 Highest Peaks .....	9
3	Dimmer Testing .....	10
4	Bill of Materials.....	13

## 1 Introduction

The TPS92075EVM is a 17-W maximum, 120-VAC non-isolated dimmable LED driver whose form factor is intended for A-15, A-19, A-21, A-23, R-20, R-25, R-27, R-30, R-40, PS-25, PS-30, PS-35, BR-30, BR-38, BR-40, PAR-20, PAR-30, PAR-30L, G-25, G-30, G-40, and other LED bulbs.

## 2 Description

The TPS92075EVM implements a dimming solution using the TPS92075 integrated circuit from Texas Instruments. The TPS92075 is a hybrid power factor controller with a built-in phase dimming decoder. Line cycles are analyzed continuously by an internal low power digital controller for shape and symmetry. An analog current reference is then generated and used by the power converter stage to regulate the output current. The analog reference is manipulated using control algorithms developed to optimize dimmer compatibility, power factor, and THD.

Using constant off-time control, the solution achieves a low part count, high efficiency and inherently provides variation in the switching frequency. This variation creates an emulated spread-spectrum effect easing the converters EMI signature and allowing a smaller input filter.

### 2.1 Typical Applications

Triac-compatible LED lighting, including forward and reverse phase compatibility.

### 2.2 TPS92075 Features

- Controlled reference derived PFC (Power Factor Correction)
- Integrated digital phase angle decoder
- Digital PLL with active 50-Hz, 60-Hz sync
- Phase-symmetry balancing
- Instant-On with safe mode
- Leading and trailing edge dimmer compatibility
- Dimming implemented via an analog reference
- Smooth dimming transitions
- Over-voltage protection
- Output short circuit protection
- Low BOM cost and small PCB footprint
- Patent pending digital architecture
- 6-pin SOT and 8-pin SOIC available

### 3 Electrical Performance Specifications

Table 1 presents the electrical performance specifications of the TPS92075.

**Table 1. TPS92075 Buck-Boost REF DESIGN-001 Electrical Performance Specifications<sup>(1)</sup>**

Parameter	Test Conditions	MIN	TYP	MAX	Units
<b>Input Characteristics</b>					
Input Voltage range		90	120	135	V
Maximum Input current				0.140	A
<b>Output Characteristics</b>					
Output voltage, VOUT	Output current will change with LED stack. Nominal output is 35V, 360mA (12.6W)	18		50	V
Output voltage regulation	Line Regulation: Input voltage = 110 to 130		±4		%
	Line Regulation: Input voltage = 90 to 135		±8		%
Output voltage ripple	120Hz LED Ripple, typical with 35V output		300		mApp
<b>Systems Characteristics</b>					
Switching frequency			100		kHz
Peak efficiency			88		%
Peak Power Factor			.986		
Operating temperature			25	125	°C
Solution Volume			18.5		cm <sup>3</sup>
Solution Volume per Watt	Based on 17W maximum		1.1		W/cm <sup>3</sup>

<sup>(1)</sup> All performance results are for this design configuration only. Many opportunities exist to balance one performance factor for another in this design.

### 4 Schematic

Figure 1 is the EVM schematic, and Figure 2 shows suggested dimming connections.

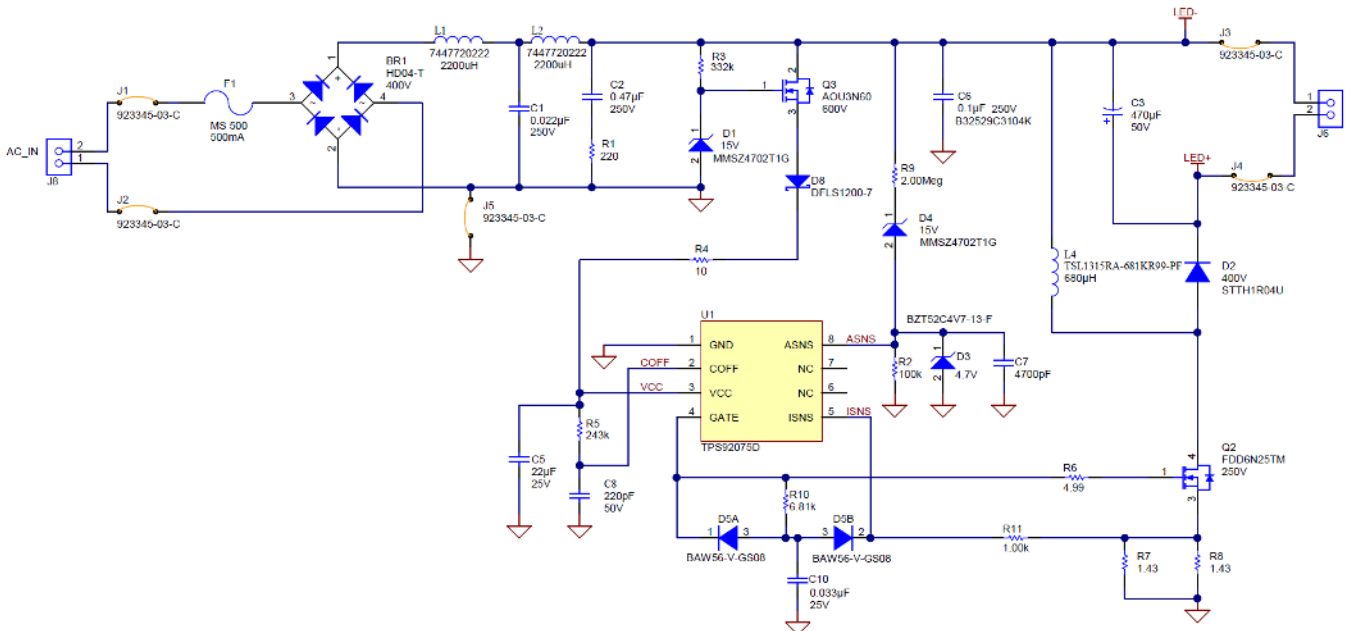

**Figure 1. TPS92075 Buck-Boost Schematic**

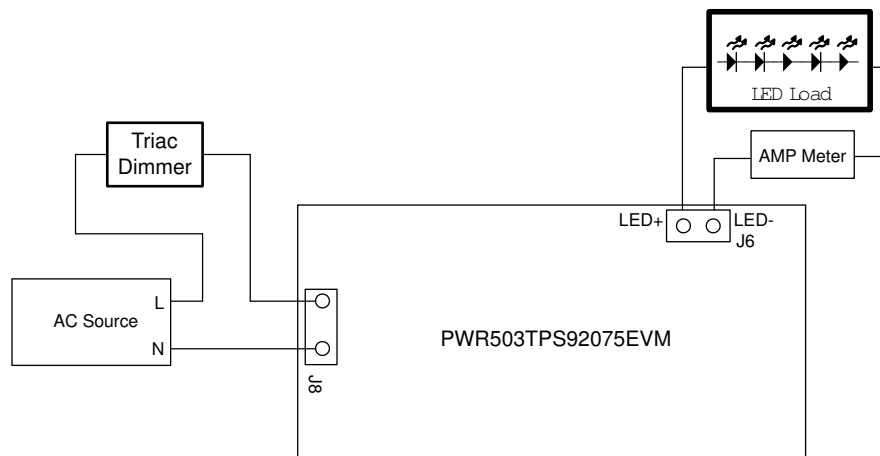

Figure 2. Dimming Wiring Diagram

## 5 Performance Data and Typical Characteristic Curves – Configured as Buck-Boost

**Note:** 18-V stack; ~8-W, 46-V Stack; ~14-W Only LED stack voltage changed, EVM design left intact for all curves

### 5.1 Efficiency

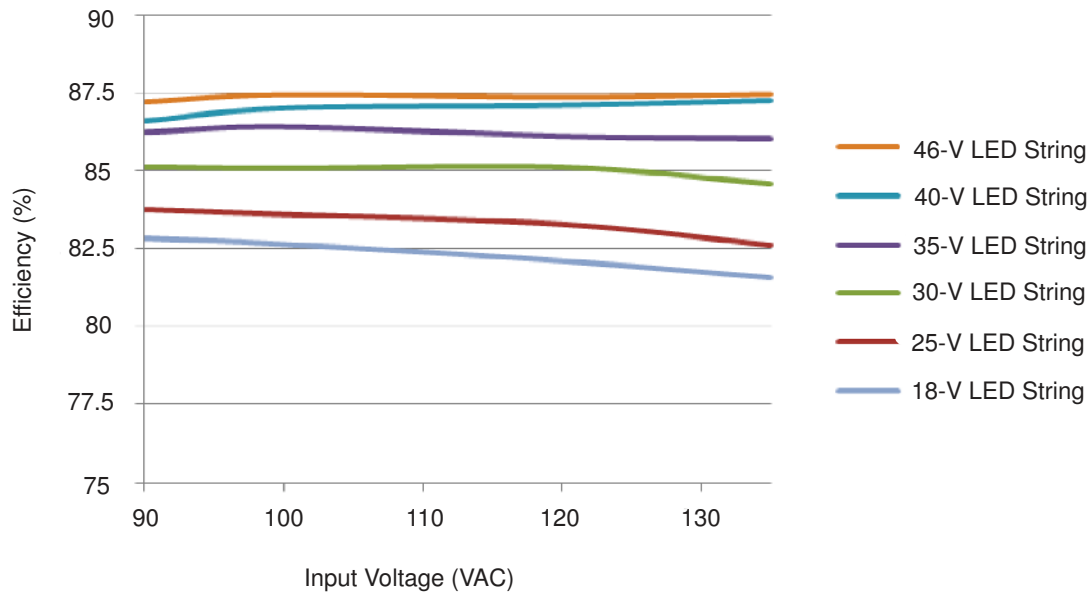

Figure 3. TPS92075 Buck-Boost Efficiency (Input and Output Power Meter Used)

### 5.2 Load Regulation

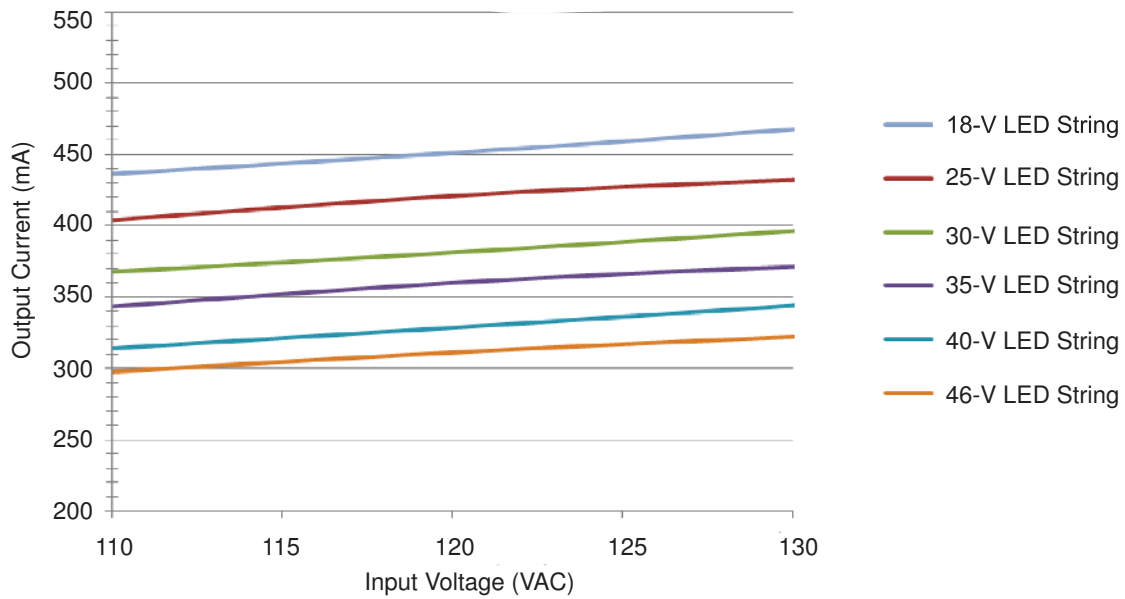
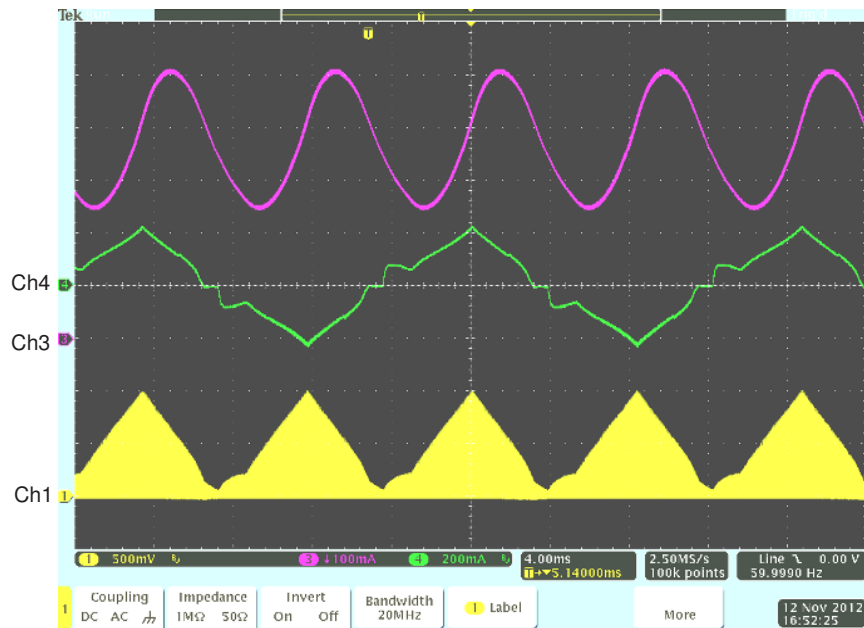

Figure 4. TPS92075 Buck-Boost Regulation

### 5.3 Output Ripple



Ch1: FET Q2 Source Ch3: LED Current Ch4: Input Current

Figure 5. Output Ripple (Vout: 35.5 V, Iout 375 mA, THD 18.5%)

### 5.4 Turn On Waveform

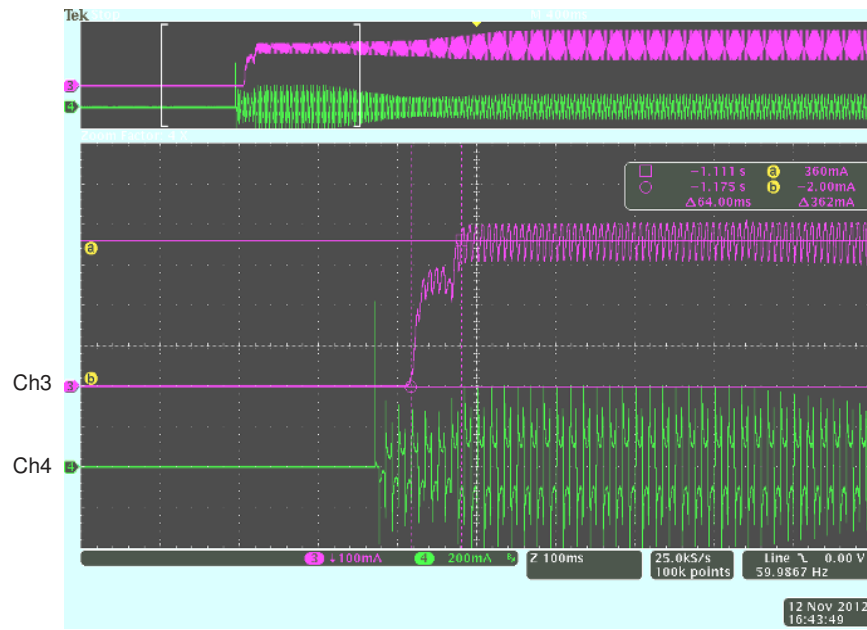

Figure 6. Enable Turn On Waveform – Turn On Time ~64 ms

### 5.5 Turn Off Waveform

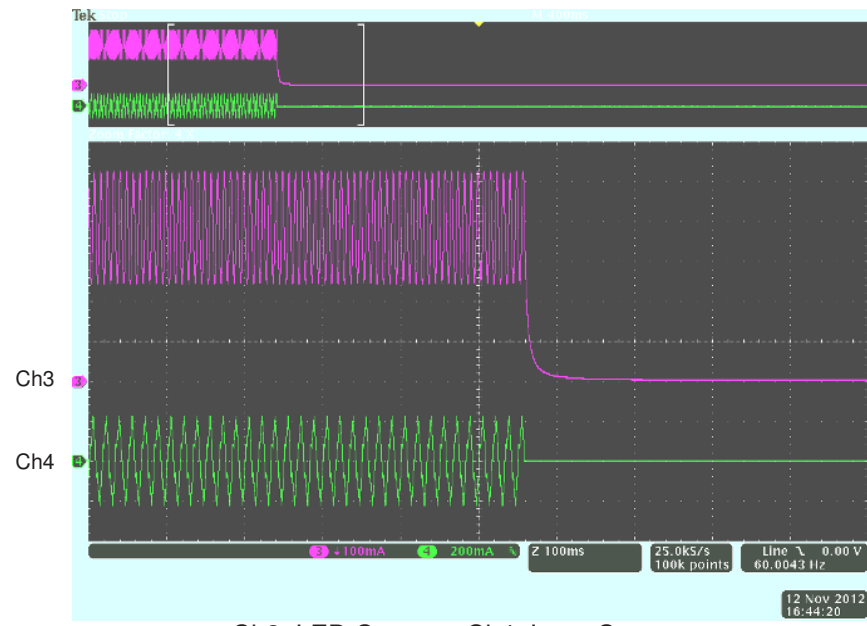
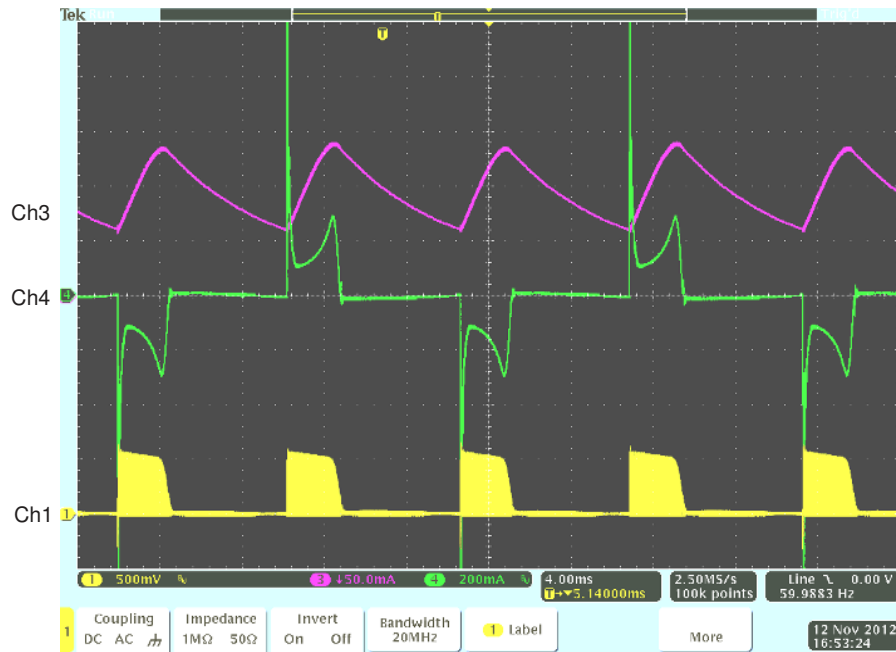

Figure 7. Enable Turn Off Waveform

### 5.6 Dimming – Lutron Triac Dimmer at One Position



Ch1: FET Q2 Source Ch3: LED Current Ch4: Input Current

**Figure 8. Lutron Leading Edge, Output = 100 mA**

### 5.7 Dimming – Leviton Triac Dimmer at One Position

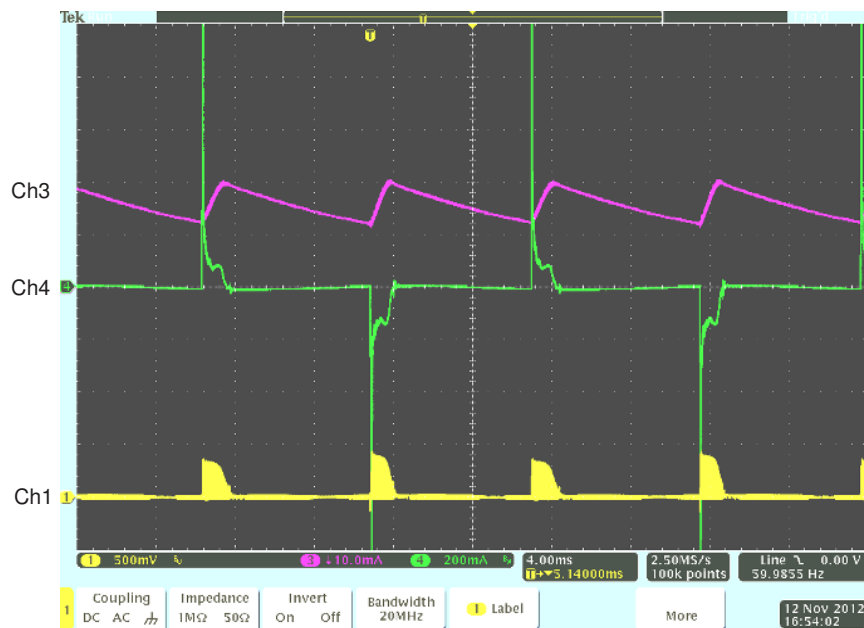

Ch1: FET Q2 Source Ch3: LED Current Ch4: Input Current

**Figure 9. Leviton Leading Edge, Output = 20 mA**

### 5.8 Thermal Scans

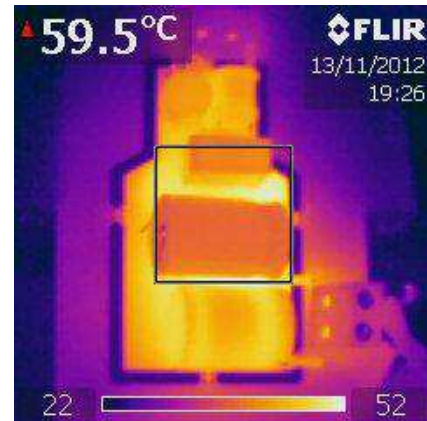
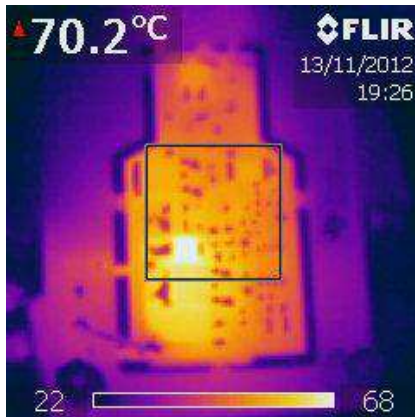

Thermal Scan 1: 20-Minute Soak, 36-V LED Stack, Top View, Hottest Point in Box: 70.2°C

Thermal Scan 2: 20-Minute Soak, 36-V LED Stack, Top View, Hottest Point in Box: 59.5°C

Figure 10. Thermal Scans

### 5.9 EMI Scan – 9 LEDs

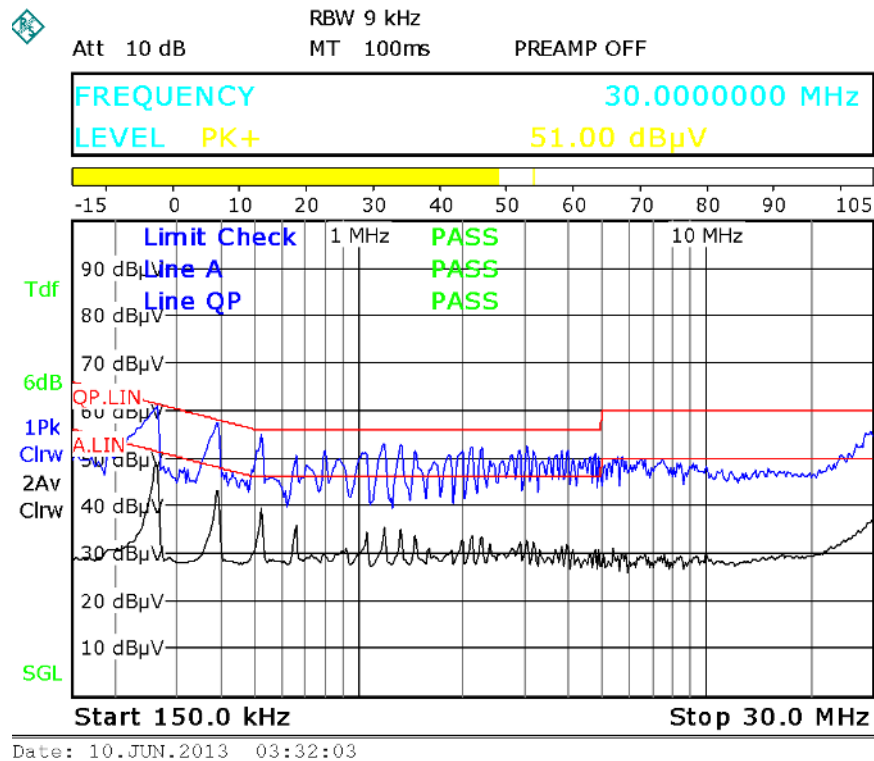

Blue Trace: Peak, Black Trace: Average

Figure 11. Conducted EMI Scan, 9 LEDs



**Table 2. System Scan of 27 Highest Peaks**

Peak #	Limit	Frequency (Hz)	Level (dB)	Margin (dB)
1	QP	262000	58.9	-2.8
2	AV	262000	48.37	-3
3	QP	394000	54.95	-3
4	AV	394000	42.69	-5.3
5	QP	526000	51.45	-4.6
6	QP	798000	42.25	-13.8
7	QP	1042000	47.07	-8.9
8	QP	1186000	48.71	-7.3
9	QP	1326000	50.23	-5.8
10	QP	1458000	48.14	-7.9
11	QP	1958000	45.66	-10.3
12	QP	2110000	46.6	-9.4
13	QP	2258000	48.92	-7.1
14	QP	2746000	44.71	-11.3
15	QP	2906000	46.93	-9.1
16	QP	3058000	49.22	-6.8
17	QP	3190000	47.93	-8.1
18	QP	3678000	44.55	-11.5
19	QP	3846000	46.77	-9.2
20	QP	3990000	48.4	-7.6
21	QP	4782000	46.62	-9.4
22	QP	28686000	46.82	-13.2
23	QP	28838000	46.86	-13.1
24	QP	29178000	47.75	-12.3
25	QP	29342000	47.72	-12.3
26	QP	29654000	48.22	-11.8
27	QP	29950000	49.31	-10.7

---

**NOTE:** When using unshielded inductors it is important that the devices sit in perpendicular planes. If the input filter inductors are not positioned at right angles conducted emissions will increase.

---

## 5.10 Dimmer Testing

**Table 3. Dimmer Testing**

Conditions: 120 VAC, 12 LEDs in series				Max lout with no dimmer = 375 mA			
Mfg:	Series:	Flicker-Free Steady State	Flicker-Free Steady State	Max lout	Min lout	Max lout	Min lout
		1 Lamp	3 Lamps	1 Lamp	1 Lamp	3 Lamps	3 Lamps
Leviton	Decora	y	y	357	0	348	0
Leviton	R52-06161-00W	y	y	308	0	303	0
Lutron	Skylark Contour	y	y	260	62	252	56
Lutron	Abella	y	y	292	22	289	19
Lutron	Maestro Duo	y	y	255	55	248	50
Lutron	Maestro Duo	y	y	296	102	288	97
Lutron	Skylark Contour	y	y	290	0	287	0
Lutron	Skylark Contour	y	y	306	45	300	41
Lutron	Toggler	y	y	324	37	319	34
Lutron	Toggler	y	y	307	56	296	51
Lutron	Maestro Duo	y	y	300	21	287	18
Lutron	Skylark Contour	y	y	305	50	296	46
Leviton	Decora	y	y	362	0	352	0
Lutron	Skylark Contour	y	y	298	19	288	17
Leviton	Decora	y	y	315	0	305	0
Leviton	Rotary	y	y	370	0	356	0
Lutron	Diva	y	y	300	78	295	73
Lutron	Skylark Contour	y	y	276	40	275	39
Lutron	Rotary	y	y	287	0	288	0
Leviton	Sureslide	y	y	307	0	305	0

## 6 Reference Design, Assembly Drawing, PCB layout, and Bill of Materials

### 6.1 Reference Design, Assembly Drawing and PCB layout

Figure 12 to Figure 14

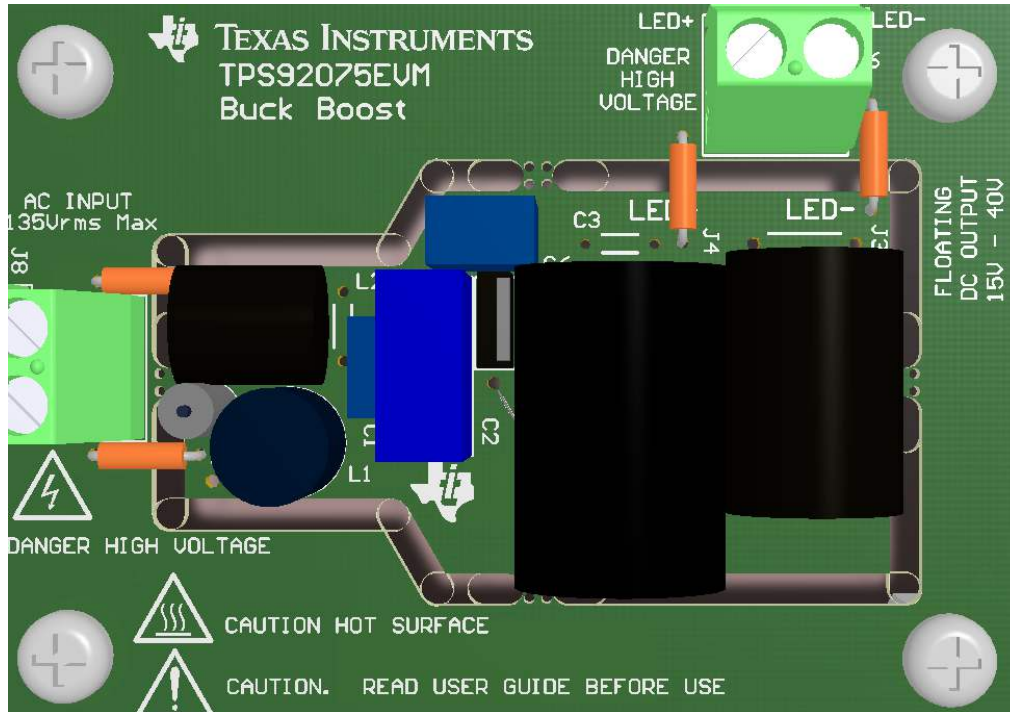

Figure 12. Typical Top Overall View

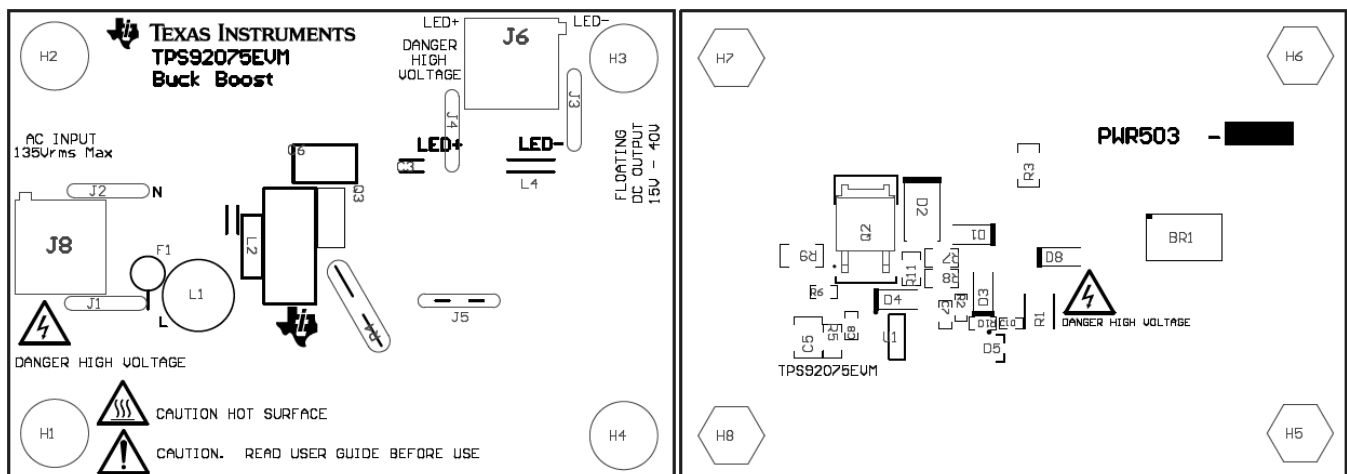

Figure 13. TPS92075 Buck-Boost Top (left) and Bottom (right) Layer Assembly Drawing

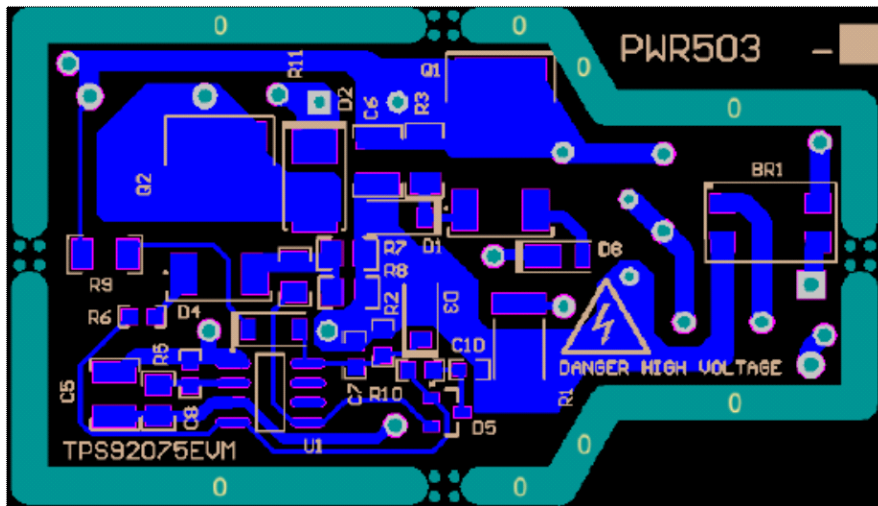

Figure 14. TPS92075 Buck-Boost Bottom Copper (PCB is Single-Sided Copper)

## 6.2 Bill of Materials

**Table 4. Bill of Materials**

Qty	Designator	Description	Manufacturer	Part Number
1	U1	Triac Dimmable Offline LED Driver	Texas Instruments	TPS92075
1	BR1	Diode, Switching-Bridge, 400V, 0.8A, MiniDIP	Diodes Inc.	HD04-T
1	C1	CAP FILM 0.022uF 250VDC RADIAL	TDK/EPCOS Inc	B32529C3223J
1	C2	CAP FILM 0.47uF 250VDC RADIAL	TDK/EPCOS Inc	B32521C3474K
1	C3	CAP ALUM 470uF 50V 7khr-105 20% RAD	Nichicon	UPW1H471MHD
1	C5	CAP CER 22uF 25V 20% X7R 1210	Taiyo Yuden	TMK325B7226MM-TR
1	C6	CAP FILM 0.1uF 250VDC RADIAL	EPCOS	B32529C3104K289
1	C7	CAP CER 4700pF, 25V, +/-10%, X7R, 0603	MuRata	GRM188R71E472KA01D
1	C8	CAP CER 220pF, 50V, 5%,NP0, 0603	MuRata	GRM1885C1H221JA01D
1	C10	CAP CER 0.033uF 25V 20% X7R 0603	TDK Corporation	C1608X7R1E333M
2	D1, D4	Diode, Zener, 15V, 500mW, SOD-123	ON Semiconductor	MMSZ4702T1G
1	D2	DIODE ULT FAST 400V 1A SMB	STMicroelectronics	STTH1R04U
1	D3	DIODE ZENER 4.7V 500MW SOD-123	Diodes Inc	BZT52C4V7-13-F
1	D5	BAW56-V-GS08CT-ND	Vishay	BAW56-V-GS08
1	D8	Diode, Schottky, 200V, 1A, PowerDI123	Diodes Inc.	DFLS1200-7
1	F1	FUSE 500mA 125V SLOW AXL BULK MS	Bel Fuse Inc	MS 500
2	L1, L2	INDUCTOR 2200uH .16A 8075 RAD	Würth Electronics	7447720222
1	L4	INDUCTOR 680uH RADIAL	TDK Corporation	TSL1315RA-681KR99-PF
2	Q1, Q2	MOSFET N-CH 250V 4.4A DPAK	Fairchild	FDD6N25TM
1	R1	RES 220 OHM 1W 5% 2512 SMD	Vishay Dale	CRCW2512220RJNEG
1	R2	RES, 100k ohm, 1%, 0.1W, 0603	Vishay-Dale	CRCW0603100KFKEA
1	R3	RES, 332k ohm, 1%, 0.25W, 1206	Vishay-Dale	CRCW1206332KFKEA
1	R4	RES 10.0 OHM 1/4W 1% AXIAL	Vishay Dale	CMF5010R000FHEB
1	R5	RES, 243k ohm, 1%, 0.125W, 0805	Vishay-Dale	CRCW0805243KFKEA
1	R6	RES, 4.99 ohm, 1%, 0.1W, 0603	Yageo America	RC0603FR-074R99L
2	R7, R8	RES 1.43 OHM 1/8W 1% 0805 SMD	Vishay Dale	CRCW08051R43FKEA
1	R9	RES, 2.00Meg ohm, 1%, 0.25W, 1206	Vishay-Dale	CRCW12062M00FKEA
1	R10	RES, 6.81k ohm, 1%, 0.1W, 0603	Vishay-Dale	CRCW06036K81FKEA
1	R11	RES, 1.00k ohm, 1%, 0.125W, 0805	Vishay-Dale	CRCW08051K00FKEA
<b>Hardware for EVM</b>				
4	H1, H2, H3, H4	Machine Screw, Round, #4-40 x 1/4, Nylon	B&F Fastener	NY PMS 440 0025 PH
4	H5, H6, H7, H8	Standoff, Hex, 0.5"L #4-40 Nylon	Keystone	1902C
1	H15	RTV167 Adhesive Sealant	Momentive	RTV167
5	J1, J2, J3, J4, J5	Jumper 300mil spacing, Orange, 200pc	3M	923345-03-C
2	J6, J8	Conn Term Block, 2POS, 5.08mm PCB	Würth Electronics	691212710002

## Appendix A Table Data – Buck-Boost Configuration

Pout Eff = Efficiency Calculated using Pout = Pout reading on power meter

Calc Pout Eff = Efficiency Calculated using Pout = Vout × Iout

<b>Test Data ~12V LED Load</b>											
Input Measurement					Load Measurement				Calculation		
Vin (Vrms)	Iin (mA Arms)	Pin (W)	PF	%THD	Vout (Vdc)	Iout (mA dc)	Pout Meas (W)	Pout Eff (%)	Pout Calc (W)	Calc Pout Eff (%)	Loss (W)
90	0.083	7.17	0.978	20.7	12.21	454	5.68	79.2	5.54	77.3	1.49
100	0.078	7.47	0.974	21.6	12.23	467	5.86	78.4	5.71	76.5	1.61
120	0.072	8.07	0.961	23.6	12.28	496	6.25	77.4	6.09	75.5	1.82
135	0.068	8.43	0.944	24.8	12.3	510	6.44	76.4	6.27	74.4	1.99
<b>Test Data ~18V LED Load</b>											
Input Measurement					Load Measurement				Calculation		
Vin (Vrms)	Iin (mA Arms)	Pin (W)	PF	%THD	Vout (Vdc)	Iout (mA dc)	Pout Meas (W)	Pout Eff (%)	Pout Calc (W)	Calc Pout Eff (%)	Loss (W)
90	0.104	9.04	0.982	18.8	18.08	407	7.49	82.9	7.36	81.4	1.55
100	0.097	9.4	0.984	17.8	18.11	422	7.77	82.7	7.64	81.3	1.63
120	0.088	10.17	0.982	18.2	18.18	451	8.35	82.1	8.20	80.6	1.82
135	0.084	10.84	0.977	19.6	18.23	476	8.84	81.5	8.68	80.1	2
<b>Test Data ~25V LED Load</b>											
Input Measurement					Load Measurement				Calculation		
Vin (Vrms)	Iin (mA Arms)	Pin (W)	PF	%THD	Vout (Vdc)	Iout (mA dc)	Pout Meas (W)	Pout Eff (%)	Pout Calc (W)	Calc Pout Eff (%)	Loss (W)
90	0.12	10.46	0.978	20.1	23.81	368	8.86	84.7	8.76	83.8	1.6
100	0.114	11.02	0.984	17.1	23.87	386	9.33	84.7	9.21	83.6	1.69
120	0.104	12.12	0.985	17.7	23.98	421	10.23	84.4	10.10	83.3	1.89
135	0.097	12.7	0.985	16.7	24.01	437	10.65	83.9	10.49	82.6	2.05
<b>Test Data ~30V LED Load</b>											
Input Measurement					Load Measurement				Calculation		
Vin (Vrms)	Iin (mA Arms)	Pin (W)	PF	%THD	Vout (Vdc)	Iout (mA dc)	Pout Meas (W)	Pout Eff (%)	Pout Calc (W)	Calc Pout Eff (%)	Loss (W)
90	0.135	11.67	0.974	21.8	29.56	336	10.02	85.9	9.93	85.1	1.65
100	0.127	12.33	0.981	19.1	29.63	354	10.6	86.0	10.49	85.1	1.73
120	0.115	13.31	0.984	17.8	29.73	381	11.43	85.9	11.33	85.1	1.88
135	0.109	14.24	0.986	16.8	29.82	404	12.2	85.7	12.05	84.6	2.04
<b>Test Data ~35V LED Load</b>											
Input Measurement					Load Measurement				Calculation		
Vin (Vrms)	Iin (mA Arms)	Pin (W)	PF	%THD	Vout (Vdc)	Iout (mA dc)	Pout Meas (W)	Pout Eff (%)	Pout Calc (W)	Calc Pout Eff (%)	Loss (W)
90	0.146	12.63	0.973	22.2	34.91	312	10.96	86.8	10.89	86.2	1.67
100	0.137	13.2	0.976	21.3	34.99	326	11.5	87.1	11.41	86.4	1.7
120	0.127	14.7	0.982	18.8	35.16	360	12.77	86.9	12.66	86.1	1.93
135	0.118	15.4	0.984	18.2	35.23	376	13.36	86.8	13.25	86.0	2.04

<b>Test Data ~40V LED Load</b>											
Input Measurement					Load Measurement			Calculation			
Vin (Vrms)	Iin (mA <sub>rms</sub> )	Pin (W)	PF	%THD	Vout (V <sub>dc</sub> )	Iout (mA <sub>dc</sub> )	Pout Meas (W)	Pout Eff (%)	Pout Calc (W)	Calc Pout Eff (%)	Loss (W)
90	0.155	13.38	0.969	24	40.51	286	11.66	87.1	11.59	86.6	1.72
100	0.146	14	0.973	22.9	40.6	300	12.27	87.6	12.18	87.0	1.73
120	0.133	15.4	0.981	20	40.77	329	13.51	87.7	13.41	87.1	1.89
135	0.127	16.5	0.984	18.2	40.9	352	14.51	87.9	14.40	87.3	1.99

<b>Test Data ~46V LED Load</b>											
Input Measurement					Load Measurement			Calculation			
Vin (Vrms)	Iin (mA <sub>rms</sub> )	Pin (W)	PF	%THD	Vout (V <sub>dc</sub> )	Iout (mA <sub>dc</sub> )	Pout Meas (W)	Pout Eff (%)	Pout Calc (W)	Calc Pout Eff (%)	Loss (W)
90	0.162	13.9	0.963	26.3	46.1	263	12.17	87.6	12.12	87.2	1.73
100	0.156	14.97	0.969	23.7	46.26	283	13.17	88.0	13.09	87.5	1.8
120	0.143	16.54	0.977	20.6	46.47	311	14.57	88.1	14.45	87.4	1.97
135	0.134	17.41	0.982	19.3	46.57	327	15.36	88.2	15.23	87.5	2.05

## Appendix B Table Data – Buck Configuration. (Exchange Diode and Inductor, Reverse Bulk Cap Polarity) Efficiency Calculated using $P_{out} = V_{out} \times I_{out}$

<b>LED Voltage ~12V</b>							
Vin (RMS)	Pin	PF	%THD	Vout	Iout	Pout Calc	Calc Pout Eff (%)
100	8.21	0.977	20.5	12.55	0.516	6.476	78.88
120	8.87	0.965	22.53	12.58	0.547	6.881	77.58
135	8.92	0.953	24.26	12.63	0.57	7.199	80.71
<b>LED Voltage ~18V</b>							
Vin (RMS)	Pin	PF	%THD	Vout	Iout	Pout Calc	Calc Pout Eff (%)
100	10.68	0.984	17.72	18.46	0.485	8.953	83.83
120	11.39	0.985	16.25	18.56	0.51	9.466	83.10
135	12.05	0.981	16.95	18.64	0.533	9.935	82.45
<b>LED Voltage ~25V</b>							
Vin (RMS)	Pin	PF	%THD	Vout	Iout	Pout Calc	Calc Pout Eff (%)
100	12.75	0.979	19.62	24.12	0.456	10.999	86.26
120	13.61	0.988	15.49	24.25	0.482	11.689	85.88
135	14.4	0.989	14.28	24.36	0.505	12.302	85.43
<b>LED Voltage ~30V</b>							
Vin (RMS)	Pin	PF	%THD	Vout	Iout	Pout Calc	Calc Pout Eff (%)
100	14.58	0.974	21.94	29.43	0.435	12.802	87.81
120	15.77	0.984	17.35	29.63	0.467	13.837	87.74
135	16.24	0.988	15.68	29.67	0.478	14.182	87.33
<b>LED Voltage ~35V</b>							
Vin (RMS)	Pin	PF	%THD	Vout	Iout	Pout Calc	Calc Pout Eff (%)
100	16.19	0.967	24.99	34.76	0.414	14.391	88.89
120	17.51	0.98	19.52	34.89	0.446	15.561	88.87
135	17.35	0.985	17.33	35.08	0.457	16.032	92.40
<b>LED Voltage ~40V</b>							
Vin (RMS)	Pin	PF	%THD	Vout	Iout	Pout Calc	Calc Pout Eff (%)
100	17.77	0.958	28.46	40.69	0.392	15.950	89.76
120	19.32	0.974	22.24	41.04	0.423	17.360	89.85
135	19.94	0.981	19.56	41.12	0.435	17.887	89.71
<b>LED Voltage ~46V</b>							
Vin (RMS)	Pin	PF	%THD	Vout	Iout	Pout Calc	Calc Pout Eff (%)
100	18.96	0.95	31.46	45.74	0.374	17.107	90.23
120	20.69	0.968	24.68	46.16	0.405	18.695	90.36
135	21.36	0.976	21.67	46.25	0.417	19.286	90.29



## Appendix C Connection Snap-Shot

Figure 15 illustrates a typical dimming connection.

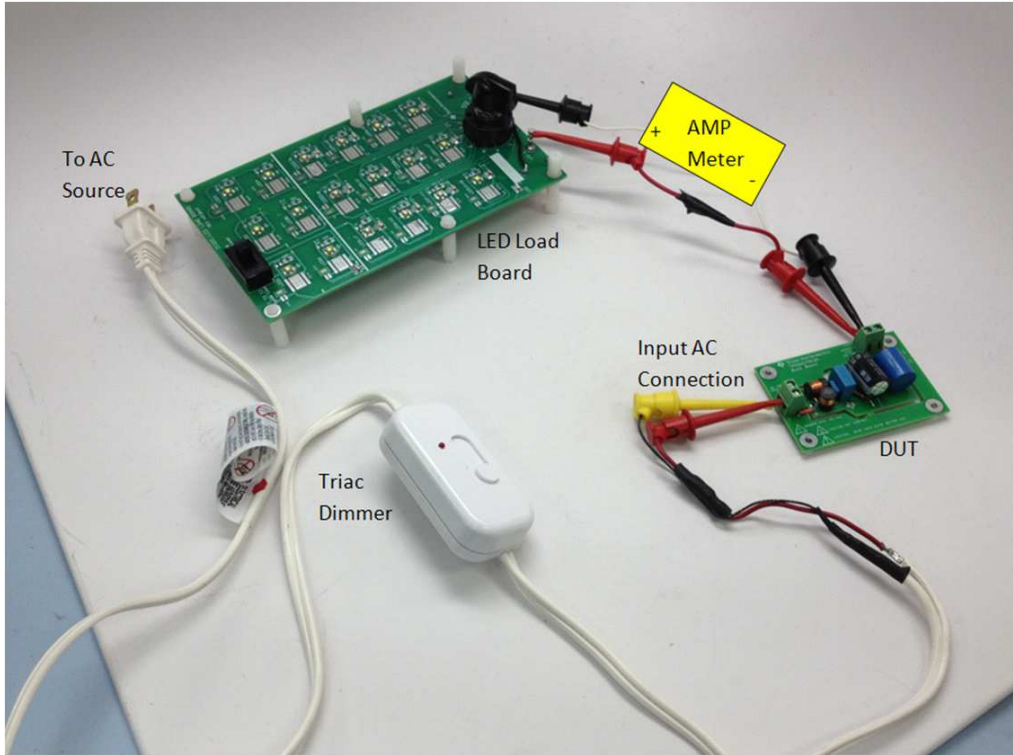

Remove the dimmer for a non-dimming setup.

**Figure 15. Suggested Dimming Connection**

## IMPORTANT NOTICE

Texas Instruments Incorporated and its subsidiaries (TI) reserve the right to make corrections, enhancements, improvements and other changes to its semiconductor products and services per JESD46, latest issue, and to discontinue any product or service per JESD48, latest issue. Buyers should obtain the latest relevant information before placing orders and should verify that such information is current and complete. All semiconductor products (also referred to herein as "components") are sold subject to TI's terms and conditions of sale supplied at the time of order acknowledgment.

TI warrants performance of its components to the specifications applicable at the time of sale, in accordance with the warranty in TI's terms and conditions of sale of semiconductor products. Testing and other quality control techniques are used to the extent TI deems necessary to support this warranty. Except where mandated by applicable law, testing of all parameters of each component is not necessarily performed.

TI assumes no liability for applications assistance or the design of Buyers' products. Buyers are responsible for their products and applications using TI components. To minimize the risks associated with Buyers' products and applications, Buyers should provide adequate design and operating safeguards.

TI does not warrant or represent that any license, either express or implied, is granted under any patent right, copyright, mask work right, or other intellectual property right relating to any combination, machine, or process in which TI components or services are used. Information published by TI regarding third-party products or services does not constitute a license to use such products or services or a warranty or endorsement thereof. Use of such information may require a license from a third party under the patents or other intellectual property of the third party, or a license from TI under the patents or other intellectual property of TI.

Reproduction of significant portions of TI information in TI data books or data sheets is permissible only if reproduction is without alteration and is accompanied by all associated warranties, conditions, limitations, and notices. TI is not responsible or liable for such altered documentation. Information of third parties may be subject to additional restrictions.

Resale of TI components or services with statements different from or beyond the parameters stated by TI for that component or service voids all express and any implied warranties for the associated TI component or service and is an unfair and deceptive business practice. TI is not responsible or liable for any such statements.

Buyer acknowledges and agrees that it is solely responsible for compliance with all legal, regulatory and safety-related requirements concerning its products, and any use of TI components in its applications, notwithstanding any applications-related information or support that may be provided by TI. Buyer represents and agrees that it has all the necessary expertise to create and implement safeguards which anticipate dangerous consequences of failures, monitor failures and their consequences, lessen the likelihood of failures that might cause harm and take appropriate remedial actions. Buyer will fully indemnify TI and its representatives against any damages arising out of the use of any TI components in safety-critical applications.

In some cases, TI components may be promoted specifically to facilitate safety-related applications. With such components, TI's goal is to help enable customers to design and create their own end-product solutions that meet applicable functional safety standards and requirements. Nonetheless, such components are subject to these terms.

No TI components are authorized for use in FDA Class III (or similar life-critical medical equipment) unless authorized officers of the parties have executed a special agreement specifically governing such use.

Only those TI components which TI has specifically designated as military grade or "enhanced plastic" are designed and intended for use in military/aerospace applications or environments. Buyer acknowledges and agrees that any military or aerospace use of TI components which have **not** been so designated is solely at the Buyer's risk, and that Buyer is solely responsible for compliance with all legal and regulatory requirements in connection with such use.

TI has specifically designated certain components as meeting ISO/TS16949 requirements, mainly for automotive use. In any case of use of non-designated products, TI will not be responsible for any failure to meet ISO/TS16949.

### Products

Audio	<a href="http://www.ti.com/audio">www.ti.com/audio</a>
Amplifiers	<a href="http://amplifier.ti.com">amplifier.ti.com</a>
Data Converters	<a href="http://dataconverter.ti.com">dataconverter.ti.com</a>
DLP® Products	<a href="http://www.dlp.com">www.dlp.com</a>
DSP	<a href="http://dsp.ti.com">dsp.ti.com</a>
Clocks and Timers	<a href="http://www.ti.com/clocks">www.ti.com/clocks</a>
Interface	<a href="http://interface.ti.com">interface.ti.com</a>
Logic	<a href="http://logic.ti.com">logic.ti.com</a>
Power Mgmt	<a href="http://power.ti.com">power.ti.com</a>
Microcontrollers	<a href="http://microcontroller.ti.com">microcontroller.ti.com</a>
RFID	<a href="http://www.ti-rfid.com">www.ti-rfid.com</a>
OMAP Applications Processors	<a href="http://www.ti.com/omap">www.ti.com/omap</a>
Wireless Connectivity	<a href="http://www.ti.com/wirelessconnectivity">www.ti.com/wirelessconnectivity</a>

### Applications

Automotive and Transportation	<a href="http://www.ti.com/automotive">www.ti.com/automotive</a>
Communications and Telecom	<a href="http://www.ti.com/communications">www.ti.com/communications</a>
Computers and Peripherals	<a href="http://www.ti.com/computers">www.ti.com/computers</a>
Consumer Electronics	<a href="http://www.ti.com/consumer-apps">www.ti.com/consumer-apps</a>
Energy and Lighting	<a href="http://www.ti.com/energy">www.ti.com/energy</a>
Industrial	<a href="http://www.ti.com/industrial">www.ti.com/industrial</a>
Medical	<a href="http://www.ti.com/medical">www.ti.com/medical</a>
Security	<a href="http://www.ti.com/security">www.ti.com/security</a>
Space, Avionics and Defense	<a href="http://www.ti.com/space-avionics-defense">www.ti.com/space-avionics-defense</a>
Video and Imaging	<a href="http://www.ti.com/video">www.ti.com/video</a>

### TI E2E Community

[e2e.ti.com](http://e2e.ti.com)